

El Paso County Stormwater Master Plan

August 2010

Prepared for:

El Paso Water Utilities
1154 Hawkins Boulevard
El Paso, Texas 79961



Texas Water Development Board
1700 N. Congress Avenue
Austin, TX 78711

and

El Paso County
500 E. San Antonio
El Paso, TX 79901



Prepared by:

URS Corporation
Austin, TX, Albuquerque, NM



Table of Contents

<u>Section</u>	<u>Page</u>
EXECUTIVE SUMMARY	ES-1
1.0 INTRODUCTION	1-1
2.0 SCOPE OF MASTER PLAN	2-1
2.1 Stormwater Master Plan Overview	2-1
2.2 Technical Standards and Assumptions Impacting the Plan	2-2
2.3 Public Meetings and Technical Working Meetings	2-2
3.0 OVERVIEW OF DRAINAGE SYSTEMS	3-1
3.1 Vinton Study Area	3-1
3.1.1 Site Topography	3-1
3.1.2 Site Surficial Geology	3-2
3.1.3 Residential/Commercial Development	3-2
3.2 Canutillo Study Area	3-2
3.2.1 Site Topography	3-2
3.2.2 Site Surficial Geology	3-3
3.2.3 Residential/Commercial Development	3-3
3.3 Sparks Arroyo and Sub Basin A Study Area	3-3
3.3.1 Site Topography	3-3
3.3.2 Site Surficial Geology	3-3
3.3.3 Residential/Commercial Development	3-3
3.4 Socorro Study Area	3-4
3.4.1 Site Topography	3-4
3.4.2 Site Surficial Geology	3-4
3.4.3 Residential/Commercial Development	3-4
3.5 Hacienda Real Study Area	3-5
3.5.1 Site Topography	3-5
3.5.2 Site Surficial Geology	3-5
3.5.3 Residential/Commercial Development	3-5
3.6 Fabens Study Area	3-5
3.6.1 Site Topography	3-5
3.6.2 Site Surficial Geology	3-6
3.6.3 Residential/Commercial Development	3-6
3.7 Tornillo Study Area	3-6
3.7.1 Site Topography	3-6
3.7.2 Site Surficial Geology	3-7
3.7.3 Residential/Commercial Development	3-7
4.0 MASTER PLAN METHODOLOGY	4-1
4.1 Review of Historical Flooding and Prior/Ongoing Studies	4-2
4.1.1 Vinton Study Area	4-3

4.1.2	Canutillo Study Area	4-3
4.1.3	Sparks Arroyo and Sub Basin A Study Area	4-4
4.1.4	Socorro Study Area	4-4
4.1.5	Hacienda Real Study Area	4-4
4.1.6	Fabens Study Area	4-5
4.1.7	Tornillo Study Area	4-5
4.2	Hydrology	4-5
4.3	Hydraulics	4-5
4.4	Working Meetings	4-5
4.5	Problem Area Definitions	4-6
4.6	Development of Project Alternatives	4-6
4.7	Alternatives Evaluation	4-7
4.8	Alternatives Selection	4-7
4.9	Prioritization	4-7
5.0	IDENTIFIED PROBLEM AREAS	5-1
5.1	Vinton Study Area	5-1
5.1.1	VIN1	5-2
5.1.2	VIN2	5-2
5.1.3	VIN3	5-2
5.1.4	VIN4	5-2
5.1.5	VIN5	5-3
5.1.6	VIN6	5-3
5.1.7	VIN7	5-3
5.1.8	VIN8	5-3
5.1.9	VIN9	5-3
5.1.10	VIN10	5-4
5.1.11	VIN11	5-4
5.1.12	VIN12	5-4
5.1.13	VIN13	5-4
5.1.14	VIN14	5-4
5.2	Canutillo Study Area	5-4
5.2.1	CAN1	5-5
5.2.2	CAN2	5-5
5.2.3	CAN3	5-6
5.3	Sparks Arroyo and Sub Basin A Study Area	5-6
5.3.1	SSA1	5-6
5.3.2	SSA2	5-7
5.3.3	SSA3	5-7
5.3.4	SSA4	5-7
5.3.5	SSA5	5-7
5.3.6	SSA6	5-8
5.3.7	SSA7	5-8
5.4	Socorro Study Area	5-8
5.4.1	SOC1	5-9
5.4.2	SOC2	5-9

5.4.3	SOC3.....	5-9
5.4.4	SOC4.....	5-10
5.4.5	SOC5.....	5-10
5.4.6	SOC6.....	5-10
5.4.7	SOC7.....	5-10
5.4.8	SOC8.....	5-10
5.5	Hacienda Real Study Area.....	5-11
5.5.1	HAC1.....	5-11
5.5.2	HAC2.....	5-12
5.5.3	HAC3.....	5-12
5.5.4	HAC4.....	5-12
5.5.5	HAC5.....	5-12
5.5.6	HAC6.....	5-12
5.5.7	HAC7.....	5-13
5.5.8	HAC8.....	5-13
5.5.9	HAC9.....	5-13
5.5.10	HAC10.....	5-13
5.5.11	HAC11.....	5-13
5.5.12	HAC12.....	5-14
5.5.13	HAC13.....	5-14
5.5.14	HAC14.....	5-14
5.6	Fabens Study Area.....	5-14
5.6.1	FAB1.....	5-14
5.6.2	FAB2.....	5-15
5.6.3	FAB3.....	5-15
5.7	Tornillo Study Area.....	5-15
5.7.1	TOR1.....	5-16
5.7.2	TOR2.....	5-16
5.7.3	TOR3.....	5-16
5.7.4	TOR4.....	5-16
5.7.5	TOR5.....	5-17
5.7.6	TOR6.....	5-17
6.0	RECOMMENDED IMPROVEMENTS.....	6-1
6.1	Vinton Study Area.....	6-1
6.1.1	Specific Projects.....	6-1
6.1.1.1	Flow Path Number 45A Diversion (VIN1).....	6-1
6.1.1.2	Flow Path Number 45A Channel Improvements (VIN2).....	6-2
6.1.1.3	Flow Path Number 45 Upper Section (VIN3).....	6-2
6.1.1.4	Flow Path Number 45 Middle Section (VIN4).....	6-2
6.1.1.5	Flow Path Number 44 (VIN5).....	6-3
6.1.1.6	Doniphan Drive Crossing (VIN6).....	6-3
6.1.1.7	Railroad Crossing (VIN7).....	6-3
6.1.1.8	Doniphan Drive Crossing (VIN8).....	6-3
6.1.1.9	AP Ramirez Street Crossing (VIN9).....	6-3

- 6.1.1.10 Kiely Road Crossing (VIN10) 6-4
- 6.1.1.11 Quejette Road Crossing (VIN11) 6-4
- 6.1.1.12 IH-10 Northbound Off-ramp Crossing (VIN12)..... 6-4
- 6.1.1.13 Kiely Road Crossing with Flow Path Number 45A
(VIN13) 6-4
- 6.1.1.14 Iron Drive Crossing (VIN14)..... 6-4
- 6.2 Canutillo Study Area 6-5
 - 6.2.1 Specific Project 6-5
 - 6.2.1.1 Flow Path Number 42 (CAN1) 6-5
 - 6.2.1.2 Localized Flooding along First Avenue Channel
(CAN2)..... 6-5
 - 6.2.1.3 Doniphan Drive Crossing (CAN3) 6-5
- 6.3 Sparks Arroyo and Sub Basin A Study Area..... 6-6
 - 6.3.1 Specific Projects 6-6
 - 6.3.1.1 A1-A3 Basin (SSA1) 6-6
 - 6.3.1.2 A4 Basin (SSA2)..... 6-6
 - 6.3.1.3 A5-A6 Basin (SSA3) 6-7
 - 6.3.1.4 Sparks Basin (SSA4) 6-7
 - 6.3.1.5 Sparks Arroyo (SSA5)..... 6-7
 - 6.3.1.6 Sparks Ponds (SSA6) 6-7
 - 6.3.1.7 Valley Ridge Basin (SSA7) 6-8
- 6.4 Socorro Study Area 6-8
 - 6.4.1 Specific Projects 6-8
 - 6.4.1.1 El Paso Hills Basin Repair (SOC1) 6-8
 - 6.4.1.2 Stream 4 Basin (SOC2) 6-9
 - 6.4.1.3 Stream 5 Basin (SOC3) 6-9
 - 6.4.1.4 Stream 5.5 Basin (SOC4) 6-9
 - 6.4.1.5 Carr Road Crossing (SOC5)..... 6-10
 - 6.4.1.6 Coker Road Crossing (SOC6) 6-10
 - 6.4.1.7 Anderson Road Crossing (SOC7)..... 6-10
 - 6.4.1.8 Mesa Drain Crossing (SOC8) 6-10
- 6.5 Hacienda Real Study Area..... 6-10
 - 6.5.1 Specific Projects 6-11
 - 6.5.1.1 Stream 6 Basin Outlet (HAC1) 6-11
 - 6.5.1.2 Stream 7 Basins (HAC2)..... 6-11
 - 6.5.1.3 Stream 8 Basin (HAC3) 6-11
 - 6.5.1.4 Streams 9 and 10 Basin (HAC4)..... 6-12
 - 6.5.1.5 Stream 11 Basin (HAC5) 6-12
 - 6.5.1.6 Streams 12 and 13 Basin (HAC6)..... 6-12
 - 6.5.1.7 Stream 13.5 Basin (HAC7) 6-13
 - 6.5.1.8 Bridgeway Drive Crossing (HAC8)..... 6-13
 - 6.5.1.9 North Loop Drive Crossing (HAC9)..... 6-13
 - 6.5.1.10 FM 1110 Crossing (HAC10)..... 6-13
 - 6.5.1.11 Salatral Lateral Crossing (HAC11)..... 6-14
 - 6.5.1.12 Fenter Road Crossing (HAC12)..... 6-14

6.5.1.13	Dirt Road Upstream of Celum Road Crossing (HAC13)	6-14
6.5.1.14	Celum Road Crossing (HAC14)	6-14
6.6	Fabens Study Area	6-14
6.6.1	Specific Projects	6-15
6.6.1.1	Fabens North 1 Basin (FAB1)	6-15
6.6.1.2	San Felipe Arroyo (FAB2)	6-15
6.6.1.3	Fabens Dam (FAB3)	6-15
6.7	Tornillo Study Area	6-15
6.7.1	Specific Projects	6-16
6.7.1.1	High School Channel (TOR1)	6-16
6.7.1.2	High School Channel Embankment (TOR2)	6-16
6.7.1.3	Flow Path T (TOR3)	6-16
6.7.1.4	Tornillo Handle Channel 2 (TOR4)	6-16
6.7.1.5	Tornillo Handle Channel 1 (TOR5)	6-17
6.7.1.6	OT Smith Road Crossing (TOR6)	6-17
6.8	Summary	6-17
7.0	PRIORITIZATION OF SELECTED PROJECTS	7-1
8.0	COUNTYWIDE STORMWATER POLICY RECOMMENDATIONS	8-1
8.1	City and County Legal Authority to Control Drainage	8-1
8.2	Potential Inter-Jurisdictional Authority to Control Drainage	8-2
8.3	Public Information Program	8-3
8.4	Stormwater Management Information Resources	8-3
9.0	REFERENCES	9-1

List of Appendices

Appendix A	Hydrology Report
Appendix B	Hydraulics Report
Appendix C	Project Alternatives Evaluation and Selection

List of Tables

Table 6-1	Stormwater Projects	6-18
Table 7-1	Prioritization Summary	7-3

List of Figures

Figure 2-1	Master Plan Study Areas	2-4
Figure 3-1	Vinton Study Area	3-8
Figure 3-2	Canutillo Study Area	3-9
Figure 3-3	Sparks Arroyo and Sub Basin A Study Area	3-10
Figure 3-4	Socorro Study Area	3-11
Figure 3-5	Hacienda Real Study Area.....	3-12
Figure 3-6	Fabens Study Area	3-13
Figure 3-7	Tornillo Study Area	3-14
Figure 5-1	Identified Problem Areas - Vinton Study Area.....	5-18
Figure 5-2	Identified Problem Areas - Canutillo Study Area.....	5-19
Figure 5-3	Identified Problem Areas - Sparks Arroyo and Sub Basin A Study Area	5-20
Figure 5-4	Identified Problem Areas - Socorro Study Area	5-21
Figure 5-5	Identified Problem Areas - Hacienda Real Study Area	5-22
Figure 5-6	Identified Problem Areas - Fabens Study Area.....	5-23
Figure 5-7	Identified Problem Areas - Tornillo Study Area	5-24
Figure 6-1	Vinton Study Area - VIN1	6-26
Figure 6-2	Vinton Study Area - VIN1, VIN3, and VIN12	6-27
Figure 6-3	Vinton Study Area - VIN2, VIN4, VIN9 to VIN11, VIN13, and VIN14	6-28
Figure 6-4	Vinton Study Area - VIN5 and VIN6.....	6-29
Figure 6-5	Vinton Study Area - VIN7 and VIN8.....	6-30
Figure 6-6	Canutillo Study Area - CAN1	6-31
Figure 6-7	Canutillo Study Area - CAN2 and CAN3.....	6-32
Figure 6-8	Sparks Arroyo and Sub Basin A Study Area - SSA1 and SSA2	6-33
Figure 6-9	Sparks Arroyo and Sub Basin A Study Area - SSA3	6-34
Figure 6-10	Sparks Arroyo and Sub Basin A Study Area - SSA4, SSA5, and SSA6.....	6-35
Figure 6-11	Sparks Arroyo and Sub Basin A Study Area - SSA7	6-36
Figure 6-12	Socorro Study Area - SOC1.....	6-37
Figure 6-13	Socorro Study Area - SOC2.....	6-38
Figure 6-14	Socorro Study Area - SOC3.....	6-39
Figure 6-15	Socorro Study Area - SOC4.....	6-40
Figure 6-16	Socorro Study Area - SOC5 and SOC6	6-41
Figure 6-17	Socorro Study Area - SOC7 and SOC8	6-42
Figure 6-18	Hacienda Real Study Area - HAC1 and HAC3	6-43
Figure 6-19	Hacienda Real Study Area - HAC2	6-44
Figure 6-20	Hacienda Real Study Area - HAC4 and HAC5	6-45
Figure 6-21	Hacienda Real Study Area - HAC6 and HAC7	6-46
Figure 6-22	Hacienda Real Study Area - HAC8, HAC9, HAC10, HAC11, HAC12, HAC13, and HAC14.....	6-47
Figure 6-23	Fabens Study Area - FAB1 and FAB2	6-48
Figure 6-24	Fabens Study Area - FAB3	6-49
Figure 6-25	Tornillo Study Area - TOR1 to TOR3	6-50
Figure 6-26	Tornillo Study Area - TOR 4 to TOR6	6-51

Acronyms and Abbreviations

°F	Degrees Fahrenheit
%	Percent
CBC	Concrete box culvert
CIP	Capital Improvement Program
CLOMR	Conditional Letter of Map Revision
CMP	Corrugated metal pipe
DDM	Drainage Design Manual
EDAP	Economically Distressed Areas Program
EPNG	El Paso Natural Gas
EPWU	El Paso Water Utilities
ETJ	Extraterritorial Jurisdiction Areas
FEMA	Federal Emergency Management Agency
FIRM	Flood Insurance Rate Map
FIS	Flood Insurance Study
HEC-HMS	Hydrologic Engineering Center-Hydrologic Modeling System
HEC-RAS	Hydrologic Engineering Center-River Analysis System
IBWC	International Boundary and Water Commission
IH-10	Interstate Highway 10
LOMR	Letter of Map Revision
MSR	Model Subdivision Rule
No.	Number
NRCS	Natural Resources Conservation Service
PMP	Probable maximum precipitation
PSC	Parkhill, Smith, & Cooper, Inc.
PVC	Polyvinyl chloride
RCP	Reinforced concrete pipe
ROW	Right-of-way
SCS	Soil Conservation Service
SMP	Stormwater Master Plan
SSURGO	Soil Survey Geographic Database
TCEQ	Texas Commission on Environmental Quality
TR	Technical Release
TWDB	Texas Water Development Board
TxDOT	Texas Department of Transportation
URS	URS Corporation
USACE	U.S. Army Corp of Engineers
USDA	U.S. Department of Agriculture
WWTP	Wastewater Treatment Plant

EXECUTIVE SUMMARY

The El Paso County Stormwater Master Plan (SMP) (hereafter referred to as the County SMP) is a continuation of the stormwater master planning efforts that were initiated with the City of El Paso SMP (hereafter referred to as the City SMP) which was completed in 2009. The City SMP addressed stormwater needs throughout the City. As the City master plan was being completed, El Paso County recognized that a similar effort was needed to address stormwater needs throughout the rest of the County.

This SMP was a joint effort and funded by El Paso County, the Texas Water Development Board (TWDB), and El Paso Water Utilities (EPWU). This SMP focuses on developed areas of El Paso County that have experienced flooding problems ranging from localized storms to the major floods of 2006. The master planning protocols that were developed for the City SMP were used as the basis for preparing the County SMP.

Public input was an important component of this SMP. Input was received from three public meetings, interviews with residents in the flood prone areas, and city and county officials. In addition to the public meetings, a series of technical working meetings were held with representatives from El Paso County, EPWU, the City of Socorro, the Village of Vinton, and the TWDB.

The County SMP has identified a total of 54 proposed projects totaling \$153,460,000 to address flooding issues throughout the county. Obviously, not all of these projects can be funded at one time so an effort was made to prioritize the projects. In a series of three working meetings, representatives from El Paso County, EPWU, the City of Socorro, the Village of Vinton, and TWDB divided the projects into three categories – Category I (highest), Category II, and Category III. The Category I projects were then further subdivided into high, medium, and low priorities. These prioritizations were not intended to be an absolute ranking of projects, but intended to provide the County and other officials with input for funding considerations for future stormwater projects. A table summarizing the prioritized projects is shown below.

Category	Priority	Number of Projects	Total Cost
I	High	13	\$54,500,000
I	Medium	3	\$12,440,000
I	Low	5	\$46,710,000
II		25	\$26,430,000
III		8	\$13,380,000
Total		54	\$153,460,000

It is important to recognize that these projects are needed to address existing drainage problems based on existing development. It is essential that future developments control stormwater flows so that they do not increase flooding.

A key element of the County SMP was identifying issues that have contributed to stormwater problems throughout the County. One of the overriding problems is that drainage issues often cross jurisdictional boundaries. It is not uncommon for a drainage flow path to begin in an unincorporated part of the County and pass from one city or village into another. Therefore, two to four different entities may be affected by a single flow path. Each of these entities may have its own drainage criteria, development criteria, construction permit requirements, and enforcement standards. If consistent drainage and development policies are not enforced throughout the County, flooding problems will increase. One of the recommendations from this SMP is that countywide stormwater policies be developed to ensure consistent drainage standards, development standards, and construction permits are enforced.

1.0 INTRODUCTION

El Paso County is situated in the Chihuahuan Desert in western Texas. The rainfall averages 8 inches annually, and residents enjoy more than 300 sunny days in a typical year. The County is also subject to occasional hard rains during the summer monsoon season.

Beginning on July 31, 2006 and continuing through early August, a series of torrential rains hit the El Paso area causing flooding in many areas of El Paso and the surrounding communities. This series of rains is referred to as Storm 2006. Following this event, there was a recognition by many involved with the Storm 2006 response that additional data and analysis as well as a longer-term plan of action were required to have the means to address these complex drainage issues in a reasoned and cost-effective manner. Major efforts to address flood issues have since been underway including the completion of the City of El Paso Drainage Design Manual (DDM) (City of El Paso, 2008), and the City of El Paso Stormwater Master Plan (SMP) (hereafter referred to as the City SMP) (URS Corporation [URS] and Moreno Cardenas Inc. [MCi], March 2009). The DDM provides guidance and criteria to protect new development from negatively impacting the flood risk of downstream properties. The City SMP was created to evaluate the existing stormwater drainage system, identify problem areas, and develop a logical approach to upgrade the City's stormwater system.

Following the completion of the City SMP, a similar plan was proposed for selected areas prone to flooding in El Paso County. This plan was funded by the Texas Water Development Board (TWDB), El Paso County, and El Paso Water Utilities (EPWU), with contract administered by EPWU. The selected watersheds in El Paso County are predominantly rural, but are experiencing an increase in development. As development in the County progresses, it will become increasingly important to have a comprehensive stormwater plan to not only address existing flooding issues, but to prevent future flooding issues that could arise from future unregulated development.

2.0 SCOPE OF MASTER PLAN

2.1 Stormwater Master Plan Overview

A SMP was recently completed for the City of El Paso to evaluate the existing stormwater drainage system, identify problem areas, and develop a logical approach to upgrade the City's stormwater system. Following the completion of the City SMP, a similar SMP was proposed for selected watersheds located in the unincorporated areas of El Paso County. The study areas to be included in this master plan were selected based on data provided in the *Study of Rural Homesites Deemed at Risk of Flooding by 100-Year Flood* (El Paso County, 2007). This document identified locations with structures located in the Federal Emergency Management Agency (FEMA) regulatory floodplains. The focus of this SMP is to address specific flood prone areas identified in the above referenced report. These study areas include specific arroyos and flow paths shown on Figure 2-1. For the purposes of this report, they are referred to as:

- Vinton;
- Canutillo;
- Sparks Arroyo and Sub Basin A;
- Socorro;
- Hacienda Real;
- Fabens; and
- Tornillo.

In addition to being identified based on data provided in the *Study of Rural Homesites Deemed at Risk of Flooding by 100-Year Flood* (El Paso County, 2007), the Sparks Arroyo and Sub Basin A Study Area was identified based on information provided in an ongoing feasibility study being performed by the U.S. Army Corps of Engineers (USACE) for the County of El Paso.

Areas deemed at risk due to flooding by the Rio Grande were not evaluated in this SMP. Flooding issues of the Rio Grande fall under the jurisdiction of the International Boundary and Water Commission (IBWC).

The El Paso County SMP (hereafter referred to as the County SMP) was developed to:

- Estimate the stormwater runoff quantities;
- Evaluate major features of the existing stormwater drainage system;
- Identify components of the existing stormwater drainage system that are undersized;
- Estimate sediment loads;
- Recommend major stormwater drainage system improvements;

- Develop a general prioritization of recommended improvements; and
- Recommend countywide stormwater policies.

2.2 Technical Standards and Assumptions Impacting the Plan

The County SMP utilized the same standards and assumptions as the City SMP in order to maintain consistency in project definition and design. It has been prepared to the standards outlined in the City of El Paso DDM. The criteria outlined in the DDM describe standards that are commonly used in the Southwest for evaluating risk and drainage infrastructure design and construction. Drainage structures are typically designed to handle a specific design storm, which is selected based on the desired level of safety and economic risk. The design storm utilized in the DDM is the 24-hour, 100-year storm, also called the 1 percent (%) storm. This is the storm that has a 1% chance of being equaled or exceeded in any given year. While some observers have interpreted this as a once in a lifetime event - and therefore an excessively conservative standard for evaluations and the basis of structural improvements - it is far from either. Rather, the 100-year storm is a statistical description of the probability of the event occurring in any one year based on historical rainfall measurements.

The use of the 100-year design storm is standard in flood evaluations and flood protection. It is the standard used by flood insurance providers, funding entities, and regulators in making many determinations. The County is well served by including the use of this standard in their planning and regulations. To not reflect this standard could be costly to the County on many levels.

Many of the areas studied in this document are currently rural or undeveloped. The analysis and resulting projects outlined in the County SMP are all based on the existing development conditions and do not account for future development. It is assumed that future development will be regulated by the County and local communities so that flood risk will not be increased. This is a very important concept and consistent with standard drainage design practices. However, it is incumbent on the County and communities involved to properly manage future development and enforce development regulations to ensure that these conditions are met.

2.3 Public Meetings and Technical Working Meetings

Throughout the master planning process, a series of three public meetings were held to communicate the planning process, status and results, and to solicit valuable input from the public in order to help focus ongoing analysis efforts (one public meeting has yet to be held as of the Draft SMP submittal). The first public meeting was held in September 2009 to present the proposed study watersheds to be included in the County SMP and to gather input regarding existing flooding issues in these areas. The second public meeting was held in January 2010 to present the preliminary results of the hydrologic and hydraulic analysis and present potential projects to address the flooding issues. The third and final public meeting will be held to present the draft County SMP including the selected project alternatives.

Input from the first two public meetings helped guide the development of the Draft SMP. Input from the third public meeting will be considered in developing the Final SMP.

In addition to the public meetings, a series of working meetings were held with technical representatives from El Paso County, EPWU, TWDB, City of Socorro, and Village of Vinton. During these working meetings, alternatives were discussed and the final projects selected. These working meetings provided an excellent opportunity for the affected stakeholders to collaboratively develop a prioritized list of projects to address drainage issues throughout the County.

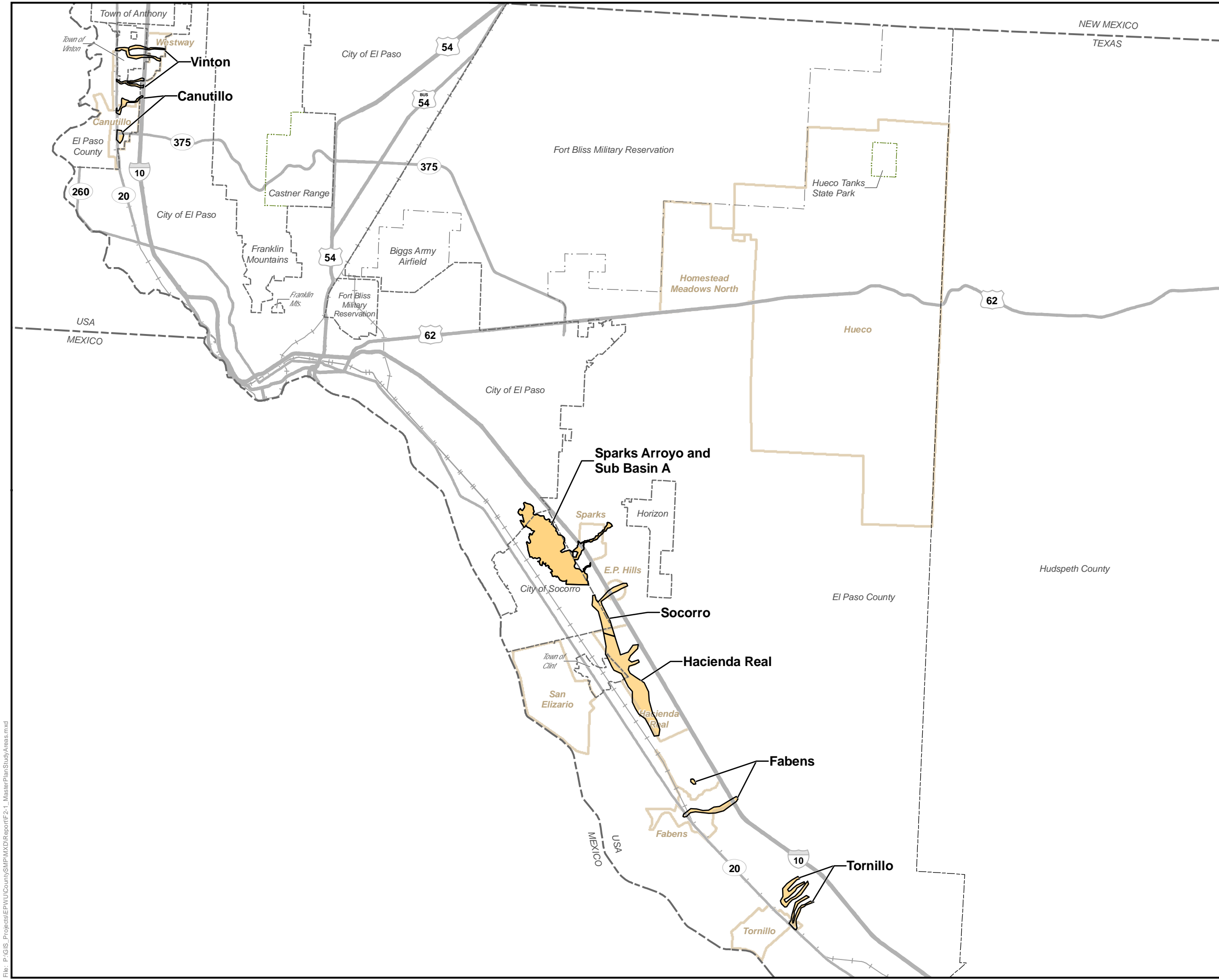

- Legend**
- Study Area
 - Major Road
 - Railroad
 - State Boundary
 - County Boundary
 - Corporate Boundary
 - Military Boundary
 - Park Boundary
 - Designated Place

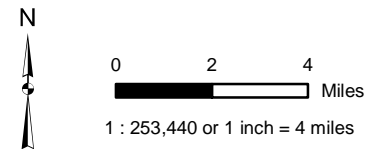

Master Plan Study Areas
El Paso County
Stormwater Master Plan

August 2010 Figure 2-1



File: P:\GIS_P\Projects\EP\U\County\SMP\MXD\Report\F2-1_MasterPlanStudyAreas.mxd

3.0 OVERVIEW OF DRAINAGE SYSTEMS

El Paso County has an arid, warm climate with hot, low-humidity summers and mild, dry winters. Average daily temperatures range from a high of 55 to a low of 33 degrees Fahrenheit (°F) in January and a high of 97°F to a low of 72°F in July. The mean annual precipitation is approximately eight inches with most of it occurring during July through September. Most of the rain in El Paso County consists of afternoon thunderstorms caused by the monsoonal flow from the Gulf of California. These thunderstorms are typically high intensity, short duration, and very limited in affected area.

The Franklin Mountains run from north to south, dividing eastern and western El Paso County, and range approximately 16 miles long and 5 miles wide with a general relief of over 3,000 feet above the surrounding area. The Vinton and Canutillo Study Areas are located in western El Paso County, downstream of the Franklin Mountains. The remaining study areas included in the County SMP (Sparks Arroyo and Sub Basin A, Socorro, Hacienda Real, Fabens, and Tornillo) are located in southeastern El Paso County between an elevated mesa area and the flat Rio Grande Valley. It is at the downstream end of these elevation changes where flooding issues have arisen due to the high volumes of flow combined with erosive soils.

Throughout the County SMP, the seven study areas are discussed in order starting in the northwestern part of the County, proceeding to the southern part of the County:

- Vinton;
- Canutillo;
- Sparks Arroyo and Sub Basin A;
- Socorro;
- Hacienda Real;
- Fabens; and
- Tornillo.

An overview of the limits of the above study areas is shown on Figure 2-1.

3.1 Vinton Study Area

3.1.1 Site Topography

The Vinton Study Area is located on the northwest side of El Paso County, and runs through the Village of Vinton, as shown on Figure 3-1. The drainage features in this area include many natural arroyos and man-made earthen channels.

Many of the contributing watersheds are composed of three different drainage patterns; steep mountainous terrain, alluvial fan, and flat valley area. The flow begins in the steep terrain along the west side of the Franklin Mountains. As the flow approaches the

foothills, the slope of the land begins to flatten resulting in alluvial fans, which consist of less defined channels. As the flow continues downstream, it crosses Interstate Highway 10 (IH-10) through a series of culverts, to either man-made earthen channels or existing natural channels. Before reaching the Rio Grande, flow must be conveyed through a series of culverts under Doniphan Drive.

3.1.2 Site Surficial Geology

The areas within the Franklin Mountains, the foothills, and a portion of the residential areas consist of soils that are classified as hydrologic soil group D per U.S. Department of Agriculture standard classification. These soils are primarily clays at or near the surface causing low infiltration with high runoff potential. The residential areas close to the Rio Grande consist of soils that are classified as hydrologic soil group B. These soils have moderately fine to moderately coarse textures with moderate permeability.

3.1.3 Residential/Commercial Development

Based on field reconnaissance gathered from site visits and the 2008 Orthophotography (El Paso County, 2008), it appears that a majority of the Vinton Study Area has not been developed. There are areas of high density residential development on the lower valley, between the Rio Grande and IH-10. In addition, there are areas of high density residential development east of IH-10, to the north and south of Westway Boulevard.

3.2 Canutillo Study Area

3.2.1 Site Topography

The Canutillo Study Area is located on the northwest side of El Paso County, south of the Village of Vinton, as shown on Figure 3-2. The drainage features in this area include many natural arroyos and man-made earthen channels.

Many of the contributing watersheds for the northern portion of the study area are composed of three different drainage patterns; steep mountainous terrain, alluvial fan, and flat valley area. The flow begins in the steep terrain along the west side of the Franklin Mountains. As the flow approaches the foothills, the slope of the land begins to flatten resulting in alluvial fans, which consist of less defined channels. As the flow continues downstream, it crosses IH-10 through a series of culverts to either man-made earthen channels or existing natural channels. Before reaching the Rio Grande, flow must be conveyed through a series of culverts under Doniphan Drive.

The contributing watershed for the southern portion of the study area is primarily composed of flat valley area. The flow entering the study area accumulates downstream of IH-10 and is conveyed through the watershed via residential streets. The flow enters a topographic depression at the downstream end of the watershed with no outfall to the Rio Grande.

3.2.2 Site Surficial Geology

The Franklin Mountains, the foothills, and a portion of the residential areas consist of soils that are classified as hydrologic soil group D. These soils are primarily clays at or near the surface causing low infiltration with high runoff potential. The residential areas close to the Rio Grande consist of soils that are classified as hydrologic soil group B. These soils have moderately fine to moderately coarse textures with moderate permeability.

3.2.3 Residential/Commercial Development

Based on field reconnaissance gathered from site visits and the 2008 Orthophotography (El Paso County, 2008), it appears that a majority of the Canutillo Study Area has not been developed. There are areas of high density residential and commercial development on the lower valley, between IH-10 and the Rio Grande. Currently, there is no significant development east of IH-10.

3.3 Sparks Arroyo and Sub Basin A Study Area

3.3.1 Site Topography

The Sparks Arroyo and Sub Basin A Study Area, shown on Figure 3-3 is located in southeast El Paso County. The drainage features in the area include several natural arroyos and the Mesa Spur Drain.

The contributing watershed is composed of three different drainage patterns: the mesa at the upstream end, the Sparks Arroyo and Sub Basin A Study Area valley at the downstream end, and the hilly arroyos that connect the mesa and the valley. The upstream mesa has relatively flat slopes of approximately 0.15%. Downstream of the mesa, the terrain becomes steeper (approximately 3%) with several natural arroyos conveying flows to the agricultural valley that is outlined in Figure 3-3 as the Sparks Arroyo and Sub Basin A Study Area. The flows from the arroyos are conveyed beneath IH-10 through a series of culverts before becoming less defined and spreading out to form an alluvial fan as they enter the Sparks Arroyo and Sub Basin A Study Area.

3.3.2 Site Surficial Geology

The mesa, located in the farthest upstream portion of the watershed, is comprised of soils classified as hydrologic soil group C. These soils are typically sandy clay loam. In the hilly arroyo areas separating the mesa and valley, the soil is classified as hydrologic soil group A. These soils have high permeability and are typically sand, loamy sand, or sandy loam. The flat agricultural valley located downstream of the hilly arroyos consists of soils that are classified as hydrologic soil group B. These soils have moderately fine to moderately coarse textures with moderate permeability.

3.3.3 Residential/Commercial Development

Based on field reconnaissance gathered from site visits and the 2008 Orthophotography (El Paso County, 2008), it appears that a large portion of the Sparks and Sub Basin A

Study Area has been developed. There are areas of high density residential development on the upper mesa, upstream of IH-10, and downstream of IH-10 in the central portions of the watershed. In addition, there are areas of high density residential development and commercial development along the western watershed boundary. There is a significant amount of commercial development adjacent to IH-10 and a small amount of residential development just upstream and downstream of the Mesa Spur Drain within the watershed.

3.4 Socorro Study Area

3.4.1 Site Topography

The Socorro Study Area, shown on Figure 3-4, is located in southeast El Paso County and is primarily agricultural in land use. The drainage features in this area include several natural arroyos and the Mesa Spur Drain.

The contributing watershed is composed of three different drainage patterns: the mesa at the upstream end, the Socorro Study Area valley at the downstream end, and the hilly arroyos that connect the mesa and the valley. The upstream mesa has relatively flat slopes of approximately 0.15%. Downstream of the mesa, the terrain becomes steeper (approximately 3%) with several natural arroyos conveying flows to the agricultural valley that is outlined in Figure 3-4 as the Socorro Study Area. The flows from the arroyos are conveyed beneath IH-10 through a series of culverts before becoming less defined and spreading out to form an alluvial fan as they enter the lower elevations of the Socorro Study Area. The Socorro Study Area is bound on the downstream edge by the Mesa Spur Drain.

3.4.2 Site Surficial Geology

The mesa, located in the farthest upstream portion of the watershed, is comprised of soils classified as hydrologic soil group C. These soils are typically sandy clay loam. In the hilly arroyo areas separating the mesa and valley, the soil is classified as hydrologic soil group A. These soils have high permeability and are typically sand, loamy sand, or sandy loam. The flat agricultural valley located downstream of the hilly arroyos consists of soils that are classified as hydrologic soil group B. These soils have moderately fine to moderately coarse textures with moderate permeability.

3.4.3 Residential/Commercial Development

Based on field reconnaissance gathered from site visits and the 2008 Orthophotography (El Paso County, 2008), it appears that a majority of the Socorro Study Area has not been developed. There are areas of high density residential development on the upper mesa and upstream of IH-10 in the western portions of the watershed. In addition to these areas, there is a small amount of commercial development adjacent to IH-10 and a small amount of residential development just upstream and downstream of the Mesa Spur Drain within the watershed.

3.5 Hacienda Real Study Area

3.5.1 Site Topography

The Hacienda Real Study Area, shown on Figure 3-5, is located in southeast El Paso County and is primarily agricultural in land use. The drainage features in this area include several natural arroyos, as well as the Mesa Drain, and Salatral Lateral.

The contributing watershed is composed of three different drainage patterns: the mesa at the upstream end, the Hacienda Real Study Area valley at the downstream end, and the hilly arroyos that connect the mesa and the valley. The upstream mesa has relatively flat slopes of approximately 0.1%. Downstream of the mesa, the terrain becomes steeper (approximately 3%) with several natural arroyos conveying flows to the agricultural valley that is outlined in Figure 3-5 as the Hacienda Real Study Area. The flows from the arroyos are conveyed beneath IH-10 through a series of culverts before becoming less defined and spreading out to form an alluvial fan as they enter the lower elevations of the Hacienda Real Study Area. The Hacienda Real Study Area is bound on the downstream edge by the Mesa Drain and the elevated Salatral Lateral. Site inspection revealed that the Salatral Lateral presents a continuous boundary with no identified crossings or openings that would allow upstream flows to cross.

3.5.2 Site Surficial Geology

The mesa, located in the farthest upstream portion of the watershed, is comprised of soils classified as hydrologic soil group C. These soils are typically sandy clay loam. In the hilly arroyo areas separating the mesa and valley, the soil is classified as hydrologic soil group A. These soils have high permeability and are typically sand, loamy sand, or sandy loam. The flat agricultural valley located downstream of the hilly arroyos consists of soils that are classified as hydrologic soil group B. These soils have moderately fine to moderately coarse textures with moderate permeability.

3.5.3 Residential/Commercial Development

Based on field reconnaissance gathered from site visits and the 2008 Orthophotography (El Paso County, 2008), it appears that a majority of the Hacienda Real Study Area has not been developed. There is an area of high density residential development on the upper mesa in the western portion of the watershed and some areas of low density development on the upper mesa in the central portion of the watershed. In addition to these areas, there is a small amount of residential development just upstream and downstream of the Northloop Drive within the watershed.

3.6 Fabens Study Area

3.6.1 Site Topography

The Fabens Study Area is located in southeast El Paso County, and runs through the Fabens community, as shown on Figure 3-6. The area is mostly undeveloped, although the Fabens community is composed of agricultural and residential lands. The drainage

features include natural channels, the San Felipe Arroyo, the Salatral Lateral, the River Drain, and the Fabens Dam.

The contributing watersheds are composed of many different drainage patterns. The upstream ends of the watersheds begin in the mesa, a relatively flat area, with a slope of approximately 0.1%. The downstream end, known as the lower valley, is also a relatively flat area where the community of Fabens is located along with many of the agricultural lands. Between these two flat areas lies the escarpment area, which is composed of many natural well-defined channels with steeper slopes. Several earthen dams have been constructed within the watershed in an attempt to control flow as it travels downstream. The flow is conveyed through a series of culverts under IH-10 and continues to flow downstream through either natural channels or man-made earthen channels. There are only a few openings along the intricate system of canals and irrigation ditches within the lower valley that allow stormwater to flow and exit the system.

3.6.2 Site Surficial Geology

The upstream watershed is composed of soils classified as hydrologic soil group C. These soils are typically sandy clay loams. As the watersheds enter into the steeper more defined channel area, the soil is classified as hydrologic soil group A. These soils have high permeability and are typically sand, loamy sand, or sandy loam. In the downstream area, which is made up of agricultural and residential lands, the soil is classified as hydrologic soil group B. These soils have moderate permeability and have moderately fine to moderately coarse textures.

3.6.3 Residential/Commercial Development

Based on field reconnaissance gathered from site visits and the 2008 Orthophotography (El Paso County, 2008), it appears that the majority of the Fabens Study Area has not been developed. There is an area of high density residential development within the town of Fabens near the downstream portion of the San Felipe Arroyo. There is no other significant development within this study area.

3.7 Tornillo Study Area

3.7.1 Site Topography

The Tornillo Study Area, shown on Figure 3-7, is located in southeast El Paso County and runs through the town of Tornillo. The drainage features in this area are natural channels.

The contributing watershed is composed of hilly arroyos with a relatively constant slope of approximately 2%. Flows crossing IH-10 are conveyed through a series of culverts as they continue downstream through natural channels. As the flow reaches the residential areas, the channels become less defined and the flow begins to disperse, traveling along the path of least resistance.

3.7.2 Site Surficial Geology

The upstream watershed is composed of soils classified as hydrologic soil group C. These soils are typically sandy clay loams. The majority of the watersheds are located in an area where the soil is classified as hydrologic soil group A. These soils have high permeability and are typically sand, loamy sand, or sandy loam.

3.7.3 Residential/Commercial Development

Based on field reconnaissance gathered from site visits and the 2008 Orthophotography (El Paso County, 2008), it appears that a majority of the Tornillo Study Area has not been developed. There is a small area of low density residential development in the lower portions of the watershed, along the southern boundary. In addition to this area, there is a very small amount of commercial development in the central portion of the watershed. In addition to the currently developed areas, a new port of entry is expected to be built in the near future. The new port of entry will result in a roadway that connects IH-10 to the US/Mexico border. The roadway is expected to cross the northernmost channel, along with the two channels located directly south. The channels in this area, which are currently unnamed, will be known from north to south in this study as High School Channel, South High School Channel, and Flow Path T.

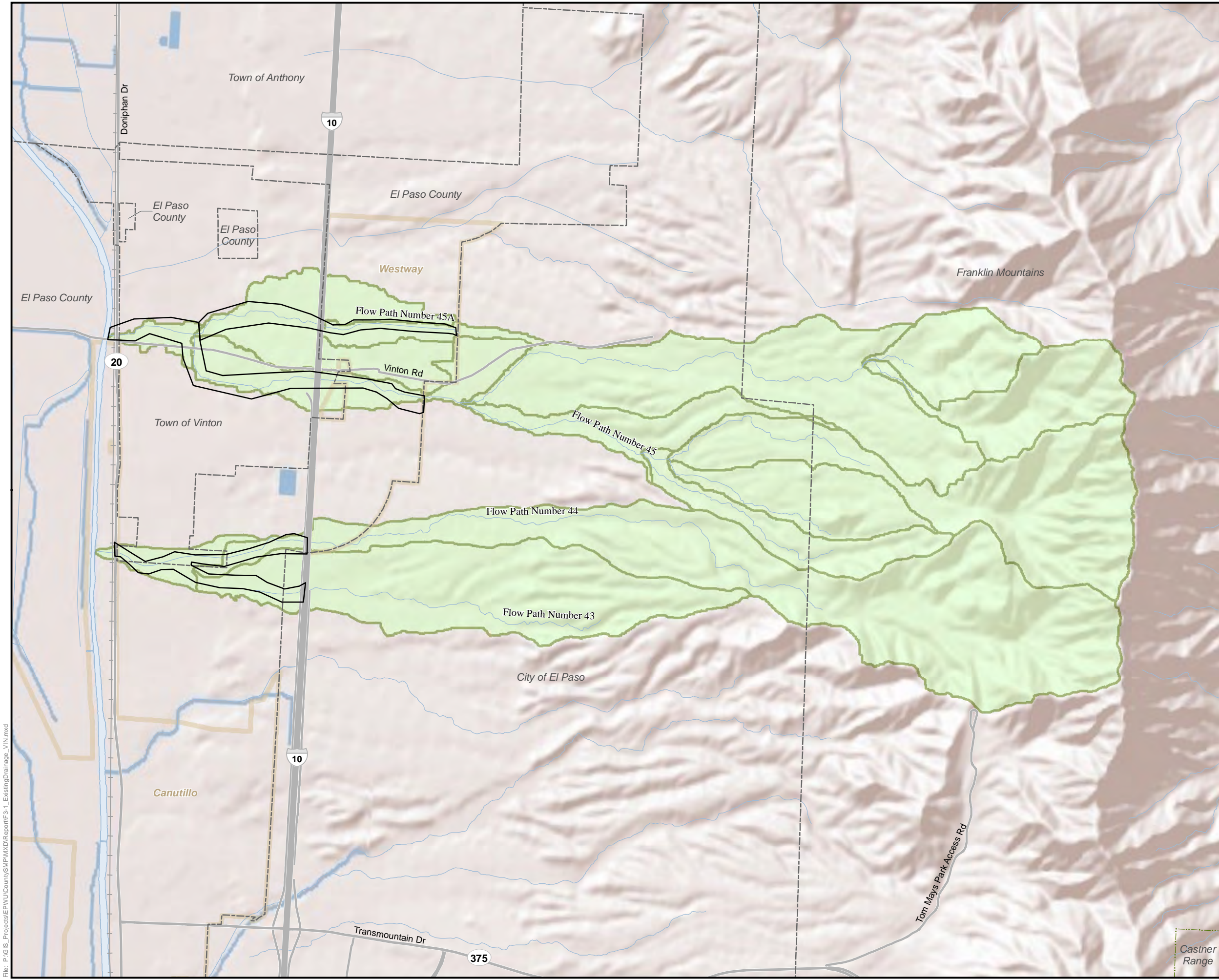

- Legend**
- Watershed
 - Study Area
 - Major Road
 - Railroad
 - Streamline
 - Water Body
 - Corporate Boundary
 - Designated Place

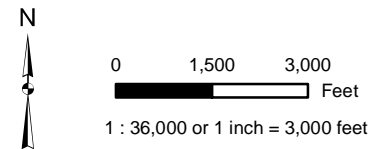

Vinton Study Area
El Paso County
Stormwater Master Plan

August 2010 Figure 3-1



File: P:\GIS_Projects\EP\U\CountySMP\MXD\Report\F3-1_ExistingDrainage_VIN.mxd

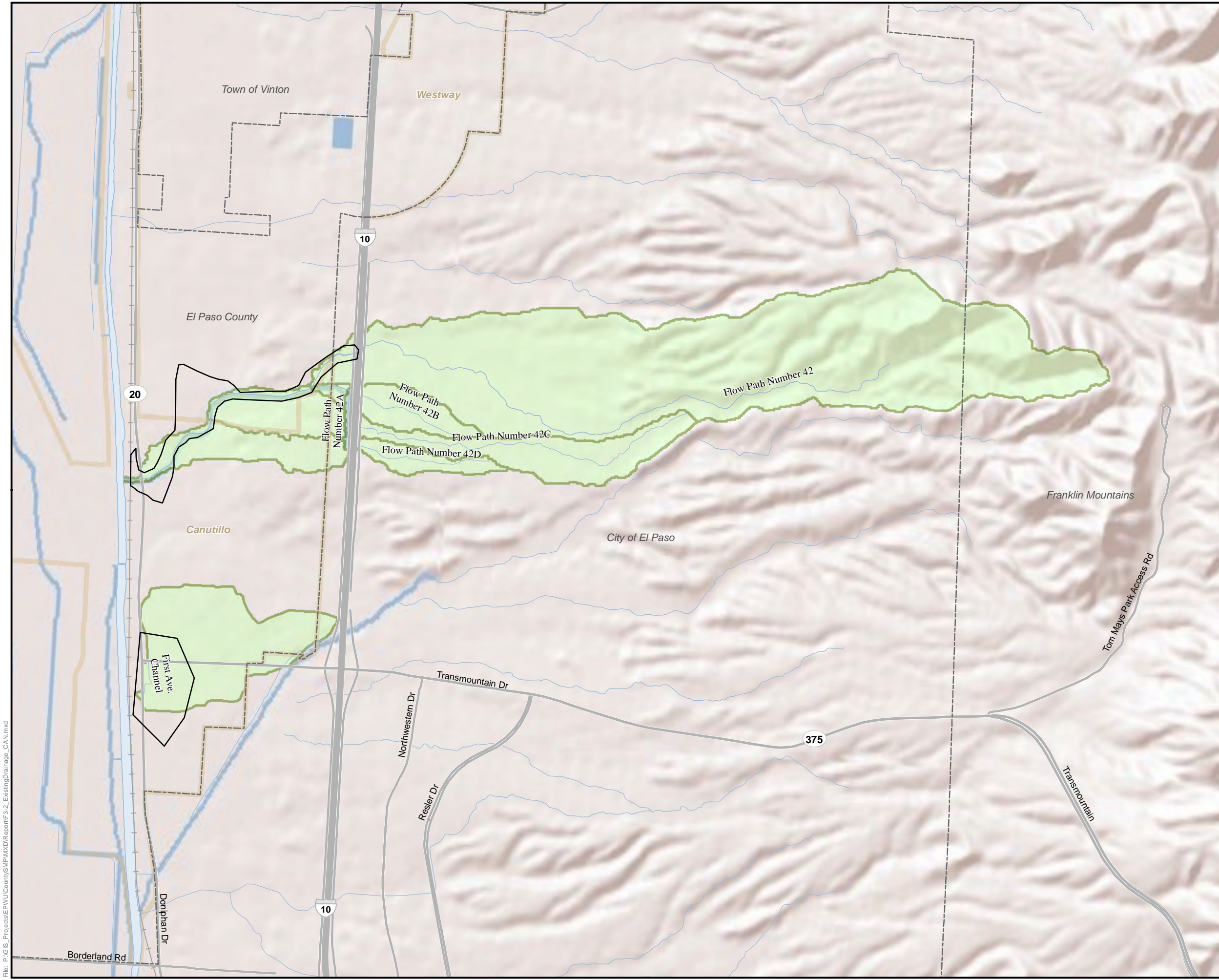

- Legend**
- Watershed
 - Study Area
 - Major Road
 - Railroad
 - Streamline
 - Water Body
 - Corporate Boundary
 - Designated Place

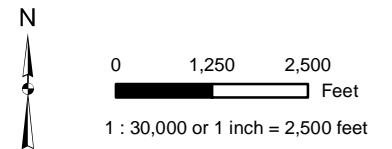

Canutillo Study Area
 El Paso County
 Stormwater Master Plan

August 2010 Figure 3-2



File: P:\GIS_Projects\EP\U\County\SMP\MXD\Report\F3-2_ExistingDrainage_CAN.mxd

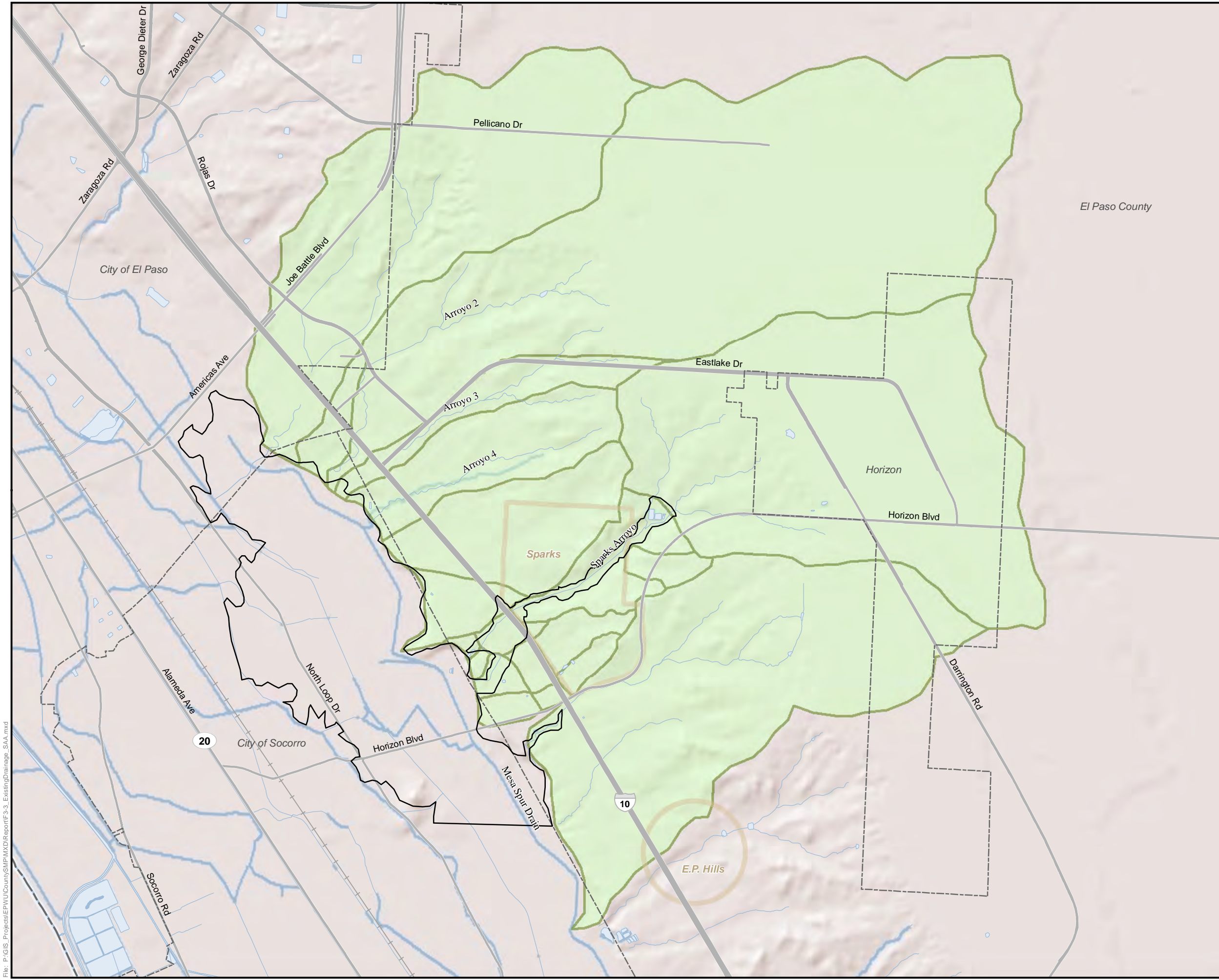

- Legend**
- Watershed
(Digitized from USACE Figure)
 - Study Area
 - Major Road
 - Railroad
 - Streamline
 - Water Body
 - Corporate Boundary
 - Designated Place

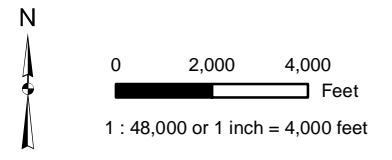

**Sparks Arroyo and
Sub Basin A Study Area**
El Paso County
Stormwater Master Plan

August 2010 Figure 3-3



File: P:\GIS_Projects\EP\CountySMP\MXD\Report\F3-3_ExistingDrainage_SAA.mxd

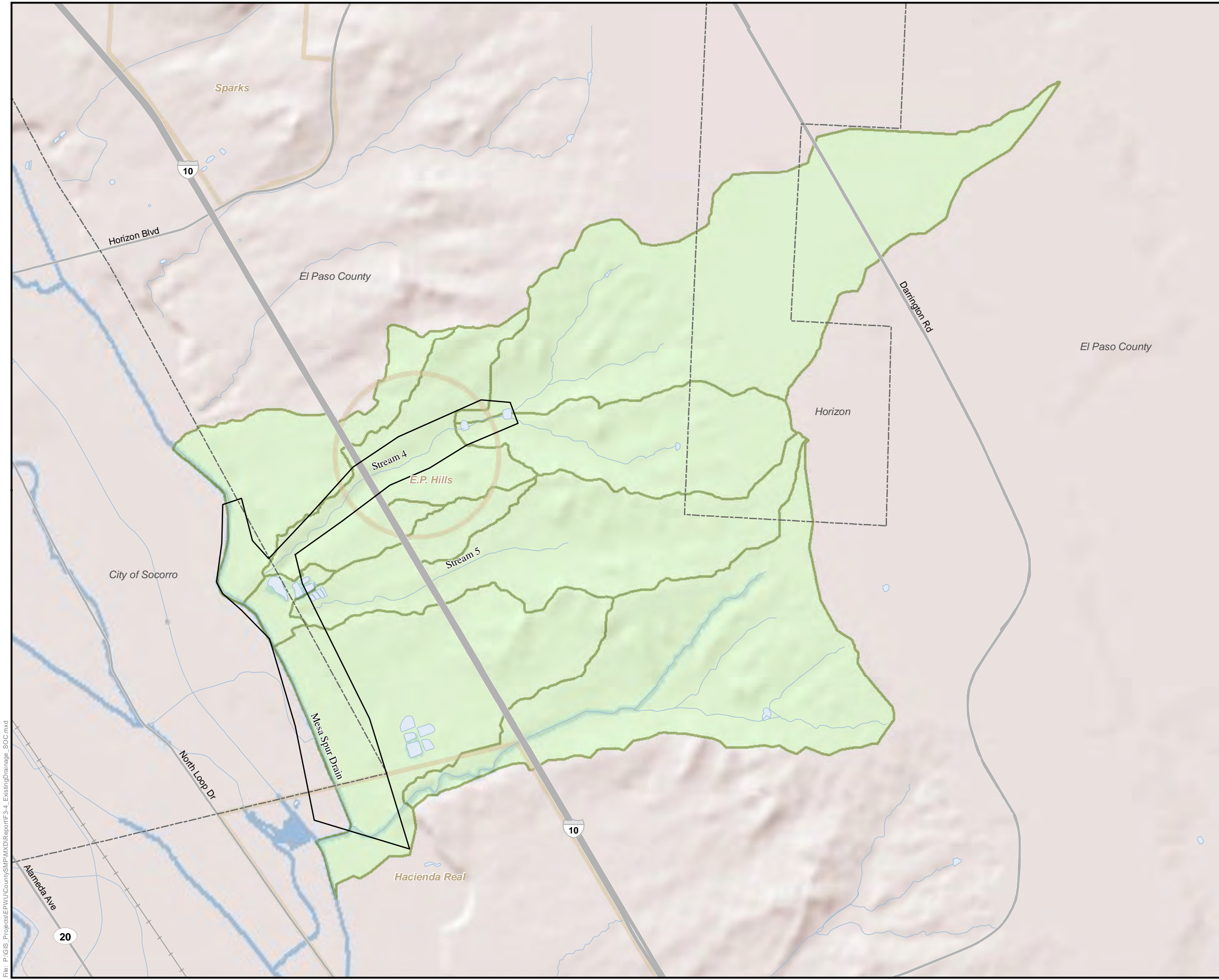

- Legend**
- Watershed
 - Study Area
 - Major Road
 - Railroad
 - Streamline
 - Water Body
 - Corporate Boundary
 - Designated Place

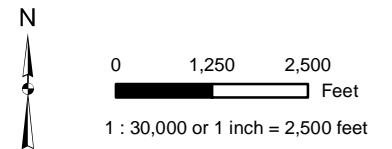

Socorro Study Area
 El Paso County
 Stormwater Master Plan

August 2010 Figure 3-4



File: P:\GIS_Projects\EP\U\County\SMP\MXD\Report\F3-4_ExistingDrainage_SOC.mxd

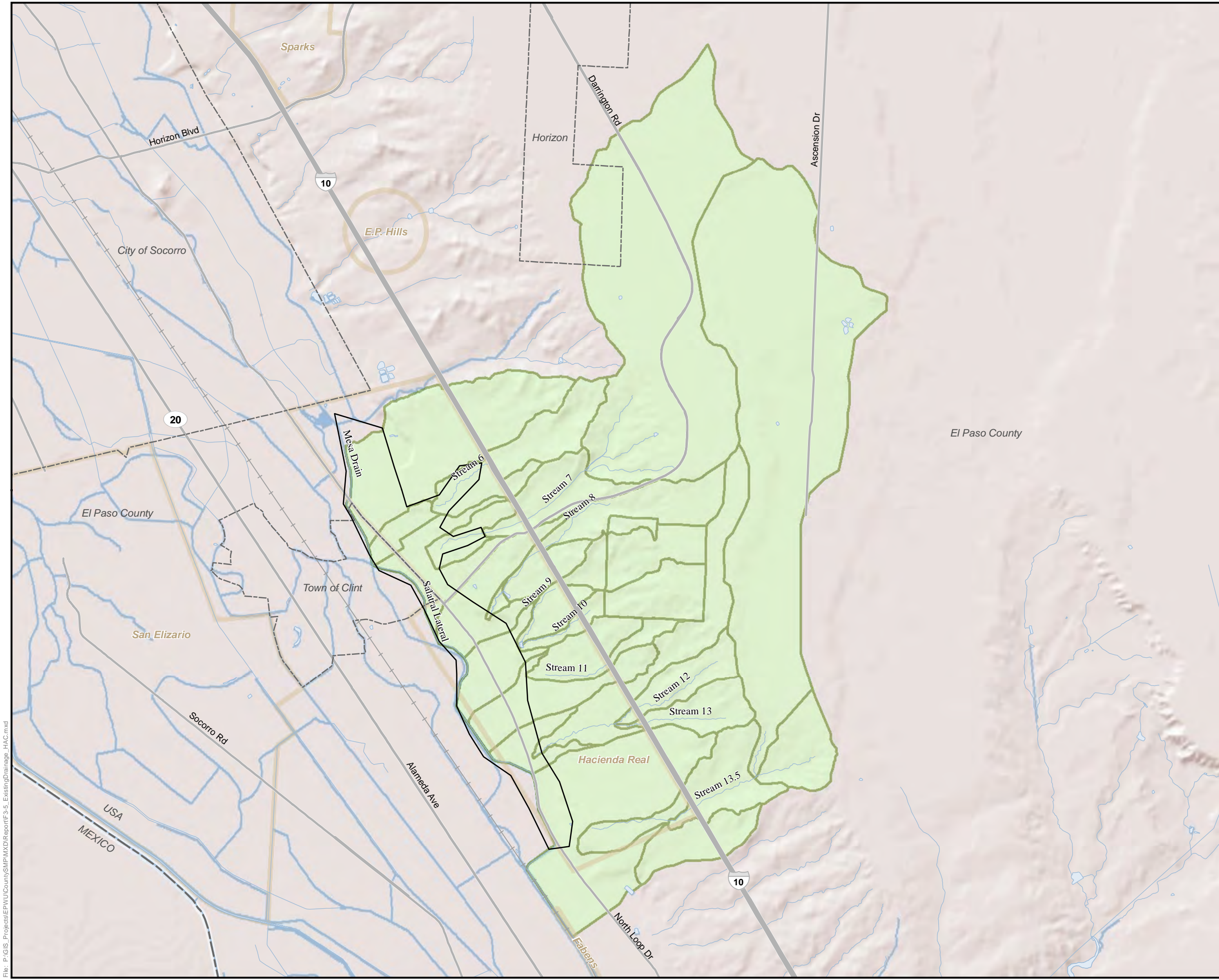

- Legend**
- Watershed
 - Study Area
 - Major Road
 - Railroad
 - Streamline
 - Water Body
 - State Boundary
 - Corporate Boundary
 - Designated Place

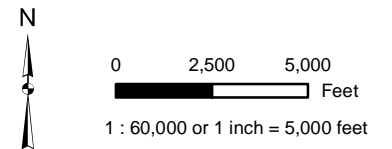

Hacienda Real Study Area
 El Paso County
 Stormwater Master Plan

August 2010 Figure 3-5



File: P:\GIS_Projects\EP\U\County\SMP\MXD\Report\F3-5_ExistingDrainage_HAC.mxd

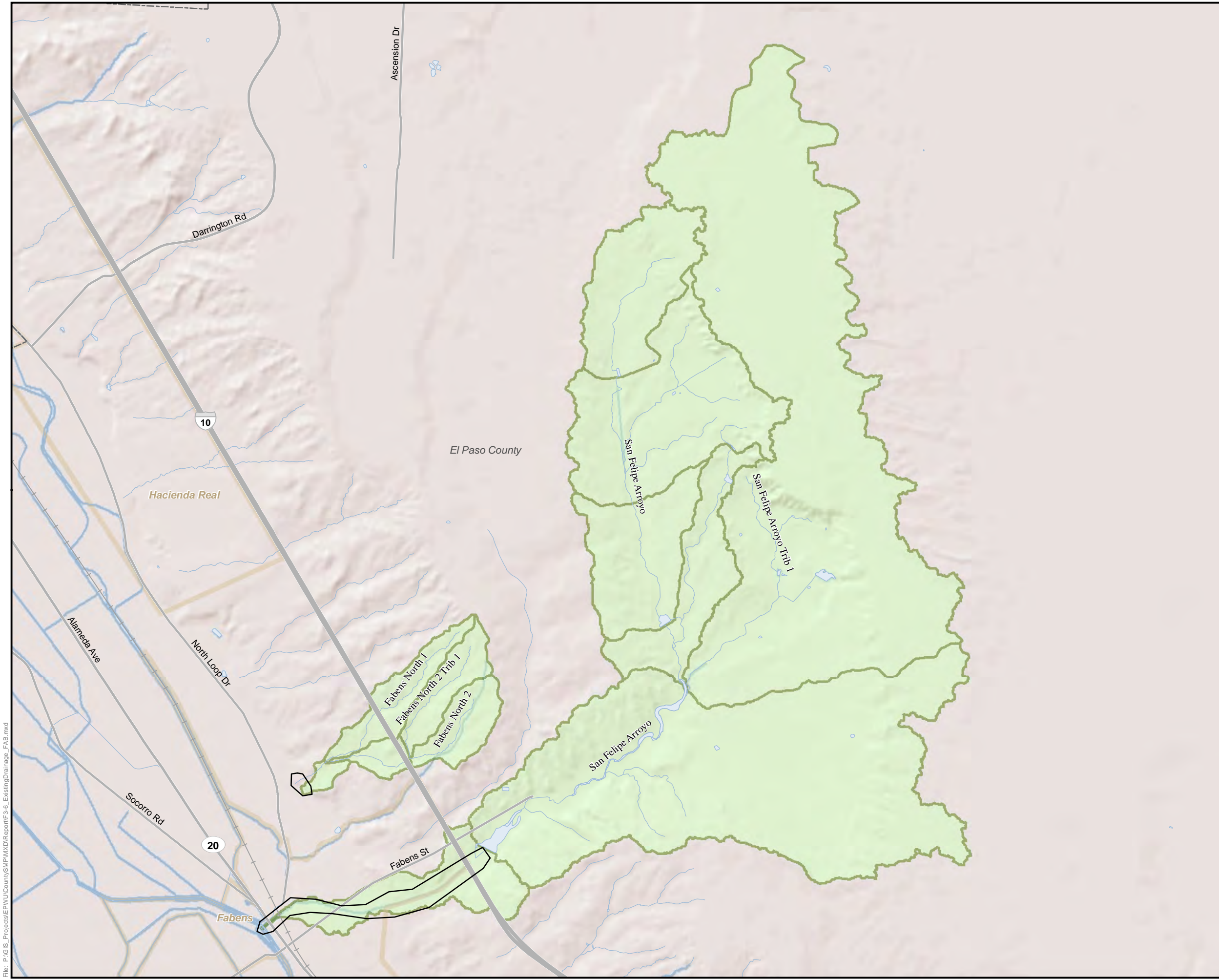

- Legend**
- Watershed
 - Study Area
 - Major Road
 - Railroad
 - Streamline
 - Water Body
 - Corporate Boundary
 - Designated Place

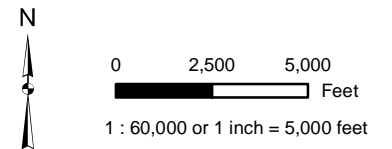

Fabens Study Area
 El Paso County
 Stormwater Master Plan

August 2010 Figure 3-6



File: P:\GIS_Projects\EP\UUCounty\SMP\MXD\Report\F3-6_ExistingDrainage_FAB.mxd

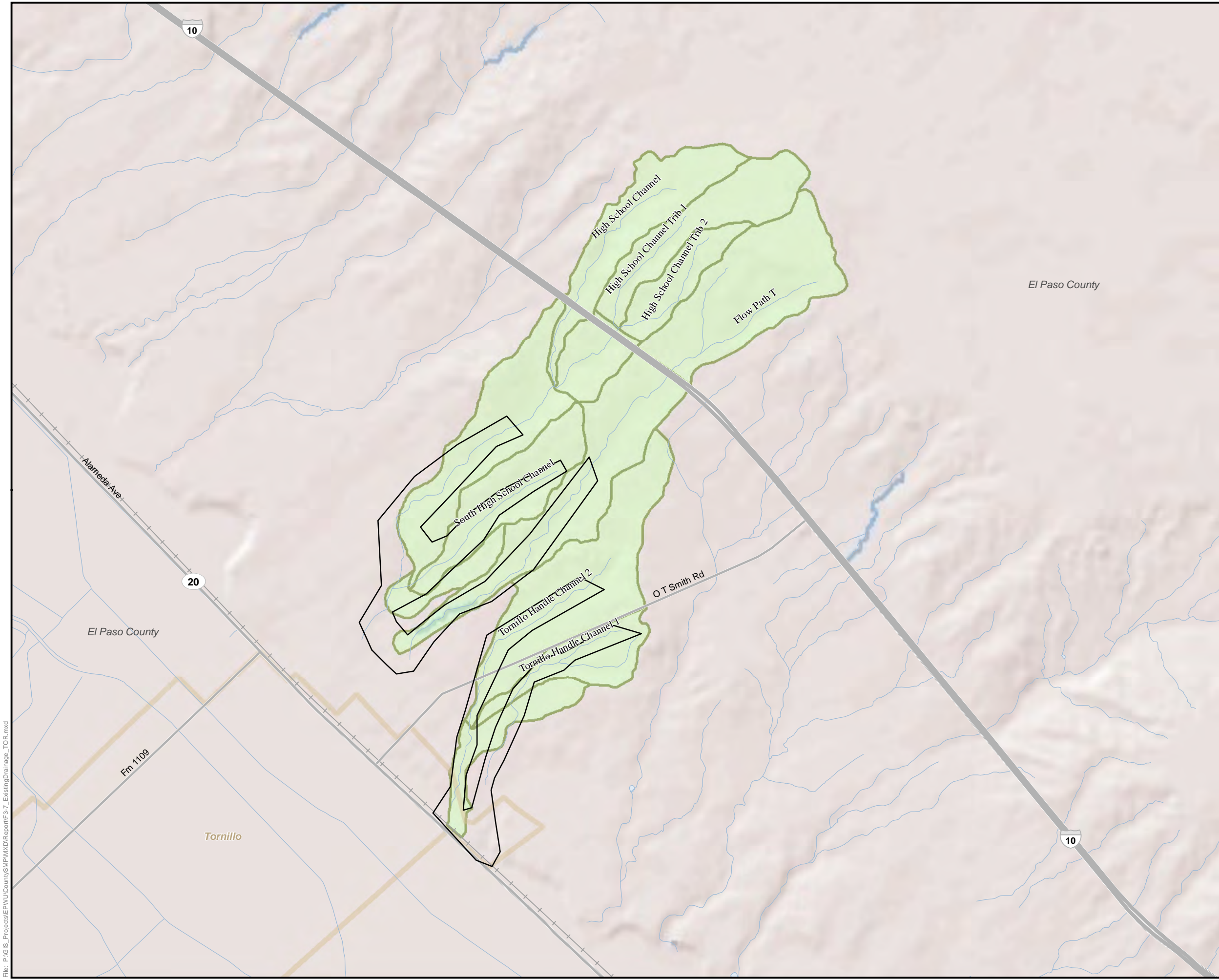

- Legend**
- Watershed
 - Study Area
 - Major Road
 - Railroad
 - Streamline
 - Water Body
 - Corporate Boundary
 - Designated Place

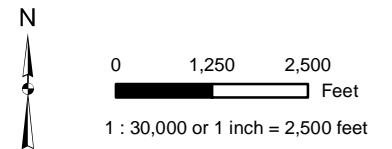

Tornillo Study Area
 El Paso County
 Stormwater Master Plan

August 2010 Figure 3-7



File: P:\GIS_Projects\EP\U\County\SMP\MXD\Report\F3-7_ExistingDrainage_TOR.mxd

4.0 MASTER PLAN METHODOLOGY

Several areas of El Paso County experience flooding problems on an annual basis. Other areas experience flooding only during significant rainfall events. The study areas included in this master plan were selected based on the data provided in the *Study of Rural Homesites Deemed at Risk of Flooding by 100-Year Flood* (El Paso County, 2007). This document provides mapping of regulatory FEMA floodplains and identifies structures that currently lie within these floodplains. Areas with a significant number of structures shown to be at risk of flooding by the 100-year flood were selected as the initial study areas for this plan. Based on initial meetings with the County as well as site visits, a more specific list of problem areas was created.

Watershed delineations were generated for these problem areas based on available topographic information. The watershed boundaries were used in the hydrologic analysis, which led to the analysis of the 100-year storm. The peak discharge rates were developed for the existing development conditions found within the County at the time of this analysis.

Based on the hydrologic analysis, the existing drainage system was evaluated for conveyance capacities. These capacities were based on data gathered from a variety of sources. Hydrologic and hydraulic evaluations were performed in accordance with the City of El Paso DDM.

In general, the approach to evaluating the identified El Paso County Study Areas' existing drainage system included the following steps:

- Review the existing data available to be used in this study, including existing studies and plans;
- Divide the major watersheds developed from earlier studies into sub-watersheds at identified problem areas, as well as any major crossings or other significant drainage features;
- Determine the watershed hydrologic properties;
- Supplement available data with field reconnaissance;
- Determine the geometric properties of the drainage features from available data;
- Develop the hydrologic modeling in order to estimate peak discharge rates and volumes;
- Evaluate the existing system conveyance capacities;
- Identify system inadequacies;
- Develop conceptual alternatives to improve system performance and minimize potential flooding and flood damages;
- Evaluate the conceptual alternatives; and
- Select the preferred alternative.

The Sparks Arroyo and Sub Basin A Study Area is being analyzed as part of an ongoing USACE feasibility study. For this study area, information from the USACE analysis was used where available. The following steps were involved in the evaluation of the Sparks Arroyo and Sub Basin A Study Area:

- Review data provided by the USACE relating to the analysis of the study area;
- Review data provided by the USACE related to the recommended improvements;
- Perform approximate hydrologic and hydraulic analysis to generate additional data required to develop and evaluate improvements per the methods used in this County SMP; and
- Develop and evaluate improvements per the methods used in this County SMP.

The County SMP did not include validation of regulatory FEMA floodplains or formal delineation of new floodplains in currently unmapped areas of the County. This study is a planning document and does not guarantee that identified solutions without further detailed definition will lead to removal of flood prone areas from designated floodplains or flood zones.

4.1 Review of Historical Flooding and Prior/Ongoing Studies

URS used multiple data sources to determine where historical flooding problems occurred and to identify potential solutions. Valuable input and information was received from:

- El Paso County Staff;
- EPWU Staff;
- Public during Public Meeting Number (No.) 1;
- Local Residents during field visits;
- Mayor of Socorro;
- City Manager from Socorro;
- Representatives from Vinton;
- Public during Public Meeting No. 2; and
- USACE.

This information was compiled at the onset of the project and was continually evaluated and updated throughout the master planning process. In addition, URS received the following specific information:

Report	Date	Author	Description
Interviews with El Paso County	2009	URS	Interviews were conducted with engineering and maintenance personnel to help in identifying problem areas, the causes of the problems, and possible solutions.
Interview with Matt Dyer from Parker, Smith, & Cooper, Inc. (PSC) to discuss Clint Landfill drainage scenario	2009	PSC	PSC provided an exhibit with watershed delineations, as well as retention pond locations and storage volumes.
Interview with Halff Associates to discuss ongoing Clint Landfill analysis	2009	Halff Associates	Halff Associates discussed the status of an ongoing analysis of the Clint Landfill area. The study completion date was behind the schedule for the production of this County SMP.
Study of Rural Homesites Deemed at Risk of Flooding by 100-Year Flood	2007	El Paso County	This report details areas of El Paso County with structures shown to be at risk by the 100-year FEMA Regulatory Floodplain.
Sparks Arroyo Flood Control Project	2004 - Present	USACE	This draft feasibility study and other associated documents provided by the USACE identify problem areas within the Sparks Arroyo and Sub Basin A Study Area, provide limited draft information on the hydrologic analysis performed, provide draft potential improvements as solutions to the identified problems, and provide draft estimated costs for each of the improvements.

4.1.1 Vinton Study Area

As part of the City SMP, Flow Path Number 45 and Flow Path Number 45A were studied and improvements were recommended. The information and recommendations put forth within the City SMP were incorporated into the County SMP.

4.1.2 Canutillo Study Area

The IBWC conducted a study called, *Development of Alternatives for Canutillo Flood Control Improvements, Rio Grande Canalization Project* in February 2007. The purpose of the analysis was to provide flood control improvement alternatives along the Rio Grande for the town of Canutillo. URS evaluated the alternatives and determined that many of the alternatives involved improving the levee along the Rio Grande. Alternatives to improve the levee were not considered within the purview of the County and not included in this study.

FEMA conducted an update of the Flood Insurance Rate Maps (FIRMs) and Flood Insurance Study (FIS) for El Paso County in 2005. Since that time, a Letter of Map Revision (LOMR) has been approved for the portion of Flow Path Number 42 that runs

through Canutillo Heights and a Conditional Letter of Map Revision (CLOMR) has been approved for the portion from Los Mochis to IH-10. The hydrologic and hydraulic analyses that were completed as part of these revisions utilized the Hydrologic Engineering Center-Hydrologic Modeling System (HEC-HMS) and the Hydrologic Engineering Center-River Analysis System (HEC-RAS), respectively. URS obtained the hydrologic and hydraulic analyses, as they are applicable to portions of the Canutillo Study Area. The revised hydrologic analysis results were incorporated into the hydraulic model and the channel was analyzed accordingly.

4.1.3 Sparks Arroyo and Sub Basin A Study Area

The USACE is currently conducting an ongoing feasibility study for the Sparks Arroyo and Sub Basin A Study Area. The study consists of a discussion of problem areas, a hydrologic analysis for the watersheds contributing to these problem areas, development of potential improvements, and conceptual design and costing of the improvements. URS coordinated with the USACE to obtain as much information as possible from this study and utilized the information to develop potential improvements using a method consistent with what was done for the rest of the County SMP. The developed improvements are similar to, but in some cases with substantial differences to, the USACE improvements. These projects were included in the County SMP and evaluated with the other projects developed by URS.

Villaverde Engineering, under contract to the City of Socorro, is currently performing designs for improvement of the Stockyard Drive Channel to reduce flooding conditions in that vicinity. This improvement is considered an interim measure to improve conditions prior to the more complete solutions recommended in this study.

4.1.4 Socorro Study Area

URS is unaware of any ongoing or prior drainage studies relating to the Socorro Study Area.

4.1.5 Hacienda Real Study Area

Halff Associates is currently conducting hydrologic and hydraulic analysis of the arroyos in the vicinity of the City of El Paso Clint Landfill. URS contacted Halff Associates to determine if any of the studies they are currently completing will be beneficial to the analysis that URS is scoped to perform. Per initial discussions, analysis and data from this project would not be available within a time frame that would allow for incorporation into this SMP. URS proceeded with watershed delineations based on the best available data which included 2004 Topography (Texas Department of Transportation [TxDOT], 2004).

In addition to the Halff analysis, Parkhill, Smith & Cooper Inc. (PSC) analyzed several of the ponds located on the Clint Landfill property. For these ponds, PSC was able to provide URS with valuable information regarding watershed delineations and run-off detention design. The watershed delineations and storage volumes provided by PSC were incorporated into the hydrologic analysis for the Hacienda Real Study Area.

4.1.6 Fabens Study Area

FEMA conducted an update of the FIRMs and FIS for El Paso County in 2005. As part of this update, a hydrologic and hydraulic analysis was conducted on the San Felipe Arroyo. URS determined that the FEMA hydrologic analysis did not include the dams within the upper reaches of the San Felipe Arroyo Watershed and that it would not be applicable to this SMP. The hydraulic analysis, conducted using HEC-RAS, was determined to be applicable, and was modified to reflect the revised hydrologic analysis findings.

4.1.7 Tornillo Study Area

URS is unaware of any ongoing or prior drainage studies relating to the Tornillo Study Area.

4.2 Hydrology

The purpose of the hydrologic analysis was to estimate peak discharge rates that were used to evaluate capacities of the existing facilities as well as size proposed facilities. In general, the hydrologic analysis performed as part of this SMP utilized the Unit Hydrograph Method as outlined in the DDM. Detailed information regarding the hydrologic analysis and the results of the analysis can be found in Appendix A.

Hydrologic analysis for the Sparks Arroyo and Sub Basin A Study Area was performed by the USACE as part of an ongoing feasibility study. URS used data from the USACE hydrologic analysis to develop projects in this study area.

4.3 Hydraulics

The purposes of the hydraulic analysis were to evaluate capacities of existing structures and to size proposed structures. The level of detail available for characterizing hydraulic capacity of existing structures varied across the County, from areas where a FEMA detailed study had been previously performed (with associated surveyed cross-sections and structures) to areas where structural dimensions and elevations were estimated by field measurements. The hydraulic designs of proposed structures were dependent upon the level of detail of the available information, but are consistent with the planning level of this County SMP. Detailed information regarding the hydraulic analyses inputs, methods, and results can be found in Appendix B.

4.4 Working Meetings

Throughout the master planning process, technical input was received from El Paso County, EPWU, and key stakeholders during a series of four working meetings. The working meetings included the following stakeholders:

- El Paso County;
- EPWU;
- The City of Socorro;

- The Village of Vinton; and
- TWDB.

The initial working meeting included a discussion of the selected study areas and the technical approach for the stormwater master planning process. County personnel helped to identify critical flooding features located in each study area, and accompanied URS staff on field visits to each study area. The second working meeting was held after initial modeling results were completed and focused on discussion of identified problems, potential projects, and the path forward.

The third and fourth working meetings included stakeholders listed above and focused on detailed discussions of proposed project alternatives, including selection of alternatives and prioritization of projects.

4.5 Problem Area Definitions

Problem areas were defined within each study area based on information provided by the County, information gathered at the first public meeting, field reconnaissance, and the hydrologic and hydraulic analysis performed as part of this SMP, and information from previous studies. Areas currently experiencing flooding and areas at risk for potential flooding were identified as problem areas. In some cases, multiple flooding issues were combined into a single problem area. The problem areas identified were discussed during the second working meeting and agreed upon by the parties present.

4.6 Development of Project Alternatives

For each problem area defined, multiple alternatives were identified to address the issues associated with the problem area. However, for problem areas with a clear solution only one alternative was carried forward. These alternatives were developed with input from the County. Each project alternative consisted of proposed improvements designed to meet the 100-year storm criteria whenever possible. Improvements considered include:

- Adding or improving detention/retention;
- Adding sediment and or debris control;
- Improving channel and crossing capacity; and
- Building new channels and storm drains.

Each developed alternative consisted of a series of individual improvements. Sizing of the improvements was based on the hydrologic and hydraulic analyses performed as part of this County SMP. Cost estimates for each alternative were developed. Cost estimates included the costs associated with the structure improvements as well as excavation and grading, demolition, possible utility relocations, right-of-way (ROW) acquisitions, and repaving as applicable. The costs developed for each improvement were then summed to develop a total project cost. The total project cost was then used for evaluation of each alternative. The methodologies used for concept design and cost estimation of alternatives are described in Appendix C.

Some potential projects within the Vinton Study Area were developed recently by URS as part of the City SMP, and at the request of the County and EPWU, were incorporated into the County SMP. The concept designs and cost estimates developed as part of the City SMP for these projects were incorporated into this SMP without modification.

Additionally, a number of potential projects in the Sparks Arroyo and Sub Basin A Study Area were identified as part of an ongoing feasibility study performed by the USACE. The project locations and general concepts incorporated into this SMP are consistent with the ongoing USACE feasibility study, but the conceptual designs and cost estimates do not reflect USACE designs. The conceptual designs and cost estimates for these projects were developed using methods consistent with design criteria used for the rest of the County SMP.

4.7 Alternatives Evaluation

Table C-6 in Appendix C provides a listing of each alternative and its associated estimated construction cost. Tables C-2 through C-5 list the principal improvement components of each alternative.

4.8 Alternatives Selection

Working Meeting No. 3 was held to review and discuss the various alternatives for each project. The meeting included representatives from El Paso County, the City of Socorro, the Village of Vinton, and EPWU. URS presented the various options and provided technical input to the meeting participants. Representatives from TWDB attended the meeting as observers. During the meeting the attendees:

- Discussed the basic issue to be addressed by each project;
- Discussed each alternative for a project; specifically, type of improvement, cost, location, and level of flood protection;
- Discussed the technical and qualitative factors for each alternative; and
- Selected the most favorable alternative for each project.

4.9 Prioritization

During working meetings three and four, the stakeholders identified in Section 4.8 developed general prioritization criteria and then evaluated the recommended projects based on those criteria. The end result was a prioritized list of projects that will help identify the relative priority for funding the various projects.

5.0 IDENTIFIED PROBLEM AREAS

Initial phases of the stormwater master planning process included:

- Hydrologic and hydraulic analyses for each of the study areas;
- Field reconnaissance of the study areas;
- Review of previous studies;
- Discussions with local residents; and
- Discussions with representatives from El Paso County, EPWU, TWDB, City of Socorro, and the Village of Vinton.

These activities resulted in identifying specific problem areas within each of the study areas. The problem areas are identified with three numbers representing the study area and numbered sequentially. For example, the specific problem areas discussed in this study for Vinton are identified as VIN1, VIN2, VIN3, etc. The following sections provide a general description of the problems identified in each study area followed by more detailed description of each identified problem area.

5.1 Vinton Study Area

A number of flooding and sedimentation issues were identified in the Vinton Study Area based on information gathered from representatives from El Paso County, Village of Vinton, field reconnaissance gathered from site visits, and previous studies. Flooding of residences and property located along the arroyos is the primary concern in this area.

Many of the upstream watersheds for the Vinton Study Area are very large, causing a significant amount of uncontrolled water and sediment to be carried to downstream residential areas via natural arroyos. As the large flows reach the residential areas, the arroyos become constricted, resulting in the flooding of homes and properties.

As identified in the City SMP, there are a number of identified issues associated with Flow Path Number 45 and its tributary Flow Path Number 45A. In addition to many portions of the channels not having sufficient capacity, 12 of the 15 total crossings within the developed areas are undersized. Another major concern in the study area is sediment transport. Sediment loads originating in the mountains upstream of the study area have the potential to clog channels and crossing structures, reducing their already limited capacity. It is likely that this would result in the flooding of residents living along the channel. Westway residents, who live along Flow Path Number 45, expressed their concerns about flooding during Public Meeting Number 1 held in September 2009. These residents were flooded during the storms of 2006.

Flow Path Number 44 has also been identified as having capacity issues through the residential area. The channel, which converges with Flow Path Number 43 upstream, is constricted between properties as it passes through the residential area. This, in conjunction with fill being placed in the channel by property owners, results in the overtopping of the channel and the flooding of downstream residents.

The following sections describe the specific problems associated with each problem area shown on Figure 5-1.

5.1.1 VIN1

Uncontrolled flows from the upstream watershed and the absence of a defined channel cause flooding problems to residences at the upstream portion of Flow Path Number 45A, between Remington Drive and IH-10. Runoff and sediment from undeveloped areas in the watershed enter the upper tributaries of the watershed that converge to form the Flow Path Number 45. Approximately 2,800 feet upstream of the convergence of the tributaries, a portion of the flow branches from a main tributary and continues traveling west toward the intersection of Remington Drive and Southwood Road. When flow reaches this intersection, there is no defined channel, as development has encroached into the channel. At this location, flows spread out along Southwood Road (Flow Path Number 45A), flooding a number of residences and depositing sediment.

5.1.2 VIN2

Uncontrolled flows and insufficient channel capacity along Flow Path Number 45A pose a flood risk to residences adjacent to the channel between Kiely Road and Iron Drive. Flows from the upstream watershed travel along Southwood Road as discussed in Section 5.1.1. After reaching Kingsway Drive, flows enter an earthen channel. Between Iron Drive and Kiely Road, the channel runs through private property. The County does not own or possess a drainage easement through this area making it difficult to improve and maintain the channel. In addition, this portion of the channel has significantly reduced capacity due to encroachment into the channel by residents living adjacent to the channel. The lack of maintenance and reduction in channel capacity causes the channel to overtop and pose a flood risk to residents downstream and adjacent to the channel.

5.1.3 VIN3

Uncontrolled flows originating in the upper end of the watershed and encroachment into the channel by residents of Vinton are resulting in the flooding of residences along Flow Path Number 45, between Tom Mays Drive and De Alva Drive. Runoff from undeveloped areas in the watershed enters the upper tributaries that converge to form the Flow Path Number 45. Additional runoff and sediment are accumulated as flows travel through the steepest part of the watershed. As flows reach Tom Mays Drive, the channel becomes constricted, resulting from encroachment into the channel by residents living adjacent to the channel. The channel has insufficient capacity at this location, resulting in the flooding of residences adjacent to the channel.

5.1.4 VIN4

Uncontrolled flows originating in the upper end of the watershed and encroachment into the channel by residents of Vinton are resulting in the flooding of residences along Flow Path Number 45, between Quejette Road and Rancho Estancias Drive. Runoff from undeveloped areas in the watershed enters the upper tributaries that converge to form the Flow Path Number 45. Additional runoff and sediment are accumulated as flows

travel through the steepest part of the watershed. As flows reach Quejette Road, the channel becomes constricted, resulting from encroachment into the channel by residents living adjacent to the channel. The channel has insufficient capacity at this location, resulting in the flooding of residences adjacent to the channel. The County does not own or possess a drainage easement through this area making it difficult to improve and maintain the channel.

5.1.5 VIN5

Uncontrolled flows originating in the upper end of the watershed and encroachment into the channel by residents of Vinton are resulting in the flooding of residences along Flow Path Number 44, between Selva Drive and Midway Street. Runoff from undeveloped areas in the watershed enters the upper tributaries that converge to form the Flow Path Number 44. Additional runoff and sediment are accumulated as flows travel through the steepest part of the watershed. As flows reach Selva Drive, the channel becomes constricted, resulting from encroachment into the channel by residents living adjacent to the channel. The channel has insufficient capacity at this location, resulting in the flooding of residences adjacent to the channel. The County does not own or possess a drainage easement through this area making it difficult to improve and maintain the channel.

5.1.6 VIN6

The crossing (one 16-foot by 5-foot concrete box culvert [CBC]) at the intersection of Flow Path Number 44 and Doniphan Drive was reported to have insufficient capacity. Based on inspection and hydraulic analysis, the culvert does not have sufficient capacity to convey the 100-year flood through the crossing.

5.1.7 VIN7

The bridge at the intersection of Flow Path Number 45 and The Railroad was reported to have insufficient capacity. Based on inspection and hydraulic analysis, the bridge does not have sufficient capacity to convey the 100-year flood through the crossing.

5.1.8 VIN8

The crossing (two 6-foot by 6-foot CBCs) at the intersection of Flow Path Number 45 and Doniphan Drive was reported to have insufficient capacity. Based on inspection and hydraulic analysis, the culvert does not have sufficient capacity to convey the 100-year flood through the crossing.

5.1.9 VIN9

The crossing (four 36-inch corrugated metal pipes (CMPs) at the intersection of Flow Path Number 45 and A.P. Ramirez Street was reported to have insufficient capacity. Based on inspection and hydraulic analysis, the culvert does not have sufficient capacity to convey the 100-year flood through the crossing.

5.1.10 VIN10

The crossing (two 8-foot by 3-foot CBCs) at the intersection of Flow Path Number 45 and Kiely Road was reported to have insufficient capacity. Based on inspection and hydraulic analysis, the culvert does not have sufficient capacity to convey the 100-year flood through the crossing.

5.1.11 VIN11

The low water crossing at the intersection of Flow Path Number 45 and Quejette Road was reported to be an issue. Without a structure allowing flow to pass under the road surface, flow will continue to pass over the road during storm events.

5.1.12 VIN12

The crossing (thirteen 9-foot by 5-foot CBCs) at the intersection of Flow Path Number 45 and IH-10 northbound off-ramp was reported to have insufficient capacity. Based on inspection and hydraulic analysis, the culvert does not have sufficient capacity to convey the 100-year flood through the crossing.

5.1.13 VIN13

The crossing (two 30-inch reinforced concrete pipes [RCPs]) at the intersection of Flow Path Number 45A and Kiely Drive was reported to have insufficient capacity. Based on inspection and hydraulic analysis, the culvert does not have sufficient capacity to convey the 100-year flood through the crossing.

5.1.14 VIN14

The crossing (three 30-inch RCPs) at the intersection of Flow Path Number 45A and Iron Drive was reported to have insufficient capacity. Based on inspection and hydraulic analysis, the culvert does not have sufficient capacity to convey the 100-year flood through the crossing.

5.2 Canutillo Study Area

A number of flooding and sedimentation issues were identified in the Canutillo Study Area based on information gathered from representatives from El Paso County, residents of the affected areas, as well as field reconnaissance gathered from site visits. These identified issues were the focus of further hydrologic and hydraulic analysis.

The primary concern within the northern portion of the Canutillo Study Area is that many of the upstream watersheds are very large, causing a significant amount of uncontrolled water and sediment to be carried to downstream semi-rural areas via natural arroyos. As the large flows reach the residential areas, the arroyos become less defined, resulting in the flooding of homes and properties.

A particular arroyo of concern is within the northern portion of the Canutillo Study Area is Flow Path Number 42. A number of arroyos, originating in upstream watersheds, converge with Flow Path Number 42 upstream of the Canutillo Heights Community. A

concrete lined channel provides sufficient capacity through the Canutillo Heights Community, but does not extend past El Chanate Drive. At this location, there is no longer a stable channel configuration, resulting in downstream flooding. The County only has drainage easement through the developed portion of Canutillo Heights and does not have the authority to maintain or improve channel segments upstream or downstream of this development.

The southern portion of the Canutillo Study Area has a much smaller contributing watershed compared to the northern area. The primary concern within this area is the ponding of runoff, resulting in flooding of residences and businesses.

A particular area of flooding concern within the southern portion of the Canutillo Study Area is at the intersection of Talbot Avenue and Doniphan Drive, near the Dollar General and the local flea market. This location is a localized topographic depression and does not discharge to the Rio Grande. This watershed area contains no curb and gutter nor is there a clear flow path through the community. This lack of drainage infrastructure requires that the County drain the area by pumping during high runoff events.

The following sections describe the specific problems associated with each problem area shown on Figure 5-2.

5.2.1 CAN1

Uncontrolled flows originating in the upper end of the watershed and the encroachment into the channel by residents of Canutillo are resulting in the flooding of residences along Flow Path Number 42, downstream of the Canutillo Heights Community. Runoff from undeveloped areas in the watershed enters the upper tributaries that converge to form the Flow Path Number 42. Additional runoff is accumulated as flows travel through the steepest part of the watershed. The channel has sufficient capacity to convey flows through the Canutillo Heights Community due to concrete channel improvements, but the improvements do not extend beyond the community. As flows leave the community, the channel becomes earthen and unstable. The channel also becomes constricted, resulting from encroachment into the channel by residents living adjacent to the channel. The channel has insufficient capacity at this location, resulting in the flooding of residences adjacent to the channel. The County does not own or possess a drainage easement through this area making it difficult to improve and maintain the channel.

5.2.2 CAN2

The lack drainage infrastructure within the lower portion of the study area is resulting in the flooding of residences and businesses. County staff noted flooding issues around the intersection of Talbot Avenue and Doniphan Drive, near the Dollar General and the local flea market. This location is a localized topographic depression and does not discharge to the Rio Grande at this time. This watershed area contains no curb and gutter nor is there a clear flow path for the flow to travel through the community. This lack of drainage infrastructure results in the County having to pump water away from the area during high runoff events.

5.2.3 CAN3

The crossing (two 6 foot x 3 foot CBCs) at the intersection of First Avenue Channel and Doniphan Drive was reported to have capacity issues. Based on inspection and hydraulic analysis, the culvert does not have sufficient capacity to convey the 100-year flood through the crossing. Although the culvert is large enough, it slopes to the wrong direction.

5.3 Sparks Arroyo and Sub Basin A Study Area

Problem areas in the Sparks Arroyo and Sub Basin A Study Area were identified as part of an ongoing USACE feasibility study. The following paragraphs represent URS' understanding of the identified problem areas based on this information as well as information provided by representatives from El Paso County, representatives from the City of Socorro, and residents of the affected areas.

Frequent flooding of residences and properties located at the downstream end of the natural arroyos is a primary concern in the Sparks Arroyo and Sub Basin A Study Area. Large flows originating on the upstream mesa are conveyed downstream via natural arroyos before reaching the flat agricultural valley. When flows reach the downstream end of the arroyos they have significant velocities and sediment. At this point, the arroyos become poorly defined and flows spread out causing shallow flooding and sediment deposition. The specific arroyos identified as potential problems in the Sparks Arroyo and Sub Basin A Study Area are Arroyo 1, Arroyo 2, Arroyo 3, Arroyo 4, Arroyo 5, Arroyo 6, and the Sparks Arroyo. According to the ongoing USACE feasibility study, the wastewater treatment plant (WWTP) located at the upstream end of the Sparks Arroyo is also at risk of flooding due to the uncontrolled flows from the upstream watershed.

There are a number of additional flooding problems associated with the Sparks Arroyo. The arroyo has capacity and stability issues along its entire length. These issues pose a significant risk to residences adjacent to the arroyo. In addition, the current configuration of the arroyo downstream of IH-10 poses a significant flood risk to downstream residences in the Valley Ridge Subdivision.

The following sections describe the specific problems associated with each problem area shown on Figure 5-3.

5.3.1 SSA1

Uncontrolled flows originating in the upper end of the watershed pose a flood risk to agricultural land at the mouth of Arroyos 1, 2, and 3, just downstream of IH-10. Residences located downstream of these arroyos, on the south side of the Mesa Spur Drain, are also at risk due to the volume of flow from the arroyos. Runoff from the development in Horizon City and other undeveloped areas on the mesa enters the upper tributaries of the watershed that converge to form the arroyos. Additional runoff and sediment are accumulated as flows travel through the steepest part of the watershed. Approximately 1,500 feet downstream of IH-10, the arroyos become

undefined, with no clear outfall to the Mesa Spur Drain. At this location, flows spread out depositing sediment and posing a flood risk to agricultural land in the area. Due to the large volume of the flow from the arroyos, there is the potential to exceed the capacity of the Mesa Spur Drain and flood residences located south of the channel.

5.3.2 SSA2

Uncontrolled flows originating in the upper end of the watershed pose a flood risk to agricultural land at the mouth of Arroyo 4, just downstream of IH-10. Runoff from undeveloped areas in the watershed is conveyed through the watershed via Arroyo 4. Additional runoff and sediment are accumulated as flows travel through the steepest part of the watershed. Approximately 100 feet upstream of Old Hueco Tanks Road, the arroyo becomes undefined, with no clear outfall to the Mesa Spur Drain. At this location, flows spread out depositing sediment and posing a flood risk to agricultural land in the area.

5.3.3 SSA3

Uncontrolled flows originating in the upper end of the watershed pose a flood risk to agricultural land, residences, and the El Paso Community College Mission del Paso Campus parking lot at the mouth of Arroyos 5 and 6, just downstream of IH-10. Runoff from undeveloped areas in the watershed is conveyed through the watershed via the arroyos. Additional runoff and sediment are accumulated as flows travel through the steepest part of the watershed. Approximately 1,500 feet downstream of IH-10, the arroyos become undefined, with no clear outfall to the Mesa Spur Drain. At this location, flows spread out depositing sediment and posing a flood risk to agricultural land in the area. The El Paso Community College Mission del Paso Campus parking lot is located adjacent to the downstream end of Arroyo 5 and is at risk of flooding and being undermined. In addition, there are a number of residences located adjacent to the downstream end of Arroyo 6 that are at risk of flooding.

5.3.4 SSA4

Uncontrolled flows originating in the upper end of the watershed pose a flood risk to the WWTP at the upstream end of the Sparks Arroyo and to residences located adjacent to the arroyo. Runoff from the development in Horizon City and other undeveloped areas on the mesa enters the upper tributaries of the watershed that converge to form the Sparks Arroyo. According to the ongoing USACE feasibility study, flows from these tributaries pose a flood risk to the WWTP at the upstream end of the Sparks Arroyo. The tributaries converge approximately 300 feet downstream of the WWTP. At this location, flows from the tributaries exceed the capacity of the Sparks Arroyo and pose a flood risk to residences downstream.

5.3.5 SSA5

Uncontrolled flows originating in the upper end of the watershed pose a flood risk to residences located adjacent to the Sparks Arroyo. Runoff from the development in Horizon City and other undeveloped areas on the mesa enters the upper tributaries of the watershed that converge to form the Sparks Arroyo. At the point of convergence,

flows from the tributaries exceed the capacity of the Sparks Arroyo and pose a flood risk to residences adjacent to the arroyo. Additionally, the arroyo is very erodible and large flows have resulted in the widening of the arroyo. Without modification, the widening may begin to impact homes adjacent to the arroyo.

5.3.6 SSA6

Uncontrolled flows originating in the upper end of the watershed pose a flood risk to residences located adjacent to the Sparks Arroyo. Runoff from the development in Horizon City and other undeveloped areas on the mesa enters the upper tributaries of the watershed that converge to form the Sparks Arroyo. At the point of convergence, flows from the tributaries exceed the capacity of the Sparks Arroyo and pose a flood risk to residences adjacent to the arroyo. Additionally, runoff from the Sparks Community exacerbates the capacity issues of the Sparks Arroyo, posing a risk to residences adjacent to the Arroyo, as well as posing a flood risk to residences downstream of the community.

5.3.7 SSA7

Uncontrolled flows originating in the upper end of the watershed pose a flood risk to residences located adjacent to the Sparks Arroyo, downstream of IH-10. Runoff from the development in Horizon City and other undeveloped areas on the mesa enters the upper tributaries of the watershed that converge to form the Sparks Arroyo. Additional runoff and sediment are accumulated as flows travel through the steepest part of the watershed. Runoff from Sparks enters the arroyo before it passes under IH-10. The Valley Ridge Subdivision, south of IH-10 on Sparks Arroyo, is sited within the historic flow path of Sparks Arroyo. A diversion channel upstream of the channel, apparently intended to relocate the arroyo flow path is undersized. As a result, during significant floods arroyo flows follow the historic flow path through the subdivision. The subdivision has high risk for future flooding and sediment deposition.

5.4 Socorro Study Area

A number of flooding and sedimentation issues were identified in the Socorro Study Area based on information gathered from representatives from El Paso County, representatives from the City of Socorro, residents of the affected areas, field reconnaissance gathered from site visits, and the hydrologic and hydraulic analysis.

Frequent flooding of residences and properties located at the downstream end of the natural arroyos is a primary concern in the Socorro Study Area. Large flows originating on the upstream mesa are conveyed downstream via natural arroyos before reaching the flat agricultural valley. When flows reach the downstream end of the arroyos they have significant velocities and sediment. At this point, the arroyos become poorly defined and flows spread out causing shallow flooding and sediment deposition. The specific arroyos identified as potential problems in the Socorro Study Area are Stream 4, Stream 5, and an unnamed stream labeled Stream 5.5 for the purposes of this County SMP.

A basin in El Paso Hills had been alleviating some of the issues described above for downstream areas, but is currently not functioning properly as the embankment has failed.

Several crossings along the Mesa Spur Drain were identified to have insufficient capacity. The Mesa Spur Drain is an agricultural drain that runs from northeast to southwest along the edge of the Socorro Study Area. It has an approximate average depth of 9 feet and a top width of 30 to 40 feet. There were no capacity issues reported for the portion of the channel within this study area. The flow capacity of the Mesa Spur Drain was estimated and compared to crossing capacities to help identify potentially undersized crossings. The crossings along the Mesa Spur Drain located at Carr Road, Coker Road, Anderson Road, and the intersection of the Mesa Drain were identified as problem crossings.

The following sections describe the specific problems associated with each problem area shown on Figure 5-4.

5.4.1 SOC1

The basin in El Paso Hills currently has a failed embankment and is not functioning properly. According to El Paso County staff, a portion of the embankment failed in a 2004 storm event. Per a 2009 site visit, this failure has not been repaired. The basin had been providing some benefit prior to its failure by controlling flows in Stream 4, but is providing minimal benefit in its current state.

5.4.2 SOC2

Uncontrolled flows originating in the upper end of the watershed are causing flooding at the mouth of Stream 4, just upstream of Coker Road. Runoff from development in Horizon City enters the upper tributaries of the watershed that converge to form Stream 4. Additional runoff and sediment are accumulated as flows travel through the steepest part of the watershed. Additional runoff from El Paso Hills enters Stream 4 before it passes under IH-10. Approximately 1,050 feet upstream of Coker Road and the Mesa Spur Drain, the arroyo becomes undefined, with no clear outfall to the Mesa Spur Drain. At this location, flows spread out along Kennstrom Court flooding a number of residences and depositing sediment.

5.4.3 SOC3

Uncontrolled flows originating in the upper end of the watershed are causing flooding at the mouth of Stream 5, upstream of Coker Road. Runoff from undeveloped areas along the mesa is conveyed through the watershed via Stream 5. Additional runoff and sediment are accumulated as flows travel through the steepest part of the watershed. Approximately 1,000 feet upstream of the intersection of Coker Road and Worsham Road, the arroyo becomes undefined, with no clear outfall to the Mesa Spur Drain. At this location, flows spread out flooding a number of residences and depositing sediment.

5.4.4 SOC4

Uncontrolled flows originating in the upper end of the watershed pose a flood risk to residences upstream of the intersection of Stream 5.5 and the Mesa Spur Drain. Runoff from undeveloped areas along the mesa is conveyed through the watershed via Stream 5.5. Additional runoff and sediment are accumulated as flows travel through the steepest part of the watershed. Approximately 1,000 feet upstream of the intersection of Stream 5.5 and Mankato Road, development and agricultural lands are present on both sides of the arroyo. The arroyo passes over a low water crossing at Mankato Road, depositing sediment before converging with the Mesa Spur Drain. The flows in the arroyo are uncontrolled and pose a flood risk to residences and agricultural lands adjacent to Stream 5.5.

5.4.5 SOC5

Although the crossing (one 48-inch CMP) at the intersection of the Mesa Spur Drain and Carr Road was not reported to have capacity problems, based on inspection and hydraulic analysis, the culvert does not have capacity greater than or equal to that of the channel. If the Mesa Spur Drain was flowing bank-fill, this crossing would restrict the capacity of the channel and potentially cause flooding of the agricultural lands adjacent to the channel.

5.4.6 SOC6

Although the crossing (one 48-inch CMP) at the intersection of the Mesa Spur Drain and Coker Road was not reported to have capacity problems, based on inspection and hydraulic analysis, the culvert does not have capacity greater than or equal to that of the channel. If the Mesa Spur Drain was flowing bank-fill, this crossing would restrict the capacity of the channel and potentially cause flooding of the residential and agricultural lands adjacent to the channel.

5.4.7 SOC7

Although the crossing (one 48-inch CMP) at the intersection of the Mesa Spur Drain and Anderson Road was not reported to have capacity problems, based on inspection and hydraulic analysis, the culvert does not have capacity greater than or equal to that of the channel. If the Mesa Spur Drain was flowing bank-fill, this crossing would restrict the capacity of the channel and potentially cause flooding of the residential and agricultural lands adjacent to the channel.

5.4.8 SOC8

Although the crossing (one 60-inch CMP) at the intersection of the Mesa Spur Drain and Mesa Drain was not reported to have capacity problems, based on inspection and hydraulic analysis it appears that the culvert does not have capacity greater than or equal to that of the channel. If the Mesa Spur Drain was flowing bank-fill, this crossing would restrict the capacity of the channel and potentially cause flooding of the residential and agricultural lands adjacent to the channel.

5.5 Hacienda Real Study Area

A number of flooding and sedimentation issues were identified in the Hacienda Real Study Area based on information gathered from representatives from El Paso County, residents of the affected areas, field reconnaissance gathered from site visits, and the hydrologic and hydraulic analysis.

Frequent flooding of residences and properties located at the downstream end of the natural arroyos, at the break in slope as the arroyos enter the flatter agricultural valley, is a primary concern in the Hacienda Real Study Area. Large flows originating on the upstream Mesa are conveyed downstream via natural arroyos before reaching the flat agricultural valley. When flows reach the downstream end of the arroyos, they have significant velocities and sediment. At this point, the arroyos become poorly defined and flows spread out causing shallow flooding and sediment deposition. The specific arroyos identified as potential problems in the Hacienda Real Study Area are Stream 6, Stream 7, Stream 8, Stream 9, Stream 10, Stream 11, Stream 12, Stream 13, and an unnamed stream labeled Stream 13.5 for the purposes of this County SMP.

Several crossings along Mesa Drain, and one along Stream 7 were also identified to have issues with collapse, washout, or insufficient capacity. The Mesa Drain is an agricultural drain that runs from northeast to southwest along the edge of the Hacienda Real Study Area. It has an approximate average depth of 10 feet and a top width of 30 to 40 feet. There were no capacity issues reported for the portion of the channel within this study area. The flow capacity of the Mesa Drain was estimated and compared to crossing capacities to help identify potentially undersized crossings. Six crossings along Mesa Drain were identified to have issues ranging from insufficient capacity to collapse. The crossings along Mesa Drive located at Northloop Drive, FM 1110, the Salatral Lateral, Fenter Road, Celum Road, and at a dirt road upstream of Celum Road were identified as being problem crossings. Additionally, the crossing at the intersection of Stream 7 and Bridgeway Drive was identified as a problem crossing.

The following sections describe the specific problems associated with each problem area shown on Figure 5-5.

5.5.1 HAC1

Uncontrolled flows originating in the upper end of the watershed pose a flood risk to residences within the colonia located to the west of the intersection of IH-10 and FM 1110. Runoff from undeveloped areas along the mesa is conveyed through the watershed via Stream 6. Additional runoff and sediment are accumulated as flows travel through the steepest part of the watershed. Just downstream of IH-10, the arroyo outfalls into a small basin that is located upstream of Ferntower Drive. Once the basin reaches capacity, it overflows into the streets of the colonia, where it is conveyed to the lower end of the colonia. This street flow poses a risk to residences within the colonia.

5.5.2 HAC2

Uncontrolled flows originating in the upper end of the watershed pose a flood risk to residences east of the intersection of Roberts Ranch Road and Wild Horse Road, at the downstream end of Stream 7. Runoff from the development in Horizon City and undeveloped areas along the mesa enters the upper tributaries of the watershed that converge to form Stream 7. Additional runoff and sediment are accumulated as flows travel through the steepest part of the watershed. Approximately 1,900 feet upstream of the intersection of Northloop Drive and Roberts Ranch Road, the arroyo becomes undefined, with no clear outfall to the Mesa Drain. At this location, flows spread out depositing sediment and posing a flood risk to residences in the area.

5.5.3 HAC3

Uncontrolled flows originating in the upper end of the watershed are causing flooding at the mouth of Stream 8, upstream of Northloop Drive. Runoff from undeveloped areas along the mesa is conveyed through the watershed via Stream 8. Additional runoff and sediment are accumulated as flows travel through the steepest part of the watershed. Approximately 1,500 feet east of the intersection of Virrey Road and Reina Road, the arroyo becomes undefined, with no clear outfall to the Mesa Drain. At this location, flows spread out flooding a number of residences and depositing sediment.

5.5.4 HAC4

Uncontrolled flows originating in the portion of the watershed below the Clint Landfill are causing flooding at the convergence of Streams 9 and 10, upstream of Northloop Drive. Runoff from undeveloped areas in the watershed is conveyed downstream via Streams 9 and 10. Additional runoff and sediment are accumulated as flows travel through the steepest part of the watershed. Approximately 2,000 feet upstream of Northloop Drive, the arroyos converge and become undefined, with no clear outfall to the Mesa Drain. At this location, flows spread out flooding a number of residences and depositing sediment.

5.5.5 HAC5

Uncontrolled flows originating in the portion of the watershed below the Clint Landfill pose a flood risk to residences at the mouth of Stream 11, upstream of Northloop Drive. Runoff from undeveloped areas in the watershed are conveyed downstream via Stream 11. Additional runoff and sediment are accumulated as flows travel through the steepest part of the watershed. Approximately 2,500 feet upstream of Northloop Drive, the arroyo becomes undefined, with no clear outfall to the Mesa Drain. At this location, flows spread out depositing sediment and posing a flood risk to residences in the area.

5.5.6 HAC6

Uncontrolled flows originating in the upstream portion of the watershed pose a flood risk to residences at the mouth of the convergence of Streams 12 and 13, upstream of Northloop Drive. Runoff from undeveloped areas in the watershed are conveyed downstream via Streams 12 and 13. The streams converge and additional runoff and

sediment are accumulated as flows travel through the steepest part of the watershed. Approximately 2,150 feet upstream of Northloop Drive, the arroyo becomes undefined, with no clear outfall to the Mesa Drain. At this location, flows spread out depositing sediment and posing a flood risk to residences in the area.

5.5.7 HAC7

Uncontrolled flows originating in the upstream portion of the watershed pose a flood risk to residences at the mouth of Stream 13.5, upstream of Northloop Drive. Runoff from undeveloped areas along the mesa enters the upper tributaries of the watershed that converge to form Stream 13.5. Additional runoff and sediment are accumulated as flows travel through the steepest part of the watershed. Approximately 1,800 feet upstream of Northloop Drive, the arroyo becomes undefined, with no clear outfall to the Mesa Drain. At this location, flows spread out depositing sediment and posing a flood risk to residences in the area.

5.5.8 HAC8

The crossing (five 48-inch CMPs) at the intersection of Stream 13.5 and Bridgeway Drive was reported to have insufficient capacity. Based on inspection and hydraulic analysis, the culvert does not have sufficient capacity to convey the 100-year flood through the crossing.

5.5.9 HAC9

Although the crossing (one 60-inch RCP) at the intersection of the Mesa Drain and Northloop Drive was not reported to have capacity problems, based on inspection and hydraulic analysis, the culvert does not have capacity greater than or equal to that of the channel. If the Mesa Drain was flowing bank-full, this crossing would restrict the capacity of the channel and potentially cause flooding of the agricultural lands adjacent to the channel.

5.5.10 HAC10

The crossing (one 42-inch CMP) at the intersection of the Mesa Drain and FM 1110 (Clint Cut-Off Road) was reported to be collapsed or silted, and it was confirmed that it was not functioning properly during a 2009 site visit. Additionally, based on inspection and hydraulic analysis, the culvert does not have capacity greater than or equal to that of the channel. If the Mesa Drain was flowing bank-full, this crossing would restrict the capacity of the channel and potentially cause flooding of the agricultural lands adjacent to the channel.

5.5.11 HAC11

Although the crossing (one 36-inch RCP) at the intersection of the Mesa Drain and the Salatral Lateral was not reported to have capacity problems, based on inspection and hydraulic analysis, the culvert does not have capacity greater than or equal to that of the channel. If the Mesa Drain was flowing bank-full, this crossing would restrict the capacity of the channel and potentially cause flooding of the agricultural lands adjacent to the channel.

5.5.12 HAC12

Although the crossing (one 72-inch CMP) at the intersection of the Mesa Drain and Fenter Road was not reported to have capacity problems, based on inspection and hydraulic analysis, the culvert does not have capacity greater than or equal to that of the channel. If the Mesa Drain was flowing bank-full, this crossing would restrict the capacity of the channel and potentially cause flooding of the agricultural lands adjacent to the channel.

5.5.13 HAC13

Although the crossing (one 36-inch CMP) at the intersection of the Mesa Drain and the dirt road just upstream of Celum Road was not reported to have capacity problems, based on inspection and hydraulic analysis it appears that the culvert does not have capacity greater than or equal to that of the channel. If the Mesa Drain was flowing bank-full, this crossing would restrict the capacity of the channel and potentially cause flooding of the agricultural lands adjacent to the channel.

5.5.14 HAC14

Although the crossing (one 54-inch CMP) at the intersection of the Mesa Drain and Celum Road was not reported to have capacity problems, based on inspection and hydraulic analysis it appears that the culvert does not have capacity greater than or equal to that of the channel. If the Mesa Drain was flowing bank-full, this crossing would restrict the capacity of the channel and potentially cause flooding of the agricultural lands adjacent to the channel.

5.6 Fabens Study Area

Based on information gathered from representatives from El Paso County, the primary issue identified in the Fabens Study Area is the lack of drainage easements. In addition, a county-owned, Texas Commission on Environmental Quality (TCEQ) regulated dam within the study area currently does not meet TCEQ requirements.

The County currently does not have a drainage easement through the developed portion of the study area, making it difficult to improve or maintain a portion of the San Felipe Arroyo.

A privately constructed ponding area located to the north of the Fabens Community breached during a recent storm event. The channels that contribute flow to this ponding area are currently unnamed and will be identified in this study, from north to south, as Fabens North 1, Fabens North 2 Tributary 1, and Fabens North 2.

The following sections describe the specific problems associated with each problem area shown on Figure 5-6.

5.6.1 FAB1

A privately constructed ponding area located north of the Fabens Community breached during a recent storm event. Per a 2009 site visit, this failure has not been repaired.

The basin had been providing some benefit prior to its failure by controlling flows in Fabens North 1, Fabens North 2 Tributary 1, and Fabens North 2, but is providing minimal benefit in its current state.

5.6.2 FAB2

The San Felipe Arroyo, which runs through the developed area, has sufficient flow capacity. However, there is concern that without a drainage easement through the developed portion of the study area, it is very difficult for the County to maintain the existing drainage channel. Without proper maintenance, there are likely to be problems associated with the channel in the future.

5.6.3 FAB3

Fabens Dam is the only TCEQ regulated dam owned by the County. TCEQ regulations require that a dam of this size pass 75% of the flood caused by a Probable Maximum Precipitation (PMP) event without overtopping and potentially breaching the dam. Based on hydrologic analysis, the dam does not currently meet this requirement.

5.7 Tornillo Study Area

Based on information gathered from representatives from El Paso County and field reconnaissance, the primary issue identified in the Tornillo Study Area is the flooding of public and private property due to uncontrolled flows from upstream watersheds. As channels originating in the upstream watersheds reach the developed community of Tornillo, they become less defined and the accumulated flow spreads out resulting in flooding of residents.

One channel of particular concern within the Tornillo Study Area is the High School Channel. The channel conveys large flows from the upstream watersheds, past a high school, to the developed community below. As the channel approaches the high school, it is redirected south to a local basin. During the storm of 2006, the side of the channel was breached, causing the high school and the community downstream to flood. In an attempt to stop erosion of the channel bank, the County has constructed erosion protection along the west side of the channel using a recycled tire-riprap combination. A field visit conducted for this study indicated evidence of undercutting of the erosion protection.

The local basin, which appears to be an old borrow pit, lies south of the high school and collects flow from both High School Channel and South High School Channel. The basin is undersized for the amount of flow which is expected to reach the area.

The other three channels located to the south of the South High School Channel are currently unnamed. For the purpose of this study, these channels will be known as, from north to south: Flow Path T, Tornillo Handle Channel 1, and Tornillo Handle Channel 2. Currently, the crossing located at OT Smith Road does not provide sufficient capacity for the Tornillo Handle Channel 1. As a result, the upstream channel overtops and floods the residents along the road. Flows from Flow Path T, Tornillo Handle Channel 1, and Tornillo Handle Channel 2 travel through unconfined channels

before entering the community of Tornillo. The channels become undefined within the community resulting in flooding of residents within the area.

The following sections describe the specific problems associated with each problem area shown on Figure 5-7.

5.7.1 TOR1

Uncontrolled flows originating in the upper end of the watershed pose a flood risk to residences downstream of High School Channel and South High School Channel. Runoff from undeveloped areas in the watershed enters the upper tributaries that converge to form the channels. Additional runoff and sediment are accumulated as flows travel through the steepest part of the watershed. Approximately 1,300 feet downstream of Valley Gin Road, the channels converge before discharging into a local basin. The basin is currently undersized, posing a flood risk to residences downstream.

5.7.2 TOR2

Channel bank instability along the High School Channel poses a flood risk to the high school and to residences downstream of the high school. Near the high school, the High School Channel changes in direction, diverting flows to a localized basin on the south side of the high school. During the storm of 2006, the side of the channel was breached, causing the high school and the community downstream to flood. The County has constructed erosion protection along the west side of the channel using a recycled tire-riprap combination. A field visit conducted for this study indicated evidence of undercutting of the erosion protection. Until this channel is stabilized, the high school and residences downstream of the high school will be at risk of flooding.

5.7.3 TOR3

Uncontrolled flows originating in the upper end of the watershed pose a flood risk to residences downstream of Flow Path T, south of Highland Road. Runoff from undeveloped areas in the watershed enters the upper tributaries that converge to form the channel. Additional runoff and sediment are accumulated as flows travel through the steepest part of the watershed. Near Highland Road, the channel discharges into a local basin. The basin previously provided some protection during small storm events, but has breached and is currently providing minimal benefit. The downstream community is at risk of flooding.

5.7.4 TOR4

Uncontrolled flows originating in the upper end of the watershed are causing flooding at the mouth of Tornillo Handle Channel 2, downstream of Big Master Road. Runoff from undeveloped areas in the watershed is conveyed via Tornillo Handle Channel 2. Additional runoff and sediment are accumulated as flows travel through the steepest part of the watershed. Downstream of Big Master Road, the arroyo becomes undefined, flooding a number of residences.

5.7.5 TOR5

Uncontrolled flows originating in the upper end of the watershed are causing flooding at the mouth of Tornillo Handle Channel 1, downstream of Big Master Road. Runoff from undeveloped areas in the watershed is conveyed via Tornillo Handle Channel 1. Additional runoff and sediment are accumulated as flows travel through the steepest part of the watershed. Downstream of Big Master Road, the arroyo becomes undefined, flooding a number of residences.

5.7.6 TOR6

The crossing (two 36-inch pipes) at the intersection of Tornillo Handle Channel 2 and OT Smith Road was reported to have insufficient capacity. Based on inspection and hydraulic analysis, the culvert does not have sufficient capacity to convey the 100-year flood through the crossing.

✘ Problem Crossing
 Problem Area
— Study Reach

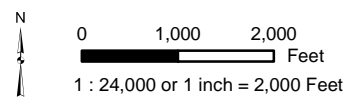
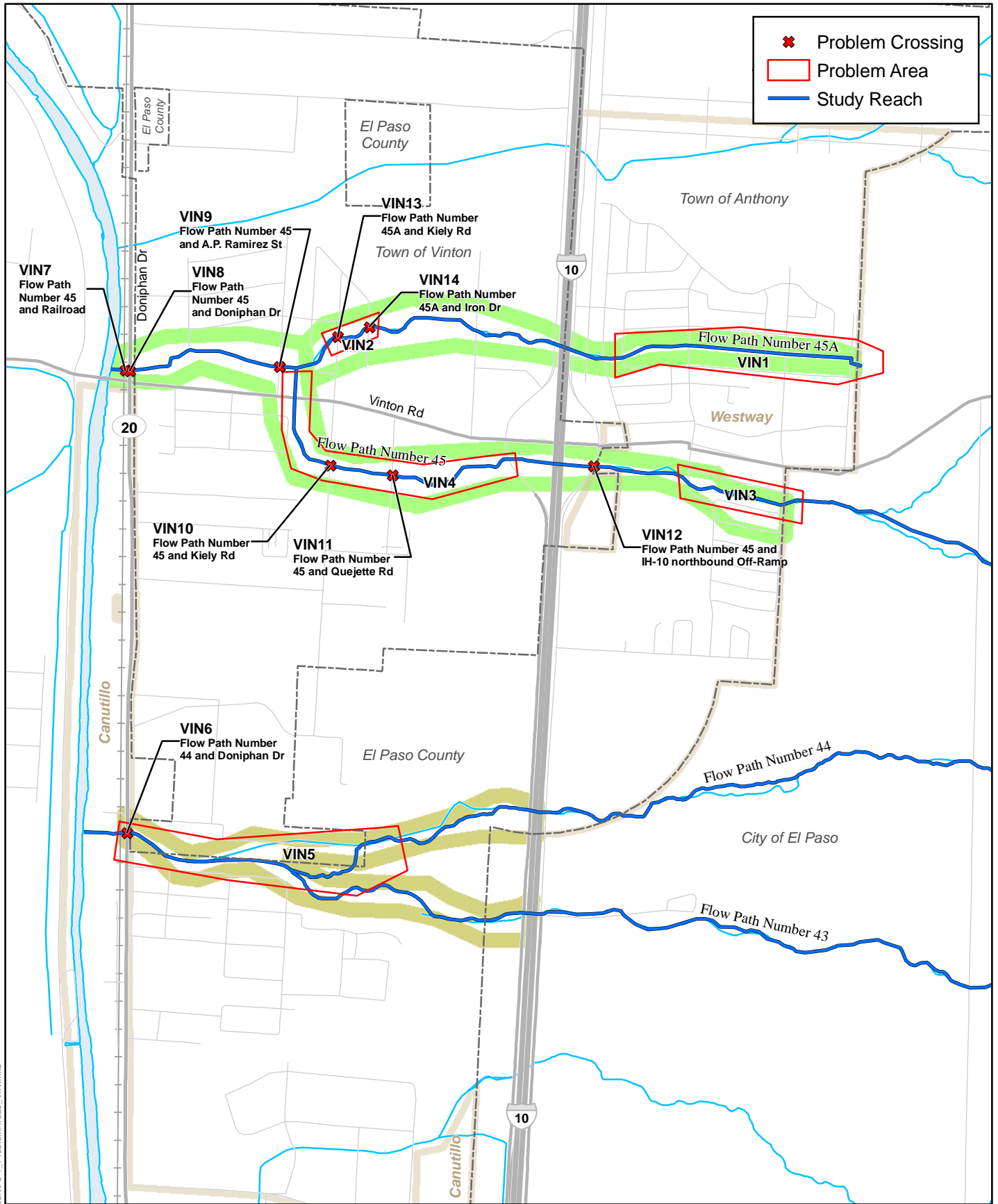

Legend

 Study Area	— River, Stream, Canal
 City Master Plan Study Area	~ Water Body
 Corporate Boundary	 Major Road
 Designated Place	 Minor Road
	 Railroad

Identified Problem Areas
Vinton Study Area
 El Paso County
 Stormwater Master Plan

August 2010 Figure 5-1

P:\GIS_Projects\EP\WVICounty\SMP\MXD\Report\F5-1_ProblemAreas_VIN.mxd



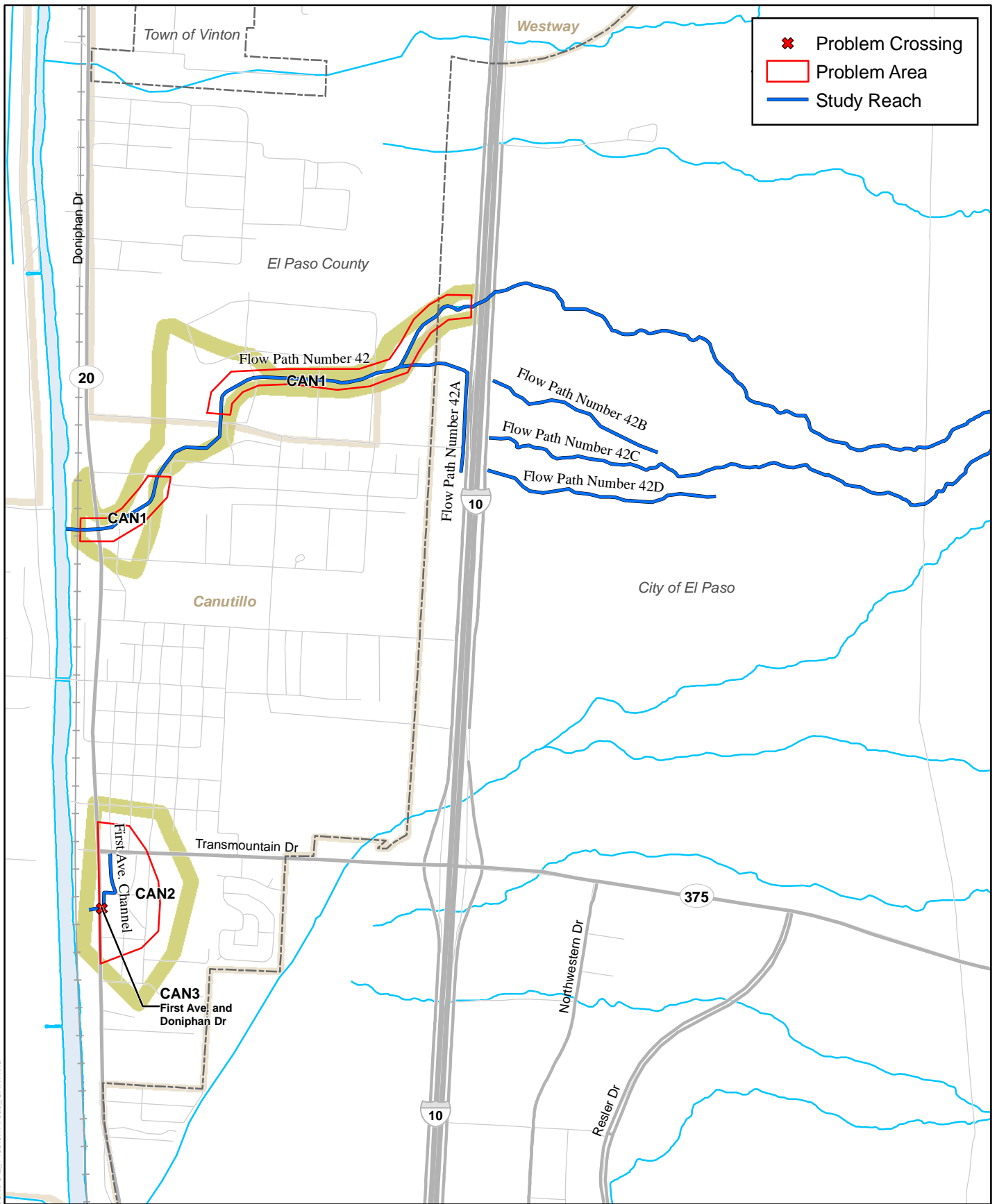

P:\GIS_Projects\EP\WUC_county\SM\PM\XD\Report\F5-2_ProblemAreas_CAN.mxd



0 1,000 2,000
 Feet
 1 : 24,000 or 1 inch = 2,000 Feet



URS



Legend

- Study Area
- Corporate Boundary
- Designated Place
- River, Stream, Canal
- Water Body
- Major Road
- Minor Road
- Railroad

**Identified Problem Areas
 Canutillo Study Area**

El Paso County
 Stormwater Master Plan

August 2010

Figure 5-2

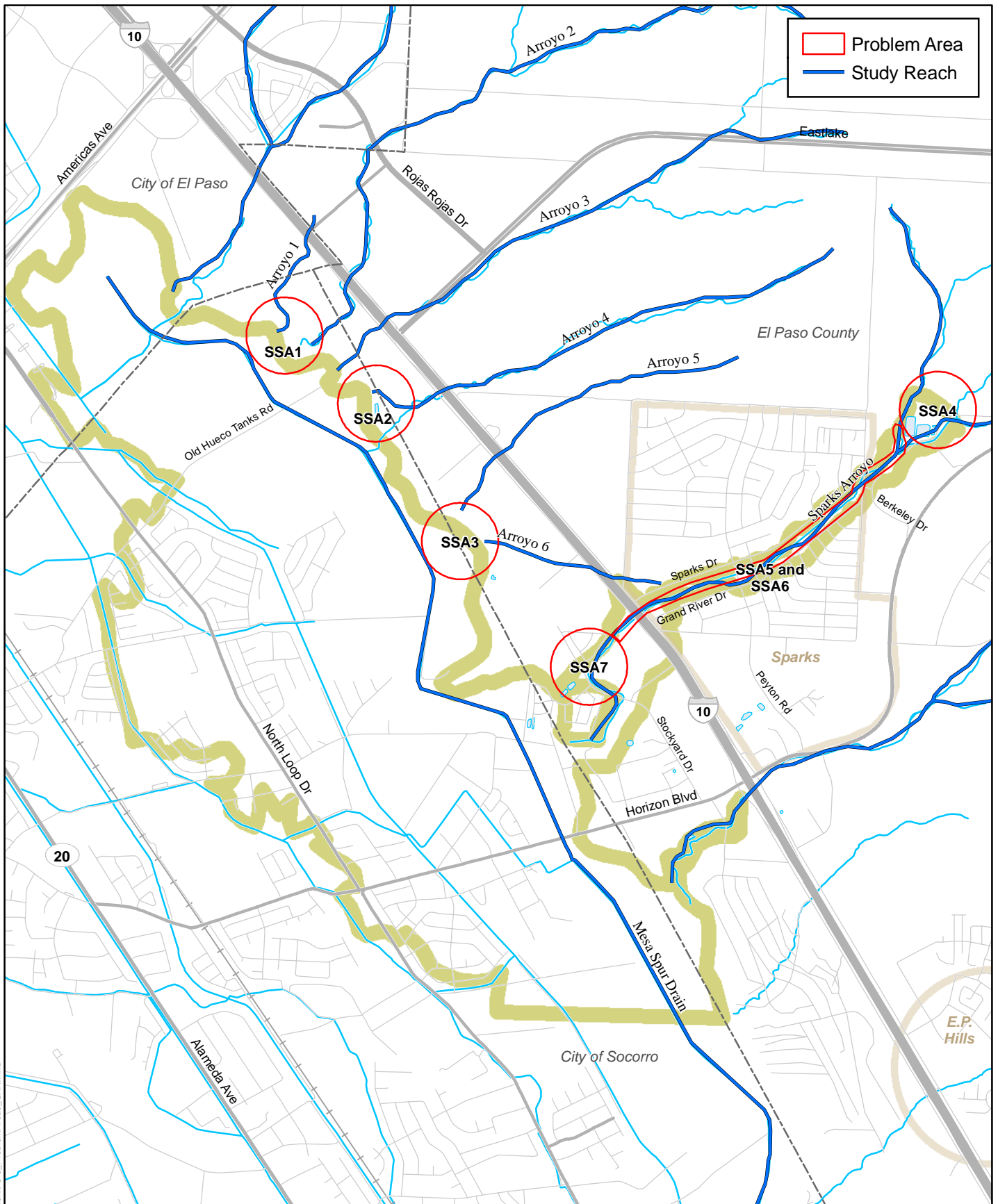

P:\GIS_Projects\EP\WUC_county\SM\PM\XD\Report\EF5-3_ProblemAreas_SAA.mxd



0 1,500 3,000
 Feet
 1 : 36,000 or 1 inch = 3,000 Feet



URS



Legend

- Study Area
- Corporate Boundary
- Designated Place
- River, Stream, Canal
- Water Body
- Major Road
- Minor Road
- + Railroad

**Identified Problem Areas
 Sparks Arroyo and Sub Basin A
 Study Area**

El Paso County
 Stormwater Master Plan

August 2010

Figure 5-3

✖ Problem Crossing
 Problem Area
 Study Reach

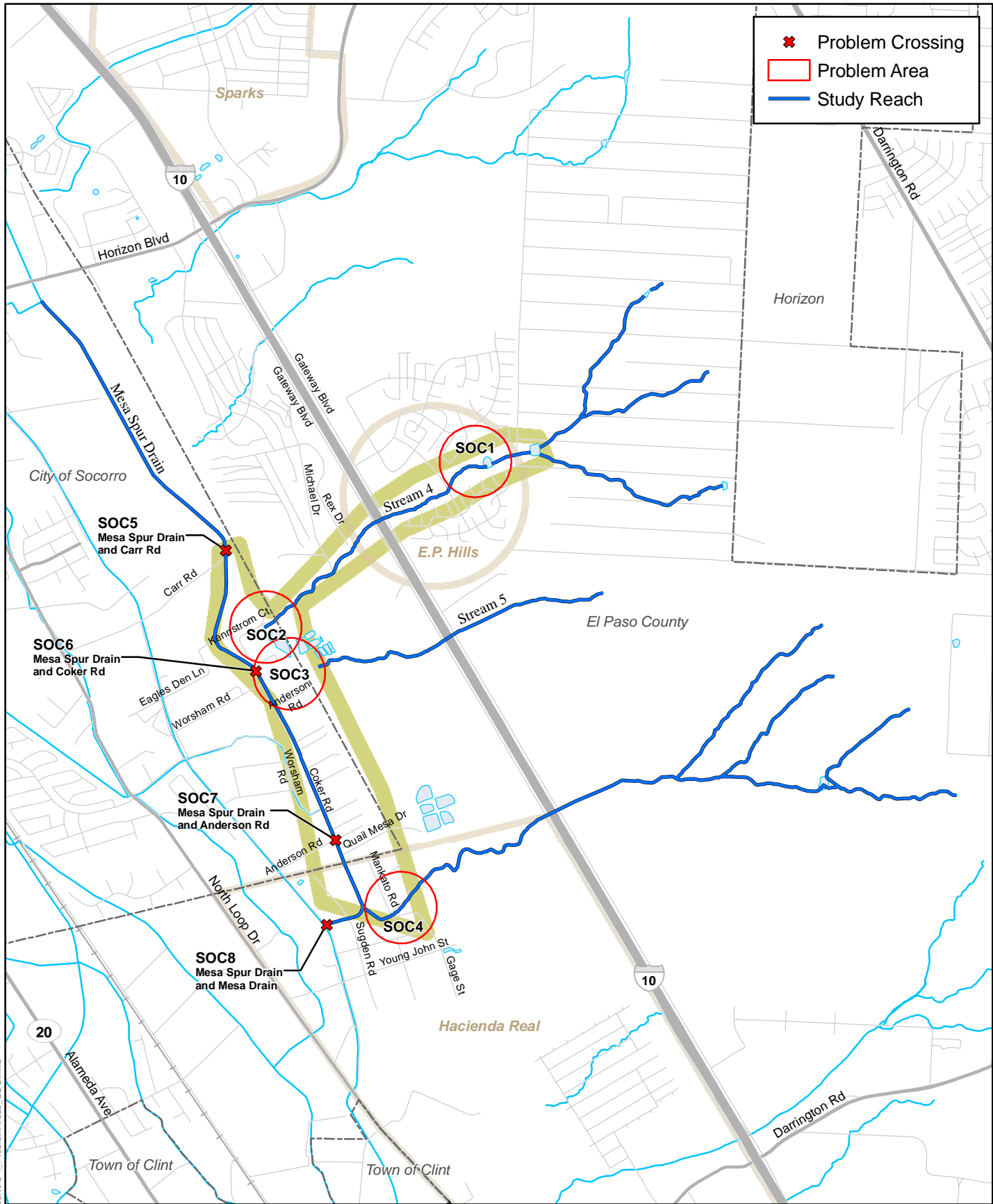

P:\GIS_Projects\EP\WUC\county\SMP\MXD\Report\F5-4_ProblemAreas_SOC.mxd

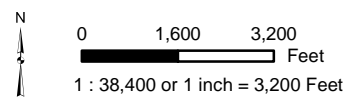

Legend

- Study Area
- Corporate Boundary
- Designated Place
- River, Stream, Canal
- Water Body
- Major Road
- Minor Road
- | Railroad

Identified Problem Areas
Socorro Study Area
 El Paso County
 Stormwater Master Plan

August 2010	Figure 5-4
-------------	------------

✖ Problem Crossing
 Problem Area
 Study Reach

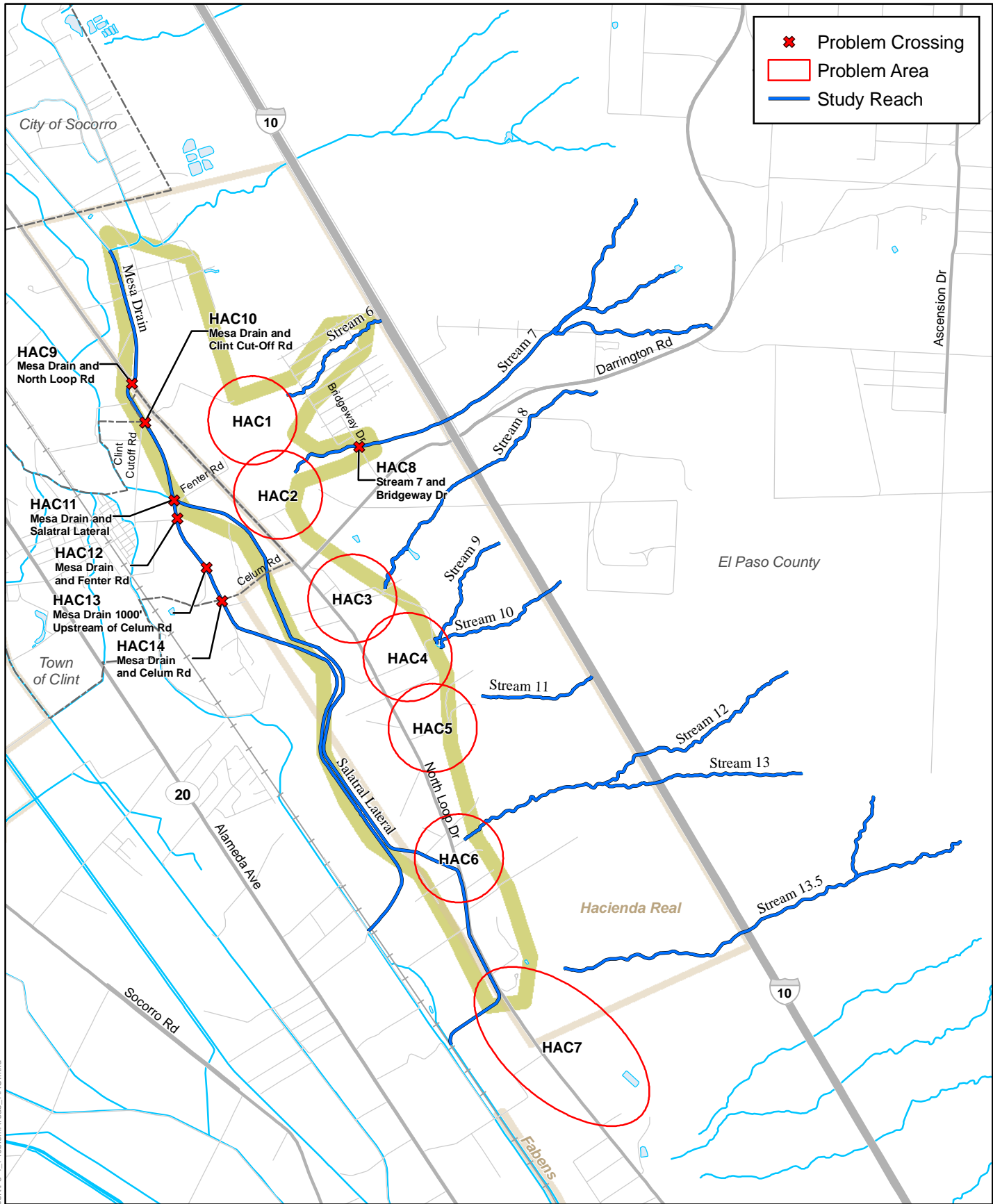

P:\GIS_Projects\EP\WUC\county\SMP\MXD\Report\F5-4_ProblemAreas_HAC.mxd

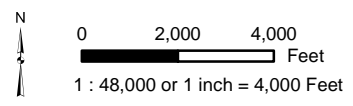

Legend

 Study Area	 River, Stream, Canal
 Corporate Boundary	☁ Water Body
 Designated Place	 Major Road
	 Minor Road
	 Railroad

**Identified Problem Areas
 Hacienda Real Study Area**
 El Paso County
 Stormwater Master Plan

August 2010	Figure 5-5
-------------	------------



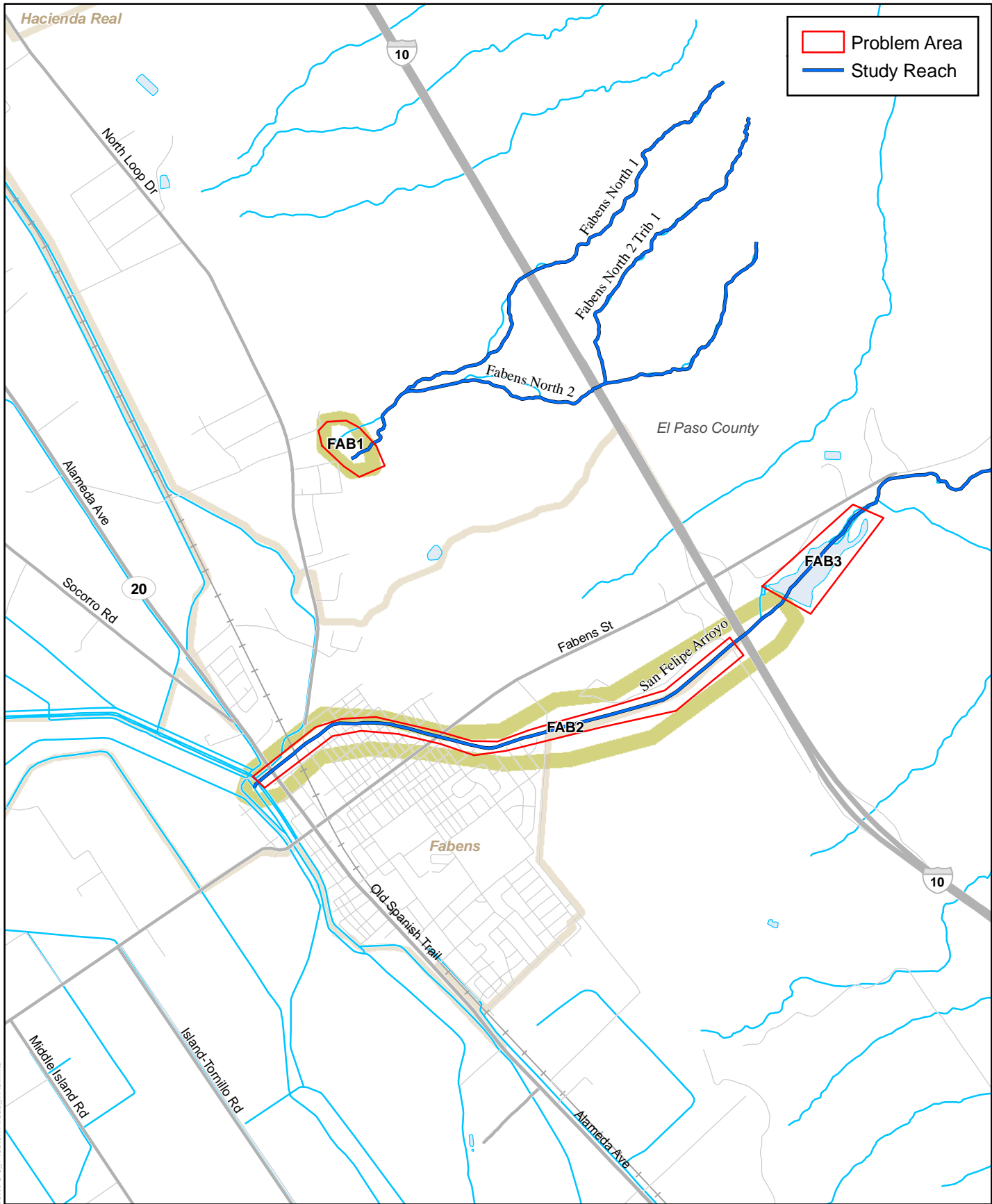

	Problem Area
	Study Reach



0 1,500 3,000
 Feet
 1 : 36,000 or 1 inch = 3,000 Feet

Legend

- Study Area
- Corporate Boundary
- Designated Place
- River, Stream, Canal
- Water Body
- Major Road
- Minor Road
- Railroad

**Identified Problem Areas
 Fabens Study Area**

El Paso County
 Stormwater Master Plan



August 2010

Figure 5-6

P:\GIS_Projects\EP\WUC\county\SM\PM\XD\Report\F5-5_ProblemAreas_FAB.mxd

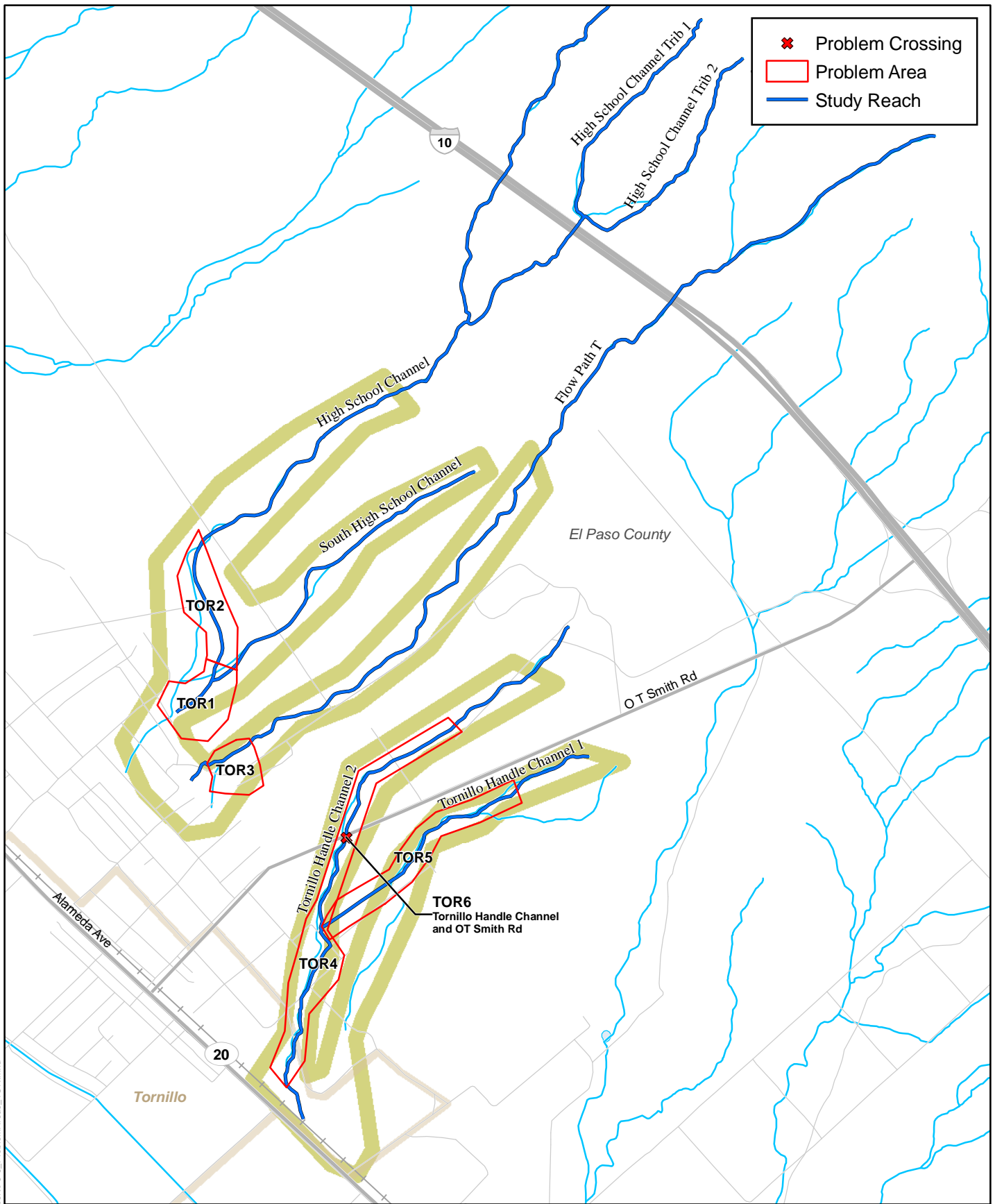

P:\GIS_Projects\EP\WVIC\county\SMP\MXD\Report\F5-6_ProblemAreas_TOR.mxd



0 1,000 2,000
Feet
1 : 24,000 or 1 inch = 2,000 Feet



URS



Legend

- Study Area (Green shaded area)
- Corporate Boundary (Dashed line)
- Designated Place (Brown shaded area)
- River, Stream, Canal (Blue line)
- Water Body (Blue area)
- Major Road (Thick grey line)
- Minor Road (Thin grey line)
- Railroad (Grey line with cross-ticks)

**Identified Problem Areas
Tornillo Study Area**

El Paso County
Stormwater Master Plan

August 2010

Figure 5-7

6.0 RECOMMENDED IMPROVEMENTS

As discussed in the earlier sections of the County SMP, stormwater infrastructure deficiencies were identified within each El Paso County Study Area. A series of project alternatives were developed to address these inadequacies. During working meetings with the County and EPWU, the various alternatives were discussed and a preferred alternative was selected.

Projects and project costs can be found summarized in Table 6-1. All costs presented in this section are conceptual in nature and were estimated using the methodology provided in Appendix C.

The selected alternative for each project is discussed below. Information on the other alternatives can be found in Appendix C.

6.1 Vinton Study Area

The issues of concern within the Vinton Study Area are largely due to the lack of capacity and access to the drainage facilities along the natural arroyos. Large flows traveling down the mountainside carry a large amount of sediment. As the flow reaches the flatter residential area, the flow slows, depositing much of the sediment. The capacity of the arroyos have been reduced due to the lack of maintenance and residents filling the arroyo to utilize more of their property. To address these inadequacies in the current stormwater facilities, a series of projects was identified.

6.1.1 Specific Projects

6.1.1.1 Flow Path Number 45A Diversion (VIN1)

Figure 6-1 shows Flow Path Number 45 and a tributary to Flow Path Number 45 in the area immediately upstream of the El Paso Natural Gas (EPNG) Pipeline Road. Immediately upstream of the intersection of this tributary with the road, flows from the tributary split during floods, with the bulk of the flows proceeding southwest to the junctions with Flow Path Number 45. The remainder of the flood flow in this tributary heads due west across Westway Boulevard and the EPNG Pipeline Road. This flow is marked "Split Flow" on Figure 6-1. This "Split Flow" is shown on Figure 6-2 arriving from the east and entering Vinton near Banker Road, Flow Path Number 45A, and their intersection with Remington Drive. The "Split Flow" exceeds the capacity of the existing Flow Path Number 45A and causes flood damages in this part of Vinton and downstream to the immediate west.

Project VIN1 incorporates three improvements to address this issue. Basin A (Figure 6-1) is designed to capture flood flows and sediment from the tributary to Flow Path Number 45. A diversion channel (Figure 6-2) is designed parallel to and upstream of Remington Drive to intercept flood flows from the watershed downstream of Basin A. This diversion channel discharges into Flow Path Number 45 upstream of Tom Mays Drive. The diversion would increase flood flows in Flow Path Number 45 without a linked improvement along that channel. Basin B (Figure 6-1) is the proposed

improvement on Flow Path Number 45. This basin intercepts flood and sediment flows from Flow Path Number 45; resulting in a net reduction of flows into Vinton along Flow Path Number 45. Project VIN3, which is for channel improvement within Vinton along Flow Path Number 45, is dependent upon the flow reductions achieved by Basins A and B.

The proposed basin on Flow Path Number 45 (Basin B on Figure 6-1) requires approximately 200 acre-feet of excavation for flood and sediment pool storage, and the proposed basin on the flow path contributing to Flow Path Number 45 (Basin A on Figure 6-1) requires approximately 380 acre-feet of excavation for flood and sediment pool storage. Sediment sources are identified in the upstream watershed of Flow Path Number 45 within the City SMP. The sediment portions of the basins are included to accommodate sediment laden flows from these sources.

The estimated cost of this project does not include the cost of property acquisition, as the basins are to be located on EPWU property.

6.1.1.2 Flow Path Number 45A Channel Improvements (VIN2)

This project involves improvements to Flow Path Number 45A from approximately 230 feet upstream of Iron Drive to approximately 260 feet downstream of Kiely Road. The existing undersized channel is a V-ditch with a depth of approximately 2 feet and a top width of 40 feet. The proposed channel section is 5 feet deep, with 2 to 1 (horizontal to vertical) side slopes, and a bottom width of 15 feet. The purpose of these improvements is to provide sufficient capacity within the channel to convey the 100-year flood, assuming project VIN1 is completed. The remainder of the downstream channel has capacity for the 100-year flood. These proposed improvements are shown on Figure 6-3.

6.1.1.3 Flow Path Number 45 Upper Section (VIN3)

This project involves improvements to the upper portion of Flow Path Number 45 from Tom Mays Drive to De Alva Drive. The existing channel is a V-ditch that is 1.5 feet deep and has a top width of 45 feet. The proposed channel is 3 feet deep, has 2 to 1 side slopes, and a bottom width of 30 feet. The purpose of these improvements is to provide sufficient capacity within the channel to convey the 100-year flood, assuming project VIN1 is completed. There are currently low water crossings at Tom Mays Drive and De Alva Drive. It is recommended that these remain low water crossings. These proposed improvements are shown on Figure 6-2.

For VIN3 to be successful, VIN1 must be complete.

6.1.1.4 Flow Path Number 45 Middle Section (VIN4)

This project involves improvements to Flow Path Number 45 from southbound IH-10 on-ramp to the confluence of Flow Path Number 45A. The existing earthen channel is 4 feet deep, with 4 to 1 side slopes, and a bottom width of 2 feet. The proposed channel is earthen, 9.5 feet deep, with 2 to 1 side slopes, and a bottom width of 20 feet. The purpose of these improvements is to provide sufficient capacity within the channel

to convey the 100-year flood, assuming project VIN1 is completed. These proposed improvements are shown on Figure 6-3.

6.1.1.5 Flow Path Number 44 (VIN5)

This project involves acquiring ROW property along Flow Path Number 44 within the residential area. This would allow the County to maintain this portion of the channel. In addition, this project involves 2,050 feet of channel improvements. The proposed earthen channel has a bottom width of approximately 25 feet, 3 to 1 side slopes, and would be approximately 6 feet deep. The purpose of these improvements is to provide enough potential capacity to convey the 100-year flood. These proposed improvements are shown on Figure 6-4.

6.1.1.6 Doniphan Drive Crossing (VIN6)

This project involves removing the existing 16-foot by 5-foot CBC at the intersection of Flow Path Number 44 and Doniphan Drive and replacing it with three 9-foot by 8-foot CBCs. This culvert size will provide sufficient capacity for the 100-year flood to be conveyed through the crossing without overtopping the road. This proposed improvement is shown on Figure 6-4.

6.1.1.7 Railroad Crossing (VIN7)

This project involves replacing the existing bridge at the intersection of Flow Path Number 45 and the Railroad with a bridge that does not impede the flow of water in the channel. In order for the bridge to not impede flow, the bridge should match the channel geometry and the low chord of the bridge should be above the channel bank elevation. The purpose of this improvement is to provide sufficient capacity for the 100-year flood to be conveyed through the crossing with overtopping the road. This proposed improvement is shown on Figure 6-5.

6.1.1.8 Doniphan Drive Crossing (VIN8)

This project involves replacing the existing two 6-foot by 6-foot CBCs at the intersection of Flow Path Number 45 and Doniphan Drive with a bridge that does not impede the flow of water in the channel. In order for the bridge to not impede flow, the bridge should match the channel geometry and the low chord of the bridge should be above the channel bank elevation. The purpose of this improvement is to provide sufficient capacity for the 100-year flood to be conveyed through the crossing without overtopping the road. This proposed improvement is shown on Figure 6-5.

6.1.1.9 AP Ramirez Street Crossing (VIN9)

This project involves replacing the existing four 36-inch CMPs at the intersection of Flow Path Number 45 and AP Ramirez Street with a bridge that does not impede the flow of water in the channel. In order for the bridge to not impede flow, the bridge should match the channel geometry and the low chord of the bridge should be above the channel bank elevation. The purpose of this improvement is to provide sufficient capacity for the 100-year flood to be conveyed through the crossing without overtopping the road. This proposed improvement is shown on Figure 6-3.

6.1.1.10 Kiely Road Crossing (VIN10)

This project involves replacing the existing two 8-foot by 3-foot CBCs at the intersection of Flow Path Number 45 and Kiely Road with a bridge that does not impede the flow of water in the channel. In order for the bridge to not impede flow, the bridge should match the channel geometry and the low chord of the bridge should be above the channel bank elevation. The purpose of this improvement is to provide sufficient capacity for the 100-year flood to be conveyed through the crossing without overtopping the road. This proposed improvement is shown on Figure 6-3.

6.1.1.11 Quejette Road Crossing (VIN11)

This project involves replacing the existing low water crossing at the intersection of Flow Path Number 45 and Quejette Road with a bridge that does not impede the flow of water in the channel. In order for the bridge to not impede flow, the bridge should match the channel geometry and the low chord of the bridge should be above the channel bank elevation. The purpose of this improvement is to provide sufficient capacity for the 100-year flood to be conveyed through the crossing without overtopping the road. This proposed improvement is shown on Figure 6-3.

6.1.1.12 IH-10 Northbound Off-ramp Crossing (VIN12)

This project involves the addition of 3 more barrels to the existing 13 barrel structure to make a total of sixteen 9-foot by 5-foot CBCs at the intersection of Flow Path Number 45 and the Northbound off-ramp of IH-10. The purpose of this improvement is to provide sufficient capacity for the 100-year flood to be conveyed through the crossing without overtopping the road. This proposed improvement is shown on Figure 6-2.

6.1.1.13 Kiely Road Crossing with Flow Path Number 45A (VIN13)

This project involves replacing the existing two 30-inch RCPs at the intersection of Flow Path Number 45A and Kiely Road with five 7-foot by 4-foot CBCs. The purpose of this improvement is to provide sufficient capacity for the 100-year flood to be conveyed through the crossing without overtopping the road. This proposed improvement is shown on Figure 6-3.

6.1.1.14 Iron Drive Crossing (VIN14)

This project involves replacing the existing three 30-inch RCPs at the intersection of Flow Path Number 45A and Iron Drive with six 6-foot by 6-foot CBCs. The purpose of this improvement is to provide sufficient capacity for the 100-year flood to be conveyed through the crossing without overtopping the road. This proposed improvement is shown on Figure 6-3.

6.2 Canutillo Study Area

6.2.1 Specific Project

Flooding within the Canutillo Study Area is largely a result of a lack of flood and sediment control along the arroyos and within the residential area. Additionally, the lack of drainage facilities in urban areas results in the ponding of water in streets and in residential areas. To address these inadequacies in the current stormwater infrastructure, a series of projects was identified.

6.2.1.1 Flow Path Number 42 (CAN1)

This project involves constructing 1,240 feet of concrete lined channel along Flow Path Number 42, in addition to acquiring ROW property for maintenance of the channel. The proposed concrete channel will consist of a bottom width of approximately 30 feet, 2 to 1 side slopes, and would be approximately 5 feet deep. The purpose of these improvements is to provide sufficient capacity within the channel to convey the 100-year flood. These proposed improvements are shown on Figure 6-6.

Additionally, the section of channel located between IH-10 and Los Mochis Road is currently undeveloped. Future development must ensure the channel has capacity to convey the 100-year flood and provide necessary maintenance access to the County.

6.2.1.2 Localized Flooding along First Avenue Channel (CAN2)

This project involves constructing a retention basin on a currently vacant lot east of the intersection of West Avenue and Third Avenue. The proposed embankment is approximately 6 feet tall and provides approximately 21 acre-feet of storage for flood and sediment pool. This project also includes the construction of approximately 1,665 feet of 48-inch RCP storm drain to connect the proposed basin to an existing basin located north of Mowad Road. This storm drain will allow the two basins to act as inter-connected ponds during significant runoff events.

In addition, the project involves constructing a retention basin west of Doniphan Drive across from the flea market. Due to spatial limitations, this basin will not have the capacity to retain the 100-year flood; the basin will act as a temporary holding area and pumping will be required to remove water during significant runoff events. To direct flow to the temporary retention basin, the project calls for constructing 143 feet of concrete lined channel parallel to Doniphan Drive. The proposed channel has a bottom width of approximately 4 feet, 2 to 1 side slopes, and would be approximately 3 feet deep. As part of channel construction, the project requires the replacement of the existing two 12-inch polyvinyl chloride (PVC) pipes at the intersection of First Avenue Channel and West Avenue with a 6-foot by 3-foot CBC. These proposed improvements are shown on Figure 6-7.

6.2.1.3 Doniphan Drive Crossing (CAN3)

This project involves replacing the existing two 6-foot by 3-foot CBCs at the intersection of First Avenue Channel and Doniphan Drive with two 6-foot by 3-foot CBCs, ensuring

the culvert is sloped to drain to the proposed basin. Although the existing culvert size provides sufficient capacity, the culvert is not sloping in the correct direction. The proposed culvert size and placement will provide sufficient capacity for the 100-year flood to be conveyed through the crossing without overtopping the road. This proposed improvement is shown on Figure 6-7.

6.3 Sparks Arroyo and Sub Basin A Study Area

Flooding within the Sparks Arroyo and Sub Basin A Study Area is largely a result of a lack of flood and sediment control structures along the natural arroyos. Large flows from the high mesa are uncontrolled and become loaded with sediment as they approach the valley below. When these flows reach the valley, they spread out and sheet flow, forming alluvial fans. In addition, there are capacity and stability issues with the Sparks Arroyo, which runs through the Sparks urban area.

As discussed earlier, the USACE has an ongoing feasibility study evaluating the drainage problems along Sparks Arroyo and Sub Basin A. URS developed seven projects (SSA1 - SSA7) to address these problems based on the general hydrologic information provided by the USACE. The final projects proposed by the USACE may differ from the URS projects (SSA1 - SSA7) discussed in the following sections.

6.3.1 Specific Projects

6.3.1.1 A1-A3 Basin (SSA1)

This project involves constructing a detention basin at the lower end of Arroyos 1, 2, and 3. The proposed embankment is approximately 41 feet tall and requires approximately 306 acre-feet of excavation for flood and sediment pool storage. The outlet structure for this basin consists of a 2-foot RCP. The basin has two primary purposes:

1. Capture sediment being transported down the arroyos and reduce deposition in the downstream channels and floodplains; and
2. Detain the flood flows coming down the arroyos and release them slowly from the detention basin at a rate that will reduce flooding downstream.

These proposed improvements are shown on Figure 6-8.

6.3.1.2 A4 Basin (SSA2)

This project involves constructing a detention basin at the lower end of Arroyo 4. The proposed embankment is approximately 22 feet tall and requires approximately 46 acre-feet of excavation for flood and sediment pool storage. The outlet structure for this basin consists of a 2-foot RCP. The basin has two primary purposes:

1. Capture sediment being transported down the arroyos and reduce deposition in the downstream channels and floodplains; and
2. Detain the flood flows coming down the arroyos and release them slowly from the detention basin at a rate that will reduce flooding downstream.

These proposed improvements are shown on Figure 6-8.

6.3.1.3 A5-A6 Basin (SSA3)

This project involves constructing a detention basin at the lower end of Arroyos 5 and 6. The proposed embankment is approximately 36 feet tall and requires approximately 67 acre-feet of excavation for flood and sediment pool storage. The outlet structure for this basin consists of a 2-foot RCP. The basin has two primary purposes:

1. Capture sediment being transported down the arroyos and reduce deposition in the downstream channels and floodplains; and
2. Detain the flood flows coming down the arroyos and release them slowly from the detention basin at a rate that will reduce flooding downstream.

In addition to the detention basin, 1,100 feet of concrete lined channel is proposed along Arroyo 5 as part of this project. The proposed channel has a bottom width of approximately 20 feet, 3 to 1 side slopes, and is approximately 3 feet deep. The purpose of this channel is to divert flows from Arroyo 5 into the basin and to prevent further erosion and encroachment of the channel into the adjacent properties. These proposed improvements are shown on Figure 6-9.

6.3.1.4 Sparks Basin (SSA4)

This project involves constructing a detention basin at the upper end of the Sparks Arroyo, just upstream of the WWTP. The proposed embankment is approximately 37 feet tall and requires approximately 139 acre-feet of excavation for flood and sediment pool storage. The outlet structure for this basin consists of a 4-foot RCP. The basin has two primary purposes:

1. Capture sediment being transported down the arroyos and reduce deposition in the downstream channels and floodplains; and
2. Detain the flood flows coming down the arroyos and release them slowly from the detention basin at a rate that will reduce flooding downstream.

These proposed improvements are shown on Figure 6-10.

6.3.1.5 Sparks Arroyo (SSA5)

This project involves reshaping and lining approximately 10,300 feet of the Sparks Arroyo, between the proposed Sparks Basin and Stockyard Drive. The proposed channel has a bottom width of approximately 25 feet, 3 to 1 side slopes, and is approximately 5 feet deep. The purpose of the improvements is to stabilize the channel to prevent further erosion and encroachment into adjacent properties. In addition, a crossing structure consisting of six 10-foot by 4-foot CBCs is proposed at Stockyard Drive. These proposed improvements are shown on Figure 6-10.

6.3.1.6 Sparks Ponds (SSA6)

This project involves constructing two retention basins within the Sparks Community along the east side of the Sparks Arroyo. The proposed upper basin (Basin B) is

constructed by excavating a basin that is currently owned by the County to a capacity of approximately 8 acre-feet. In addition, concrete lined channels to the north and south of the basin are proposed to intercept flow from the community and divert it to the basin. The proposed lower basin is constructed by excavating approximately 13 acre-feet from an empty lot. In addition, concrete lined channels to the north and south of the basin are proposed to intercept flow from the community and divert it to the basin. The purpose of the improvements is to prevent additional flow and sediment from the Sparks Community from entering the Sparks Arroyo. These proposed improvements are shown on Figure 6-10.

6.3.1.7 Valley Ridge Basin (SSA7)

This project involves constructing a retention basin at the lower end of the Sparks Arroyo, downstream of Stockyard Drive. The proposed embankment is approximately 6 feet tall. The proposed basin is approximately 60 feet deep and requires approximately 684 acre-feet of excavation for flood and sediment pool storage. The purpose of the basin is to retain flows and sediment conveyed by the Sparks Arroyos before they reach the downstream residential and agricultural areas, while allowing the arroyo to maintain its natural course. In addition, the project involves constructing approximately 3,500 feet of concrete lined channel parallel to Stockyard Drive. The proposed channel has a bottom width of approximately 10 feet, 2 to 1 side slopes, and is approximately 5 feet deep. The purpose of the channel improvements is to capture and divert flows to the basin. The channel improvements require the replacement of three crossing structures. All three proposed structures consist of six 5-foot by 4-foot CBCs. A new crossing structure consisting of six 5-foot by 4-foot CBCs is also required as part of the improvements. These proposed improvements are shown on Figure 6-11.

6.4 Socorro Study Area

Flooding within the Socorro Study Area is largely a result of a lack of flood and sediment control structures along the natural arroyos. Large flows from the high mesa are uncontrolled and become loaded with sediment as they approach the valley below. When these flows reach the valley, they spread out and sheet flow, forming alluvial fans. To address these inadequacies in the current stormwater infrastructure, a series of projects was identified.

6.4.1 Specific Projects

6.4.1.1 El Paso Hills Basin Repair (SOC1)

This project involves repairing the existing basin embankment at the El Paso Hills Detention Basin. The basin embankment failed as a result of a large storm and has not been repaired. The proposed embankment cannot be constructed any higher than the existing embankment, as it would cause flooding of nearby residences, but some additional flood and sediment pool storage can be provided by excavation. Approximately 33 acre-feet of excavation is required for additional flood and sediment pool storage. The outlet structure for this basin consists of two 3-foot by 3-foot CBCs. The basin has two primary purposes:

1. Capture sediment being transported down the arroyos and reduce deposition in the downstream channels and floodplains; and
2. Detain the flood flows coming down the arroyos and release them slowly from the detention basin at a rate that will reduce flooding downstream.

These proposed improvements require that the basin be acquired by El Paso County before they can be made. These improvements are also predicated on the assumption that documents can be provided that demonstrate that the original embankment was properly engineered, constructed, and approved. These proposed improvements are shown on Figure 6-12.

6.4.1.2 Stream 4 Basin (SOC2)

This project involves constructing a detention basin at the lower end of Stream 4, below the El Paso Hills Detention Basin. The proposed embankment is approximately 30 feet tall and requires approximately 51 acre-feet of excavation for flood and sediment pool storage. The outlet structure for this basin consists of a 2-foot by 2-foot CBC. The basin has two primary purposes:

1. Capture sediment being transported down the arroyos and reduce deposition in the downstream channels and floodplains; and
2. Detain the flood flows coming down the arroyos and release them slowly from the detention basin at a rate that will reduce flooding downstream.

These proposed improvements are shown on Figure 6-13.

6.4.1.3 Stream 5 Basin (SOC3)

This project involves constructing a detention basin at the lower end of Stream 5. The proposed embankment is approximately 26 feet tall and requires approximately 8 acre-feet of excavation for flood and sediment pool storage. The outlet structure for this basin consists of a 2-foot by 2-foot CBC. The basin has two primary purposes:

1. Capture sediment being transported down the arroyos and reduce deposition in the downstream channels and floodplains; and
2. Detain the flood flows coming down the arroyos and release them slowly from the detention basin at a rate that will reduce flooding downstream.

These proposed improvements are shown on Figure 6-14.

6.4.1.4 Stream 5.5 Basin (SOC4)

This project involves constructing a detention basin at the lower end of Stream 5.5. The proposed embankment is approximately 29 feet tall and requires approximately 10 acre-feet of excavation for flood and sediment pool storage. The outlet structure for this basin consists of a 2-foot by 2-foot CBC. The basin has two primary purposes:

1. Capture sediment being transported down the arroyos and reduce deposition in the downstream channels and floodplains; and

2. Detain the flood flows coming down the arroyos and release them slowly from the detention basin at a rate that will reduce flooding downstream.

These proposed improvements are shown on Figure 6-15.

6.4.1.5 Carr Road Crossing (SOC5)

This project involves removing the existing 48-inch CMP culvert at the intersection of the Mesa Spur Drain and Carr Road and replacing it with two 7-foot by 7-foot CBCs. This culvert size provides capacity equal to or greater than that of the upstream channel. Although this crossing was not identified as a problem crossing by the County, this project was included because the existing culvert could restrict the flow of the channel if it were flowing bank-full. These proposed improvements are shown on Figure 6-16.

6.4.1.6 Coker Road Crossing (SOC6)

This project involves removing the existing 48-inch CMP culvert at the intersection of the Mesa Spur Drain and Coker Road and replacing it with two 7-foot by 7-foot CBCs. This culvert size provides capacity equal to or greater than that of the upstream channel. Although this crossing was not identified as a problem crossing by the County, this project was included because the existing culvert could restrict the flow of the channel if it were flowing bank-full. These proposed improvements are shown on Figure 6-16.

6.4.1.7 Anderson Road Crossing (SOC7)

This project involves removing the existing 48-inch CMP culvert at the intersection of the Mesa Spur Drain and Anderson Road and replacing it with two 7-foot by 7-foot CBCs. This culvert size provides capacity equal to or greater than that of the upstream channel. Although this crossing was not identified as a problem crossing by the County, this project was included because the existing culvert could restrict the flow of the channel if it were flowing bank-full. These proposed improvements are shown on Figure 6-17.

6.4.1.8 Mesa Drain Crossing (SOC8)

This project involves removing the existing 60-inch CMP culvert at the intersection of the Mesa Spur Drain and the Mesa Drain and replacing it with two 7-foot by 7-foot CBCs. This culvert size provides capacity equal to or greater than that of the upstream channel. Although this crossing was not identified as a problem crossing by the County, this project was included because the existing culvert could restrict the flow of the channel if it were flowing bank-full. These proposed improvements are shown on Figure 6-17.

6.5 Hacienda Real Study Area

Flooding within the Hacienda Real Study Area is largely a result of a lack of flood and sediment control structures along the natural arroyos. Additionally, several crossings in

the study area are undersized. To address these inadequacies in the current stormwater infrastructure, a series of projects was identified.

6.5.1 Specific Projects

6.5.1.1 Stream 6 Basin Outlet (HAC1)

This project involves installing a low flow principal outlet in the existing basin at the end of Stream 6 and a storm drain to direct the outlet flows to Stream 7. The basin currently captures flow from the arroyo, filling until its capacity is reached, then it overtops and flows down the streets of the surrounding community. This project provides the infrastructure to convey the flow to Stream 7, where it can be conveyed to a proposed basin (HAC2, Basin A) that is sized to handle flows from both arroyos. Although the existing basin is providing some benefit in its current state, it is not sized and cannot be expanded to such a size that will handle the 100-year flood flows from Stream 6. The proposed outlet structure consists of approximately 3,700 feet of 2-foot by 2-foot CBC. These proposed improvements are shown on Figure 6-18.

6.5.1.2 Stream 7 Basins (HAC2)

This project involves constructing two retention basins along Stream 7. The proposed upper basin (Basin B) controls flows from the upper end of the watershed, releasing a small amount of flow into Stream 7. The proposed embankment for Basin B is approximately 28 feet tall and requires approximately 101 acre-feet of excavation for flood and sediment pool storage. The outlet structure for the basin consists of a 2-foot by 2-foot CBC. The proposed lower basin (Basin A) controls the flows released from Basin B as well as the flows accumulating within the watershed below the upper basin. The proposed embankment for Basin A is approximately 16 feet tall and requires approximately 6 acre-feet of excavation for flood and sediment pool storage. The outlet structure for the basin consists of one 2-foot by 2-foot CBC. The basins have two primary purposes:

1. Capture sediment being transported down the arroyos and reduce deposition in the downstream channels and floodplains; and
2. Retain the flood flows coming down the arroyos and allow minimal releases.

These proposed improvements are shown on Figure 6-19.

6.5.1.3 Stream 8 Basin (HAC3)

This project involves constructing a retention basin at the lower end of Stream 8. The proposed embankment is approximately 6 feet tall and requires approximately 64 acre-feet of excavation for flood and sediment pool storage. The outlet structure for the basin consists of a 2-foot by 2-foot CBC. The basin has two primary purposes:

1. Capture sediment being transported down the arroyos and reduce deposition in the downstream channels and floodplains; and

2. Retain the flood flows coming down the arroyos and allow minimal releases.

These proposed improvements are shown on Figure 6-18.

6.5.1.4 Streams 9 and 10 Basin (HAC4)

This project involves constructing a retention basin at the lower end of Streams 9 and 10. The proposed embankment is approximately 6 feet tall and requires approximately 36 acre-feet of excavation for flood and sediment pool storage. The outlet structure for the basin consists of a 2-foot by 2-foot CBC. The basin has two primary purposes:

1. Capture sediment being transported down the arroyos and reduce deposition in the downstream channels and floodplains; and
2. Retain the flood flows coming down the arroyos and allow minimal releases.

These proposed improvements are shown on Figure 6-20.

6.5.1.5 Stream 11 Basin (HAC5)

This project involves constructing a retention basin at the lower end of Stream 11. The proposed embankment is approximately 6 feet tall and requires approximately 61 acre-feet of excavation for flood and sediment pool storage. The outlet structure for the basin consists of a 2-foot by 2-foot CBC. The basin has two primary purposes:

1. Capture sediment being transported down the arroyos and reduce deposition in the downstream channels and floodplains; and
2. Retain the flood flows coming down the arroyos and allow minimal releases.

These proposed improvements are shown on Figure 6-20.

6.5.1.6 Streams 12 and 13 Basin (HAC6)

This project involves constructing a retention basin below the convergence of Streams 12 and 13. The proposed embankment is approximately 6 feet tall and requires approximately 127 acre-feet of excavation for flood and sediment pool storage. The outlet structure for the basin consists of a 2-foot by 2-foot CBC. The basin has two primary purposes:

1. Capture sediment being transported down the arroyos and reduce deposition in the downstream channels and floodplains; and
2. Detain the flood flows coming down the arroyos and release them slowly from the detention basin at a rate that will reduce flooding downstream.

These proposed improvements are shown on Figure 6-21.

6.5.1.7 Stream 13.5 Basin (HAC7)

This project involves constructing two detention basins along Stream 13.5. The proposed upper basin (Basin B) controls flows from the upper end of the watershed, releasing a small amount of flow into Stream 13.5. The proposed embankment for Basin B is approximately 6 feet tall and requires approximately 13 acre-feet of excavation for flood and sediment pool storage. The outlet structure for the basin consists of a 2-foot by 2-foot CBC. The proposed lower basin (Basin A) controls the flows released from the Basin B as well as the flows accumulating within the watershed below the upper basin. The proposed embankment for Basin A is approximately 6 feet tall and requires approximately 3 acre-feet of excavation for flood and sediment pool storage. The outlet structure for the basin consists of two 4-foot by 4-foot CBCs. The basins have two primary purposes:

1. Capture sediment being transported down the arroyos and reduce deposition in the downstream channels and floodplains; and
2. Detain the flood flows coming down the arroyos and release them slowly from the detention basin at a rate that will reduce flooding downstream.

These proposed improvements are shown on Figure 6-21.

6.5.1.8 Bridgeway Drive Crossing (HAC8)

This alternative involves removing the existing five 48-inch CMP culverts at the intersection of Stream 7 and Bridgeway Drive and replacing them with five 4-foot by 4-foot CBCs. This culvert size provides sufficient capacity if additional storage is provided upstream per HAC2. These proposed improvements are shown on Figure 6-22.

6.5.1.9 North Loop Drive Crossing (HAC9)

This alternative involves removing the existing 60-inch RCP culvert at the intersection of the Mesa Drain and Northloop Drive and replacing it with three 4-foot by 4-foot CBCs. This culvert size provides capacity equal to or greater than that of the upstream channel. Although this crossing was not identified as a problem crossing by the County, this project was included because the existing culvert could restrict the flow of the channel if it were flowing bank-full. These proposed improvements are shown on Figure 6-22.

6.5.1.10 FM 1110 Crossing (HAC10)

This alternative involves removing the existing 42-inch CMP culvert at the intersection of the Mesa Drain and FM 1110 and replacing it with two 7-foot by 7-foot CBCs. This culvert size provides capacity slightly lower than that of channel immediately upstream, but provides the maximum opening allowable for crossing and channel geometry. The existing culvert is collapsed and was identified as a problem crossing. These proposed improvements are shown on Figure 6-22.

6.5.1.11 Salatral Lateral Crossing (HAC11)

This alternative involves removing the existing 36-inch RCP culvert at the intersection of the Mesa Drain and Salatral Lateral and replacing it with two 7-foot by 7-foot CBCs. This culvert size provides capacity equal to or greater than that of the upstream channel. Although this crossing was not identified as a problem crossing by the County, this project was included because the existing culvert could restrict the flow of the channel if it were flowing bank-full. These proposed improvements are shown on Figure 6-22.

6.5.1.12 Fenter Road Crossing (HAC12)

This alternative involves removing the existing 72-inch CMP culvert at the intersection of the Mesa Drain and Fenter Road and replacing it with two 7-foot by 7-foot CBCs. This culvert size provides capacity equal to or greater than that of the upstream channel. Although this crossing was not identified as a problem crossing by the County, this project was included because the existing culvert could restrict the flow of the channel if it were flowing bank-full. These proposed improvements are shown on Figure 6-22.

6.5.1.13 Dirt Road Upstream of Celum Road Crossing (HAC13)

This alternative involves removing the existing 54-inch CMP culvert at the intersection of the Mesa Drain and the dirt road just upstream of Celum Road and replacing it with two 7-foot by 7-foot CBCs. This culvert size provides capacity slightly lower than that of channel immediately upstream, but provides the maximum opening allowable for crossing and channel geometry. Although this crossing was not identified as a problem crossing by the County, this project was included because the existing culvert could restrict the flow of the channel if it were flowing bank-full. These proposed improvements are shown on Figure 6-22.

6.5.1.14 Celum Road Crossing (HAC14)

This alternative involves removing the existing 36-inch CMP culvert at the intersection of the Mesa Drain and Celum Road and replacing it with two 7-foot by 7-foot CBCs. This culvert size provides capacity equal to or greater than that of the upstream channel. Although this crossing was not identified as a problem crossing by the County, this project was included because the existing culvert could restrict the flow of the channel if it were flowing bank-full. These proposed improvements are shown on Figure 6-22.

6.6 Fabens Study Area

The issues of concern within the Fabens Study Area are largely due to the lack of access to the drainage facilities along the arroyos. Additionally, the capacity of flood and sediment control structures is inadequate. To address these inadequacies in the current stormwater facilities, a series of projects was identified.

6.6.1 Specific Projects

6.6.1.1 Fabens North 1 Basin (FAB1)

This project involves repairing the existing basin embankment at the downstream end of Fabens North 1 Arroyo, where the existing basin is currently located, and acquiring ROW property on which the basin lies. The basin embankment failed as a result of a large storm event and has not been repaired because the County does not currently have ownership of the basin. The property acquisition will allow the County to repair and maintain the basin as needed. The basin embankment failed as a result of a large storm event and has not been repaired due to ownership issues. The proposed embankment is approximately 15 feet tall and requires approximately 27 acre-feet of excavation for flood and sediment pool storage. The outlet structure for this basin consists of a 2-foot by 2-foot CBC. The basin has two primary purposes:

1. Capture sediment being transported down the arroyos and reduce deposition in the downstream channels and floodplains; and
2. Detain the flood flows coming down the arroyos and release them slowly from the detention basin at a rate that will reduce flooding downstream.

These proposed improvements are shown on Figure 6-23.

6.6.1.2 San Felipe Arroyo (FAB2)

This project involves acquiring ROW property along the channel within the residential area. The channel currently has no identified capacity issues at this time. This project is a preventative measure to ensure the channel continues to function without significant issues, by providing the County with necessary access to continue to maintain the channel and protect the residents of Fabens. This proposed improvement is shown on Figure 6-23.

6.6.1.3 Fabens Dam (FAB3)

Fabens Dam is the only TCEQ regulated dam owned by the County. TCEQ regulations require that a dam of this size pass 75% of the PMP event without overtopping and potentially breaching the dam. The PMP is much larger than the 100-year storm event and is intended to ensure protection of downstream residents during the most severe storm events. This project consists of constructing approximately 1,165 feet of 4-foot-high concrete parapet wall along the crest of the current dam embankment. In addition, it is required that the east auxiliary spillway be widened 100 feet to a total width of approximately 150 feet. With these improvements, the dam should be able to safely pass the regulatory flood. These proposed improvements are shown in Figure 6-24.

6.7 Tornillo Study Area

Flooding within the Tornillo Study Area is largely a result of a lack of flood and sediment control structures along the natural arroyos. Large flows upstream of the town of Tornillo become loaded with sediment as they approach the town. When these flows from the steep arroyo meet the flatter terrain of the urban area, the sediment is

deposited. The arroyo lacks a defined channel in this area of deposition and flood flows are uncontrolled and may cause damage. To address these inadequacies in the current stormwater facilities, a series of projects was identified.

6.7.1 Specific Projects

6.7.1.1 High School Channel (TOR1)

This project involves constructing a retention basin (Basin B) on currently vacant land southeast of the high school at the end of High School Channel, South High School Channel, and Flow Path T. The project consists of improving and extending the existing embankment to catch flow conveyed through all three channels. The proposed embankment is approximately 6 feet tall. The proposed basin is approximately 4 feet deep and requires approximately 49 acre-feet of excavation for flood and sediment pool storage. The outlet structure for this basin consists of a 2-foot by 2-foot CBC. The purpose of the basin is to retain flows and sediment conveyed by the three channels mentioned above and release them at a controlled rate. Additionally, the project involves constructing a sediment basin (Basin A) upstream on High School Channel at the convergence of High School Channel and High School Channel Trib. 1. This proposed sediment basin is approximately 3-feet deep and requires approximately 4 acre-feet of excavation for sediment pool storage. This sediment basin will assist the lower flood control basin at the bottom of the channel by reducing the sediment load reaching the lower basin. These proposed improvements are shown on Figure 6-25.

6.7.1.2 High School Channel Embankment (TOR2)

This project involves improving the west bank of the diversion channel northeast of the high school. The channel bank improvement consists of 2,030 feet of 5 to 1 side slope riprap reinforcement along the west bank of the existing channel. Channel configuration is not expected to change. The proposed improvements are shown on Figure 6-25.

6.7.1.3 Flow Path T (TOR3)

The project involves constructing a sediment basin upstream on Flow Path T, just upstream of IH-10. The proposed sediment basin is approximately 2-feet deep and requires approximately 2 acre-feet of excavation for sediment pool storage. This sediment basin will assist the lower flood control basin at the bottom of the channel by reducing the sediment load reaching the lower basin. The proposed basin does not require an embankment. These proposed improvements are shown on Figure 6-25.

If the retention basin (Basin B) discussed in TOR1 has not been constructed prior to this project, it should be constructed as part of this project.

6.7.1.4 Tornillo Handle Channel 2 (TOR4)

This project involves constructing a retention basin on currently vacant land at the confluence of Tornillo Handle Channel 1 and Tornillo Handle Channel 2. The proposed embankment is approximately 10 feet tall. The proposed basin requires approximately 7 acre-feet of excavation for flood and sediment pool storage. The outlet structure for

this basin consists of a 2-foot by 2-foot CBC. The purpose of the basin is to retain flows and sediment conveyed by the Tornillo Handle Channel 1 and Tornillo Handle Channel 2 and release them at a controlled rate. These proposed improvements are shown on Figure 6-26.

6.7.1.5 Tornillo Handle Channel 1 (TOR5)

This project involves the improvement of the existing embankment of the south bank of Tornillo Handle Channel 1. The project does not include any change to the configuration of the channel. The channel bank improvement consists of 1,650 feet of 3 to 1 side slope riprap reinforcement along the south bank. If the retention basin discussed in TOR4 has not been constructed prior to this project, it should be constructed as part of this project. These proposed improvements are shown on Figure 6-26.

6.7.1.6 OT Smith Road Crossing (TOR6)

This project involves replacing the existing two 36-inch pipes at the intersection of Tornillo Handle Channel 2 and OT Smith Road with two 4-foot by 2-foot CBCs. This culvert size will provide sufficient capacity for the 100-year flood to be conveyed through the crossing. This proposed improvement is shown on Figure 6-26.

6.8 Summary

Table 6-1 shows a summary of all the selected projects and their estimated costs. Detailed cost estimates are included in Appendix C.

Table 6-1. Stormwater Projects

Study Area	Project No.	Issue to be addressed	Description of Improvements	Total Cost
Vinton	VIN1*	Flooding along channel due to uncontrolled flows from Flow Path Number 45A and Flow Path Number 45.	This project involves constructing a diversion channel upstream of Remington Drive directing the flow to Flow Path Number 45, and two combination sediment/detention basins. One basin on the north portion of the upper watershed (Basin A) and the other on the south portion of the upper watershed (Basin B). Basin A will be 24 feet high. Approximately 380 acre-feet of excavation will be required for flood and sediment pool storage. A principal outlet and an earthen auxiliary spillway will be included in the design. Basin B will be 23 feet high. Approximately 200 acre-feet of excavation will be required for flood and sediment pool storage. A principal outlet and an earthen auxiliary spillway will be included in the design.	\$21,810,000
Vinton	VIN2*	Area flooding due to uncontrolled flows from Flow Path Number 45A.	This project involves increasing 950 feet of the lower portion of Flow Path Number 45A channel capacity from 240 feet upstream of Iron Drive to 260 feet downstream of Kiely Road.	\$240,000
Vinton	VIN3*	Area flooding due to uncontrolled flows from Flow Path Number 45.	This project involves increasing 1,600 feet of the upper portion of Flow Path Number 45 channel capacity to convey the outflow of the basins associated with VIN1*. The effectiveness of VIN3* is dependent on VIN1* being constructed.	\$120,000
Vinton	VIN4*	Area flooding due to uncontrolled flows from Flow Path Number 45.	This project involves increasing 4,500 feet of the middle portion of Flow Path Number 45 channel capacity to convey the outflow of the basins associated with VIN1*.	\$860,000
Vinton	VIN7*	Crossing capacity at Railroad and Flow Path Number 45 is less than the necessary capacity.	This project involves expanding the existing bridge to cross the improved channel. This will provide sufficient capacity equal to the channel improvements.	\$620,000
Vinton	VIN8*	Crossing capacity at Doniphan Drive and Flow Path Number 45 is less than the necessary capacity.	This project involves removing the existing two 6-foot by 6-foot culverts and replacing it with a bridge. This will provide sufficient capacity equal to the upstream channel.	\$1,260,000
Vinton	VIN9*	Crossing capacity at AP Ramirez and Flow Path Number 45 is less than the necessary capacity.	This project involves removing the existing four 36-inch culverts and replacing it with a bridge. This will provide sufficient capacity equal to the upstream channel.	\$1,410,000
Vinton	VIN10*	Crossing capacity at Kiely Road and Flow Path Number 45 is less than the necessary capacity.	This project involves removing the existing two 8-foot by 3-foot culverts and replacing it with a bridge. This will provide sufficient capacity equal to the upstream channel.	\$730,000
Vinton	VIN11*	Crossing capacity at Quejette Drive and Flow Path Number 45 is less than the necessary capacity.	This project involves removing the at grade crossing and replacing it with a bridge. This will provide sufficient capacity equal to the upstream channel.	\$700,000
Vinton	VIN12*	Crossing capacity at IH-10 Northbound off-ramp and Flow Path Number 45 is less than the necessary capacity.	This project involves adding three more 9-foot by 5-foot culverts to the existing battery of culverts. This addition of culverts provides sufficient capacity equal to the upstream channel.	\$200,000
Vinton	VIN13*	Crossing capacity at Kiely Road and Flow Path Number 45A is less than the necessary capacity.	This project involves removing the existing two 30-inch round concrete pipes and replacing it with five 7-foot by 4-foot culverts. This culvert size provides sufficient capacity equal to the upstream channel.	\$260,000
Vinton	VIN14*	Crossing capacity at Iron Drive and Flow Path Number 45A is less than the necessary capacity.	This project involves removing the existing three 30-inch round concrete pipes and replacing them with six 6-foot by 6-foot culverts. This culvert size provides sufficient capacity equal to the upstream channel.	\$310,000

Table 6-1. Stormwater Projects (Continued)

Study Area	Project No.	Issue to be addressed	Description of Improvements	Total Cost
Vinton	VIN5	Downstream flooding due to uncontrolled flows from Flow Path Number 44.	This project involves increasing 2,054 feet of Flow Path Number 44 channel capacity to convey the 100-year flood.	\$860,000
Vinton	VIN6	Crossing capacity at Doniphan Drive and Flow Path Number 44 is less than the necessary capacity.	This project involves removing the existing 16-foot by 5-foot culvert and replacing it with three 9-foot by 8-foot culverts. This culvert size provides sufficient capacity equal to the upstream channel.	\$600,000
Canutillo	CAN1	Downstream flooding and sediment load due to uncontrolled flows from Flow Path Number 42 and lack of maintenance of channel due to ROW issues.	This project involves reconstructing the channel to convey the 100-year flood, with a concrete lining. Additionally, properties that extend into the channel will need to be acquired.	\$1,440,000
Canutillo	CAN2	Localized flooding due to lack of flood control structures.	This project involves constructing two retention basins and utilizing an existing basin. One of the constructed basins (Basin B) will be located at the downstream end of First Avenue Channel and the second (Basin A) in a vacant area east of the intersection of West Avenue and Third Avenue. Basin B will not require an embankment. Approximately 11 acre-feet of excavation will be required for flood pool storage. Basin A will be 6 feet high and will have a clay core, a polyurethane liner, a chimney drain, and will have 18-inch riprap on the interior face. Approximately 21 acre-feet of excavation will be required for flood pool storage, of which a portion will be covered with a clay blanket. A low flow principal spillway will be included to convey flow as Basin A reaches capacity. Additionally, improvements will be made to First Avenue Channel.	\$4,360,000
Canutillo	CAN3	Crossing capacity at Doniphan Drive and First Avenue Channel is less than the necessary capacity.	This project involves removing the existing two 6-foot by 3-foot culvert and replacing it with the same size culvert, ensuring the culvert in sloping in the correct direction to drain. This culvert size provides sufficient capacity provided that additional storage is provided upstream per CAN2.	\$140,000
Sparks Arroyo and Sub Basin A	SSA1	Uncontrolled flows from Arroyos A1, A2, and A3 are causing flooding problems in downstream communities.	This project involves constructing a detention basin that will capture flow from Arroyos A1, A2, and A3. The basin will be 41 feet high and will have a clay core, a polyurethane liner, a chimney drain, and will have 18-inch riprap on the interior face. Embankment height includes 10 feet of freeboard for PMP event. Approximately 306 acre-feet of excavation will be required for flood pool storage, of which a portion will be covered with a clay blanket. Approximately 1,041 acre-feet of flood and sediment pool storage will be provided by this basin.	\$22,630,000
Sparks Arroyo and Sub Basin A	SSA2	Uncontrolled flows from Arroyo A4 are causing flooding problems in downstream communities.	This project involves constructing a detention basin that will capture flow from Arroyo A4. The basin will be 22 feet high and will have a clay core, a polyurethane liner, a chimney drain, and will have 18-inch riprap on the interior face. Embankment height includes 6 feet of freeboard for PMP event. Approximately 46 acre-feet of excavation will be required for flood pool storage, of which a portion will be covered with a clay blanket. Approximately 121 acre-feet of flood and sediment pool storage will be provided by this basin.	\$4,360,000

Table 6-1. Stormwater Projects (Continued)

Study Area	Project No.	Issue to be addressed	Description of Improvements	Total Cost
Sparks Arroyo and Sub Basin A	SSA3	Uncontrolled flows from Arroyos A5 and A6 are causing flooding problems in downstream communities.	This project involves constructing a detention basin that will capture flow from Arroyos A5 and A6. The basin will be 36 feet high and will have a clay core, a polyurethane liner, a chimney drain, and will have 18-inch riprap on the interior face. Embankment height includes 7 feet of freeboard for PMP event. Approximately 67 acre-feet of excavation will be required for flood pool storage, of which a portion will be covered with a clay blanket. Approximately 171 acre-feet of flood and sediment pool storage will be provided by this basin. 1,100 feet of Arroyo A5 will be reshaped and lined to divert flow to the basin as part of this improvement.	\$6,170,000
Sparks Arroyo and Sub Basin A	SSA4	Flows entering the Sparks Arroyo from the upstream mesa are creating capacity issues for the arroyo and flooding problems downstream.	This project involves constructing a detention basin that will capture flow from the mesa above Sparks Arroyo. The basin will be 37 feet high and will have a clay core, a polyurethane liner, a chimney drain, and will have 18-inch riprap on the interior face. Embankment height includes 10 feet of freeboard for PMP event. Approximately 139 acre-feet of excavation will be required for flood pool storage, of which a portion will be covered with a clay blanket. Approximately 639 acre-feet of flood and sediment pool storage will be provided by this basin.	\$11,600,000
Sparks Arroyo and Sub Basin A	SSA5	The Sparks Arroyo is currently experiencing erosion along its banks.	This project involves defining the Sparks Arroyo and lining it with concrete to prevent further erosion and add capacity. Approximately 10,300 feet of channel improvements. In addition, a crossing will need to be constructed under Stockyard Drive.	\$8,690,000
Sparks Arroyo and Sub Basin A	SSA6	Runoff from the Sparks Community is contributing to flooding problems downstream of the Sparks Arroyo.	This project involves constructing two retention basins within the Sparks Community west of the Sparks Arroyo. The north basin will need to be excavated to a volume of approximately 8 acre-feet and will have a 940-foot long concrete lined channel diverting water to it from the north and a 390-foot concrete lined channel from the south. The south basin will need to be excavated to a volume of approximately 13 acre-feet and will have a 980-foot long concrete lined channel diverting water to it from the north and a 250-foot concrete lined channel from the south.	\$1,910,000
Sparks Arroyo and Sub Basin A	SSA7	Uncontrolled flows from the Sparks Arroyo are causing flooding problems in downstream communities.	This project involves constructing a 684 acre-foot retention basin south of Stockyard Drive, at the mouth of the Sparks Arroyo. The basin will be approximately 54 feet deep and will have a 6-foot embankment that will have a clay core, a polyurethane liner, a chimney drain, and will have 18-inch riprap on the interior face. In addition, the existing channel along Stockyard Drive will be expanded, lined with concrete, and redirected to the proposed Valley Ridge Basin. The entire length of the channel improvements is 3,500 feet. The three existing crossings along this channel will need to be installed and one new crossing will need to be constructed.	\$20,300,000
Socorro	SOC1	Downstream flooding and sediment load due to uncontrolled flows from Stream 4 passing through the breached El Paso Hills Dam.	This project involves repairing the existing 15-foot-high embankment, adding 18-inch riprap to the interior embankment, adding principal and auxiliary spillways, and excavating approximately 33 acre-feet from the basin to provide flood and sediment pool storage.	\$1,240,000

Table 6-1. Stormwater Projects (Continued)

Study Area	Project No.	Issue to be addressed	Description of Improvements	Total Cost
Socorro	SOC2	Downstream flooding and sediment load due to uncontrolled flows from Stream 4.	This project involves constructing a combination sediment/detention basin at the base of Stream 4, downstream of SOC1. The basin embankment will be 30 feet high and will have a clay core, a polyurethane liner, a chimney drain, and will have 18-inch riprap on the interior face. Embankment height includes 5 feet of freeboard for PMP event. Approximately 51 acre-feet of excavation will be required for flood and sediment pool storage, of which a portion will be covered with a clay blanket. A box culvert principal outlet and an earthen auxiliary spillway will be included in the design.	\$2,400,000
Socorro	SOC3	Downstream flooding and sediment load due to uncontrolled flows from Stream 5.	This project involves constructing a combination sediment/detention basin at the base of Stream 5. The basin embankment will be 26 feet high and will have a clay core, a polyurethane liner, a chimney drain, and will have 18-inch riprap on the interior face. Embankment height includes 5 feet of freeboard for PMP event. Approximately 8 acre-feet of excavation will be required for flood and sediment pool storage, of which a portion will be covered with a clay blanket. A box culvert principal outlet and an earthen auxiliary spillway will be included in the design.	\$870,000
Socorro	SOC4	Downstream flooding and sediment load due to uncontrolled flows from Stream 5.5.	This project involves constructing a combination sediment/detention basin at the base of Stream 5.5. The basin embankment will be 29 feet high and will have a clay core, a polyurethane liner, a chimney drain, and will have 18-inch riprap on the interior face. Embankment height includes 5 feet of freeboard for PMP event. Approximately 10 acre-feet of excavation will be required for flood and sediment pool storage, of which a portion will be covered with a clay blanket. A box culvert principal outlet and an earthen auxiliary spillway will be included in the design.	\$1,180,000
Socorro	SOC5	Crossing capacity at Carr Road and Mesa Spur Drain is less than capacity of channel immediately upstream of crossing.	This project involves removing the existing 48-inch CMP culvert and replacing it with two 7-foot by 7-foot CBCs. This culvert size provides capacity equal to or greater than that of the upstream channel.	\$170,000
Socorro	SOC6	Crossing capacity at Coker Road and Mesa Spur Drain is less than capacity of channel immediately upstream of crossing.	This project involves removing the existing 48-inch CMP culvert and replacing it with two 7-foot by 7-foot CBCs. This culvert size provides capacity equal to or greater than that of the upstream channel.	\$140,000
Socorro	SOC7	Crossing capacity at Anderson Road and Mesa Spur Drain is less than capacity of channel immediately upstream of crossing.	This project involves removing the existing 48-inch CMP culvert and replacing it with two 7-foot by 7-foot CBCs. This culvert size provides capacity equal to or greater than that of the upstream channel.	\$160,000
Socorro	SOC8	Crossing capacity at Carr Road and Mesa Spur Drain is less than capacity of channel immediately upstream of crossing.	This project involves removing the existing 60-inch CMP culvert and replacing it with two 7-foot by 7-foot CBCs. This culvert size provides capacity equal to or greater than that of the upstream channel.	\$220,000
Hacienda Real	HAC1	Downstream flooding and sediment load due to uncontrolled flows from Stream 6. No low-level outlet in existing flood retention pond.	This project involves installing a low flow principal spillway in the existing basin. Additionally, parcels that extend into the basin will need to be acquired.	\$750,000

Table 6-1. Stormwater Projects (Continued)

Study Area	Project No.	Issue to be addressed	Description of Improvements	Total Cost
Hacienda Real	HAC2	Downstream flooding and sediment load due to uncontrolled flows from Stream 7.	This project involves constructing two combination sediment/detention basins on Stream 7, one in the upper watershed (Basin B), and one at the downstream end of Stream 7 (Basin A). Basin A will be 16 feet high and will have a clay core, a polyurethane liner, a chimney drain, and will have 18-inch riprap on the interior face. Embankment height includes 5 feet of freeboard for PMP event. Approximately 6 acre-feet of excavation will be required for flood and sediment pool storage, of which a portion will be covered with a clay blanket. A box culvert principal outlet and an earthen auxiliary spillway will be included in the design. Basin B will be 28 feet high and will have a clay core, a polyurethane liner, a chimney drain, and will have 18-inch riprap on the interior face. Embankment height includes 5 feet of freeboard for PMP event. Approximately 101 acre-feet of excavation will be required for flood and sediment pool storage, of which a portion will be covered with a clay blanket. A box culvert principal outlet and an earthen auxiliary spillway will be included in the design.	\$10,570,000
Hacienda Real	HAC8	Crossing capacity at Bridgeway Drive and Stream 7 is less than 100-year flood and has a history of sediment and washout issues.	This project involves removing the existing five 48-inch CMP culverts and replacing it with five 4-foot by 4-foot CBCs. This culvert size provides sufficient capacity provided that additional storage is provided upstream per HAC2.	\$460,000
Hacienda Real	HAC3	Downstream flooding and sediment load due to uncontrolled flows from Stream 8.	This project involves constructing a combination sediment/retention basin at the base of Stream 8. The basin embankment will be 6 feet high and will have a clay core, a polyurethane liner, a chimney drain, and will have 18-inch riprap on the interior face. Approximately 64 acre-feet of excavation will be required for flood and sediment pool storage.	\$2,160,000
Hacienda Real	HAC4	Downstream flooding and sediment load due to uncontrolled flows from Streams 9 and 10.	This project involves constructing a combination sediment/retention basin at the base of Streams 9 and 10. The basin embankment will be 6 feet high and will have a clay core, a polyurethane liner, a chimney drain, and will have 18-inch riprap on the interior face. Approximately 36 acre-feet of excavation will be required for flood and sediment pool storage.	\$1,510,000
Hacienda Real	HAC5	Downstream flooding and sediment load due to uncontrolled flows from Stream 11.	This project involves constructing a combination sediment/retention basin at the base of Stream 11. The basin embankment will be 6 feet high and will have a clay core, a polyurethane liner, a chimney drain, and will have 18-inch riprap on the interior face. Approximately 61 acre-feet of excavation will be required for flood and sediment pool storage.	\$2,340,000
Hacienda Real	HAC6	Downstream flooding and sediment load due to uncontrolled flows from Streams 12 and 13.	This project involves constructing a combination sediment/retention basin at the base of Streams 12 and 13. The basin embankment will be 6 feet high and will have a clay core, a polyurethane liner, a chimney drain, and will have 18-inch riprap on the interior face. Approximately 127 acre-feet of excavation will be required for flood and sediment pool storage.	\$3,550,000

Table 6-1. Stormwater Projects (Continued)

Study Area	Project No.	Issue to be addressed	Description of Improvements	Total Cost
Hacienda Real	HAC7	Downstream flooding and sediment load due to uncontrolled flows from Stream 13.5.	This project involves constructing two combination sediment/detention basins on Stream 13.5, one in the upper watershed (Basin B), and one at the downstream end of Stream 13.5 (Basin A). Basin A embankment will be 6 feet high and will have a clay core, a polyurethane liner, a chimney drain, and will have 18-inch riprap on the interior face. Embankment height includes 5 feet of freeboard for PMP event. Approximately 3 acre-feet of excavation will be required for flood and sediment pool storage, of which a portion will be covered with a clay blanket. A box culvert principal outlet and an earthen auxiliary spillway will be included in the design. Basin B embankment will be 6 feet high and will have a clay core, a polyurethane liner, a chimney drain, and will have 18-inch riprap on the interior face. Embankment height includes 5 feet of freeboard for PMP event. Approximately 13 acre-feet of excavation will be required for flood and sediment pool storage, of which a portion will be covered with a clay blanket. A box culvert principal outlet and an earthen auxiliary spillway will be included in the design.	\$2,710,000
Hacienda Real	HAC9	Crossing capacity at Northloop Drive and Mesa Drain is less than capacity of channel immediately upstream of crossing.	This project involves removing the existing 60-inch RCP culvert and replacing it with three 4-foot by 4-foot CBCs. This culvert size provides capacity equal to or greater than that of the upstream channel.	\$130,000
Hacienda Real	HAC10	Crossing capacity at FM 1110 and Mesa Drain is less than capacity of channel immediately upstream of crossing. Crossing is silted in and collapsed.	This project involves removing the existing 42-inch CMP culvert and replacing it with two 7-foot by 7-foot CBCs. This culvert size provides capacity slightly lower than that of channel immediately upstream, but provides maximum opening allowable for crossing and channel geometry.	\$520,000
Hacienda Real	HAC11	Crossing capacity at Salatral Lateral and Mesa Drain is less than capacity of channel immediately upstream of crossing.	This project involves removing the existing 36-inch RCP culvert and replacing it with two 7-foot by 7-foot CBCs. This culvert size provides capacity equal to or greater than that of the upstream channel.	\$500,000
Hacienda Real	HAC12	Crossing capacity at Fenter Road and Mesa Drain is less than capacity/crossing size of upstream improved crossings.	This project involves removing the existing 72-inch CMP culvert and replacing it with two 7-foot by 7-foot CBCs. This culvert size provides capacity equal to or greater than that of the upstream channel.	\$550,000
Hacienda Real	HAC13	Crossing capacity at dirt crossing upstream of Celum Road and Mesa Drain is less than capacity of channel immediately upstream of crossing.	This project involves removing the existing 54-inch CMP culvert and replacing it with two 7-foot by 7-foot CBCs. This culvert size provides capacity slightly lower than that of channel immediately upstream, but provides maximum opening allowable for crossing and channel geometry.	\$230,000
Hacienda Real	HAC14	Crossing capacity at Celum Road and Mesa Drain is less than capacity of channel immediately upstream of crossing.	This project involves removing the existing 36-inch CMP culvert and replacing it with two 7-foot by 7-foot CBCs. This culvert size provides capacity equal to or greater than that of the upstream channel.	\$250,000

Table 6-1. Stormwater Projects (Continued)

Study Area	Project No.	Issue to be addressed	Description of Improvements	Total Cost
Fabens	FAB1	Downstream flooding and sediment load due to uncontrolled flows from Fabens North 1.	This project involves constructing a combination sediment/retention basin at the base of Fabens North 1. The basin embankment will be 15 feet high and will have a clay core, a polyurethane liner, a chimney drain, and will have 18-inch riprap on the interior face. Embankment height includes 5 feet of freeboard for PMP event. Approximately 27 acre-feet of excavation will be required for flood and sediment pool storage, of which a portion will be covered with a clay blanket. A box culvert principal outlet and an earthen auxiliary spillway will be included in the design.	\$2,540,000
Fabens	FAB2	Lack of ROW acquisition along San Felipe Arroyo to maintain channel capacity.	This project involves obtaining property along San Felipe Arroyo to maintain channel capacity.	\$500,000
Fabens	FAB3	Dam will not pass 75% PMP.	This project involves constructing 1,165 feet of 4-foot-high parapet wall along the crest of Fabens Dam. In addition, the east auxiliary spillway will be widened 100 feet to a total width of 150 feet.	\$1,340,000
Tornillo	TOR1	Downstream flooding and sediment load due to uncontrolled flows from High School Channel and South High School Channel.	This project involves constructing a combination sediment/retention basin at the base of the confluence of High School Channel and South High School Channel (Basin B) and a sediment basin in the upper watershed (Basin A). Basin B will be 6 feet high and will have a clay core, a polyurethane liner, a chimney drain, and will have 18-inch riprap on the interior face. Approximately 49 acre-feet of excavation will be required for flood and sediment pool storage, of which a portion will be covered with a clay blanket. A box culvert principal outlet and an earthen auxiliary spillway will be included in the design. Basin A will be for sediment pool storage only, no embankment required. Approximately 4 acre-feet of excavation will be required for sediment pool storage.	\$2,430,000
Tornillo	TOR2	Erosion of West Bank along the redirected portion of High School Channel.	This project involves riprap reinforcement along the west bank of High School Channel.	\$810,000
Tornillo	TOR3	Downstream flooding and sediment load due to uncontrolled flows from Flow Path T.	This project involves the utilization of the construction of the combination sediment/retention basin (TOR1, Basin B) addressing issues for TOR1 and the construction of a sediment basin in the upper watershed (TOR3). TOR1, Basin B must be constructed in order for this project to address the flooding issue associated with Flow Path T. The sediment basin TOR3 will be for sediment pool storage only, no embankment required. Approximately 2 acre-feet of excavation will be required for sediment pool storage.	\$50,000
Tornillo	TOR4	Downstream flooding and sediment load due to uncontrolled flows from Tornillo Handle Channel 1 and Tornillo Handle Channel 2.	This project involves constructing a combination sediment/retention basin at the confluence of Tornillo Handle Channel 1 with Tornillo Handle Channel 2. The basin embankment will be 10 feet high and will have a clay core, a polyurethane liner, a chimney drain, and will have 18-inch riprap on the interior face. Embankment height includes 5 feet of freeboard for PMP event. Approximately 7 acre-feet of excavation will be required for flood and sediment pool storage, of which a portion will be covered with a clay blanket. A box culvert principal outlet and an earthen auxiliary spillway will be included in the design.	\$1,340,000

Table 6-1. Stormwater Projects (Continued)

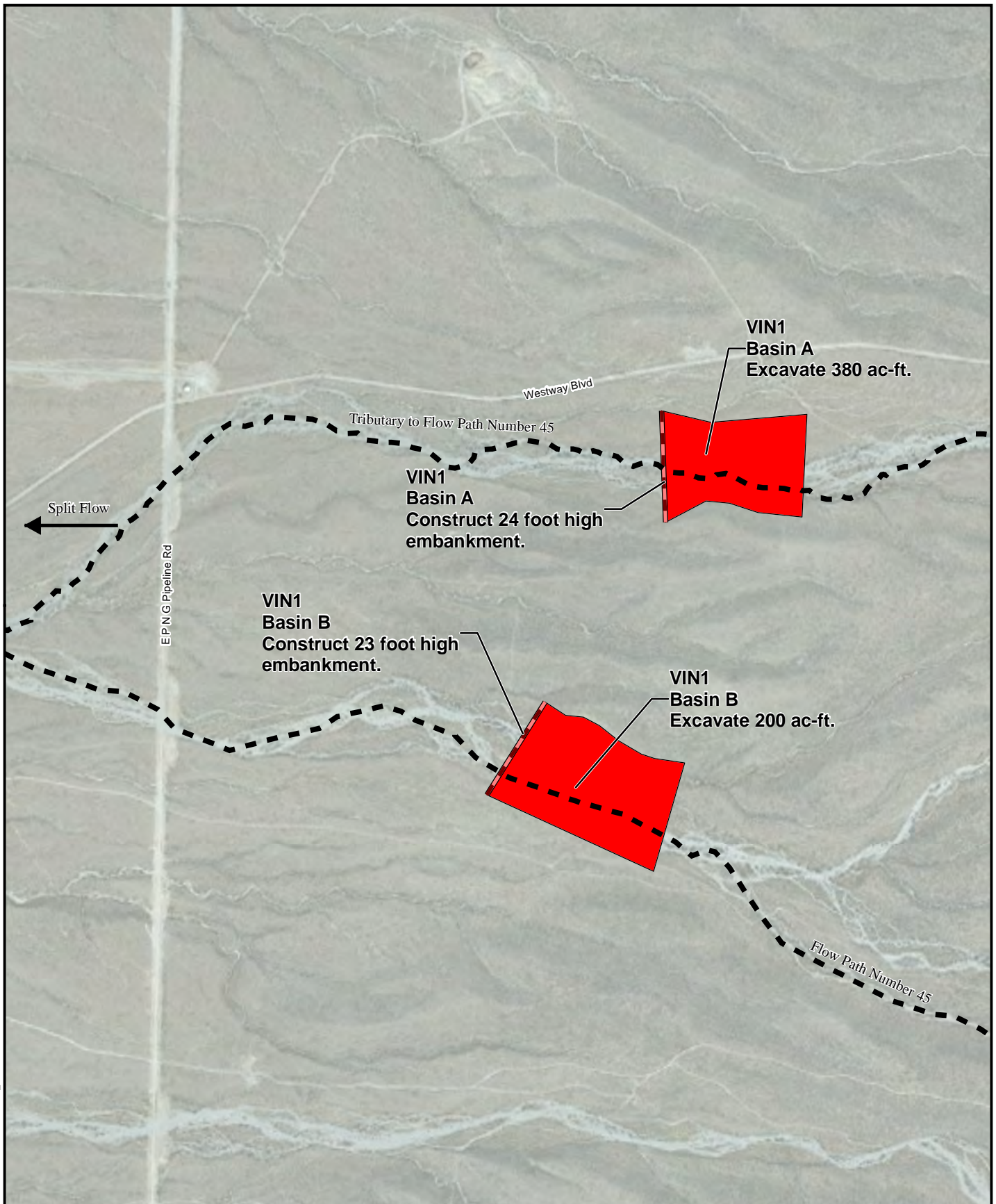

Study Area	Project No.	Issue to be addressed	Description of Improvements	Total Cost
Tornillo	TOR5	Downstream flooding due to uncontrolled flows from Tornillo Handle Channel 1.	This project involves riprap reinforcement along the south bank of Tornillo Handle Channel 1.	\$210,000
Tornillo	TOR6	Crossing capacity at OT Smith Road and Tornillo Handle Channel 2 is less than the necessary capacity.	This project involves removing the existing two 36-inch by 19-inch arch culvert and replacing it with two 4-foot by 2-foot CBCs. This culvert size provides sufficient capacity equal to that of the upstream channel.	\$50,000

*Issues, alternatives and cost identified in the City of El Paso Stormwater Master Plan (SMP).



0 500 1,000
 Feet
 1 : 12,000 or 1 inch = 1,000 Feet

Legend

-  Existing Channel
- Recommended Improvements*
-  Embankment
-  Proposed Basin

**Vinton Study Area
 VIN1**

El Paso County
 Stormwater Master Plan

August 2010

Figure 6-1





VIN1
Construct 2,240 feet of earthen diversion channel to Flow Path Number 45.

VIN12
Add 3-9x5 CBCs to existing culverts at the intersection of Flow Path Number 45 and IH-10 northbound off-ramp.

VIN3
Construct 1,600 feet of earthen channel.

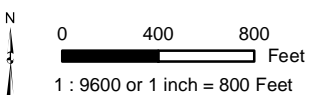

- Legend**
- Existing Channel
 - Recommended Improvements
 - Proposed Channel Solution
 - ✘ Undersized Crossing

Vinton Study Area
VIN1, VIN3, and VIN12
El Paso County
Stormwater Master Plan

August 2010

Figure 6-2



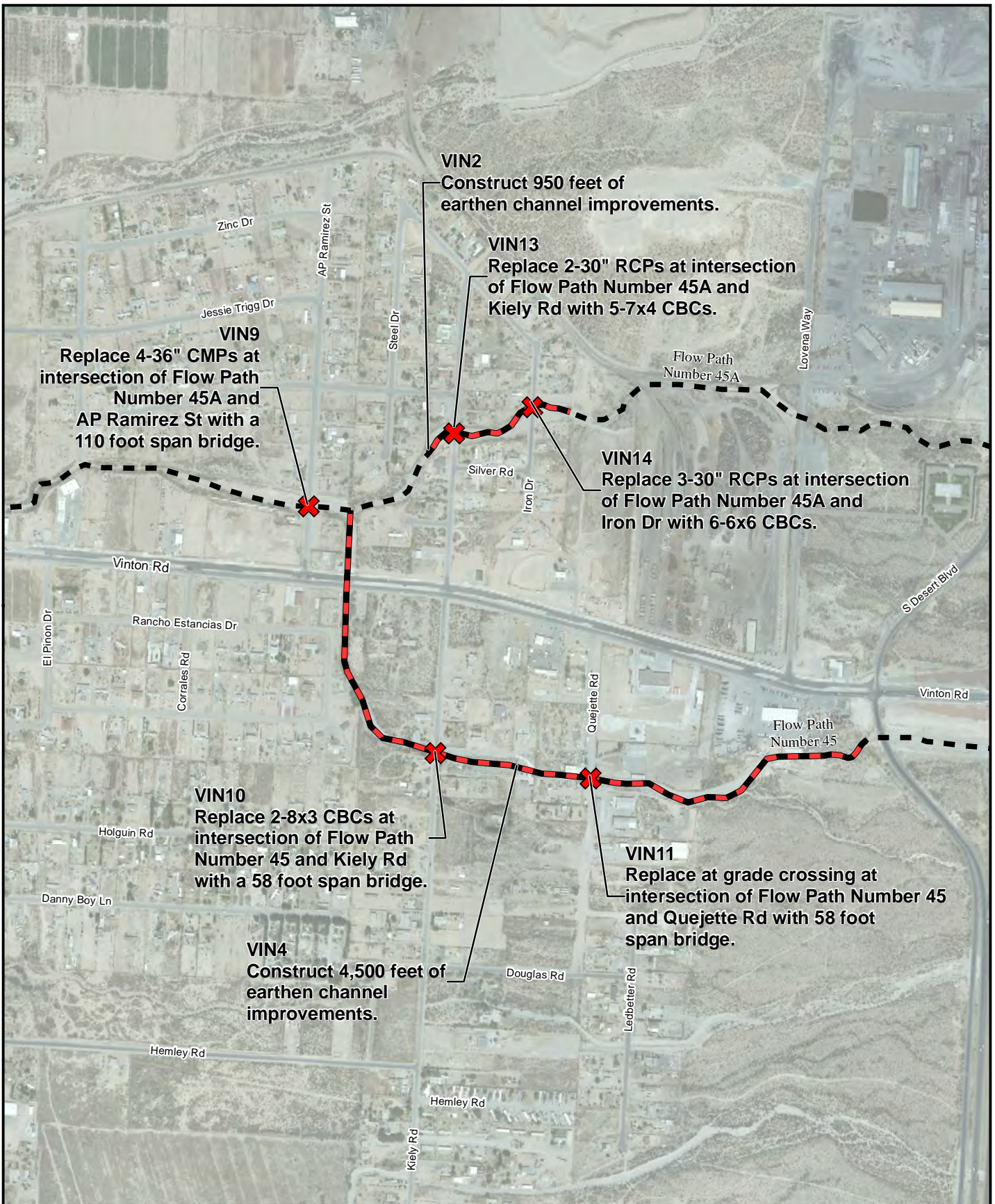

VIN2
Construct 950 feet of earthen channel improvements.

VIN13
Replace 2-30" RCPs at intersection of Flow Path Number 45A and Kiely Rd with 5-7x4 CBCs.

VIN9
Replace 4-36" CMPs at intersection of Flow Path Number 45A and AP Ramirez St with a 110 foot span bridge.

VIN14
Replace 3-30" RCPs at intersection of Flow Path Number 45A and Iron Dr with 6-6x6 CBCs.

VIN10
Replace 2-8x3 CBCs at intersection of Flow Path Number 45 and Kiely Rd with a 58 foot span bridge.

VIN11
Replace at grade crossing at intersection of Flow Path Number 45 and Quejette Rd with 58 foot span bridge.

VIN4
Construct 4,500 feet of earthen channel improvements.

File: P:\06 PROJECT DELIVERABLES\06.01 SMP\Section 6\Alternatives_VIN2.mxd

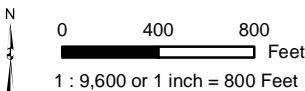

- Legend**
- Existing Channel
 - Recommended Improvements
 - Proposed Channel Solution
 - ✗ Undersized Crossing

**Vinton Study Area
VIN2, VIN4, VIN9 to
VIN11, VIN13, and VIN14**

El Paso County
Stormwater Master Plan



August 2010

Figure 6-3



VIN5
Construct 2,054 feet of earthen channel improvements.

VIN6
Replace 1-16x5 CBC at intersection of Flow Path Number 44 and Doniphan Dr with 3-9x8 CBCs.

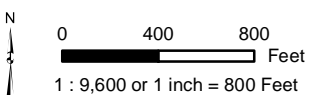

- Legend**
- Existing Channel
 - Recommended Improvements
 - Proposed Channel Solution
 - Undersized Crossing

**Vinton Study Area
VIN5 and VIN6**
El Paso County
Stormwater Master Plan

August 2010

Figure 6-4

File: P:\06 PROJECT DELIVERABLES\06.01 SMP\Section 6\Alternatives_VIN5.mxd





VIN8
 Replace 2-6x6 CBCs at
 intersection of Flow Path
 Number 45 and Doniphan Dr
 with 56 foot span bridge.

VIN7
 Replace bridge at intersection
 of Flow Path Number 45
 and railroad with 84 foot span bridge.

File: P:\06 PROJECT DELIVERABLES\06.01 SMP\Section 6\Alternatives_VIN7.mxd



0 250 500 Feet
 1 : 6,000 or 1 inch = 500 Feet

Legend

- Existing Channel
- Recommended Improvements*
- Undersized Crossing

**Vinton Study Area
 VIN7 and VIN8**

El Paso County
 Stormwater Master Plan



August 2010

Figure 6-5



File: P:\06 PROJECT DELIVERABLES\06.01 SMP\Section 6\Alternatives_CAN1.mxd



0 600 1,200 Feet
1 : 14,400 or 1 inch = 1,200 Feet

Legend

- Existing Channel
- Recommended Improvements
- Proposed Channel Solution

**Canutillo Study Area
CAN1**

El Paso County
Stormwater Master Plan



August 2010

Figure 6-6

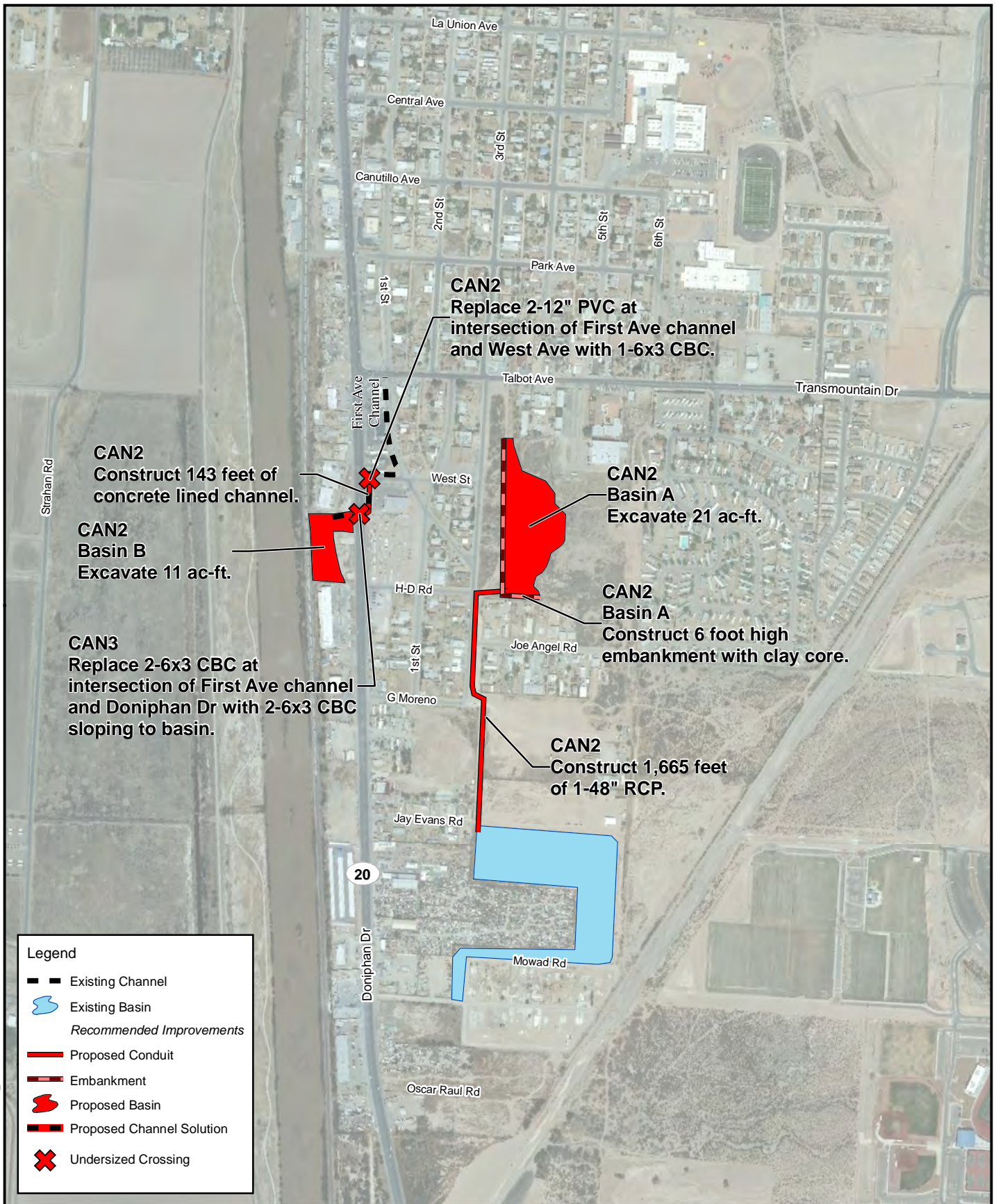

Legend

- Existing Channel
- Existing Basin
- Recommended Improvements*
- Proposed Conduit
- Embankment
- Proposed Basin
- Proposed Channel Solution
- Undersized Crossing

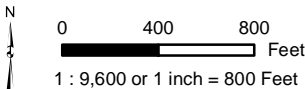

**Canutillo Study Area
CAN2 and CAN3**

El Paso County
Stormwater Master Plan

August 2010

Figure 6-7

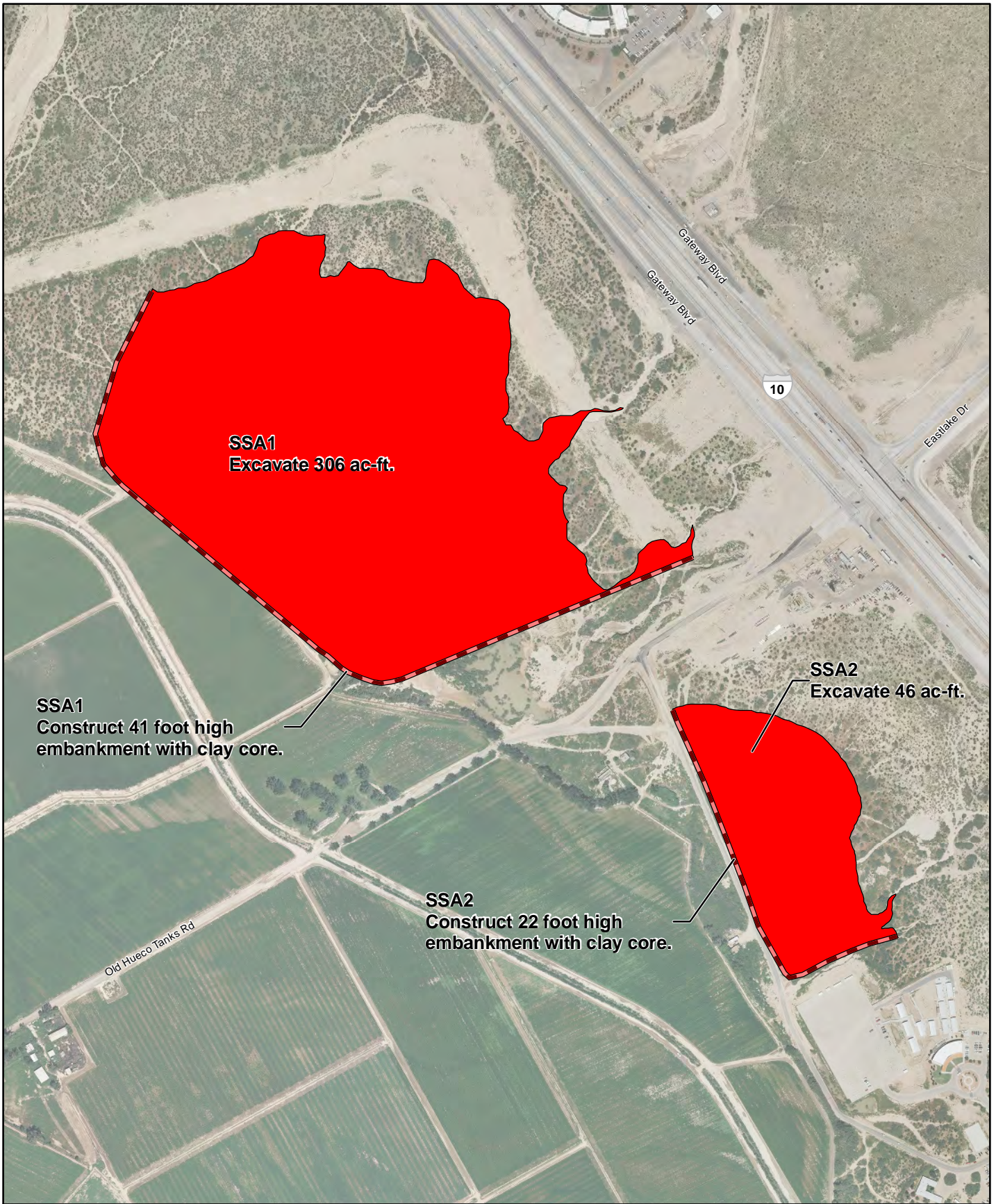

SSA1
Construct 41 foot high embankment with clay core.

SSA1
Excavate 306 ac-ft.

SSA2
Excavate 46 ac-ft.

SSA2
Construct 22 foot high embankment with clay core.



0 300 600 Feet
1 : 7,200 or 1 inch = 600 Feet

Legend

Recommended Improvements

- Proposed Basin
- Embankment

**Sparks Arroyo and Sub Basin A
Study Area
SSA1 and SSA2**

El Paso County
Stormwater Master Plan

August 2010

Figure 6-8





Construct 1,100 feet of concrete lined channel improvements.





Excavate 67 ac-ft.

Construct 36 foot high embankment with clay core.

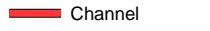

0 300 600 Feet
1 : 7,200 or 1 inch = 600 Feet

Legend

-  Existing Channel
- Recommended Improvements*
-  Proposed Basin
-  Channel
-  Embankment

Sparks Arroyo and Sub Basin A Study Area SSA3

El Paso County Stormwater Master Plan

August 2010

Figure 6-9



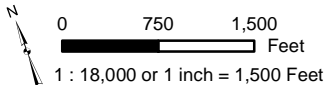
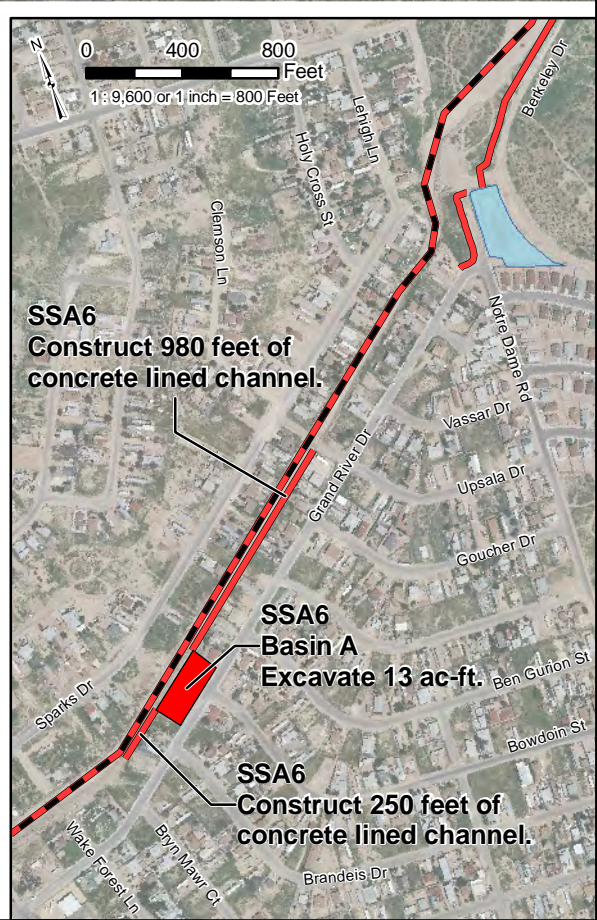
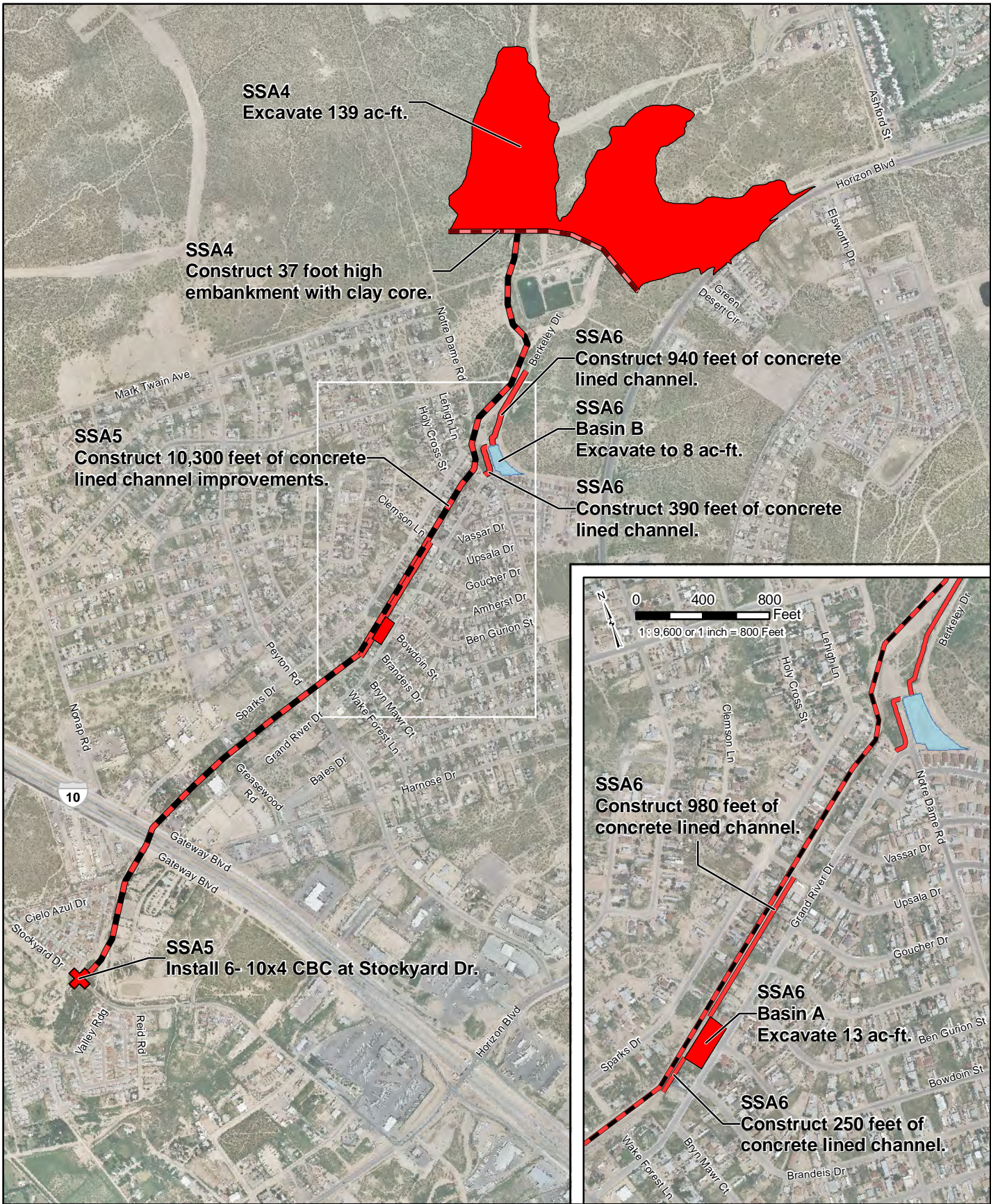

Legend

- Existing Channel
- Existing Basin
- Proposed Basin
- Channel
- Undersized Crossing
- Embankment

**Sparks Arroyo and Sub Basin A Study Area
SSA4, SSA5, and SSA6**

El Paso County
Stormwater Master Plan

August 2010

Figure 6-10





P:\GIS_Projects\EP\U\County\SM\PM\XD\Report\F6-10_AIL SOC12_SOC13_SOC14.mxd





0 300 600 Feet
1 : 7,200 or 1 inch = 600 Feet

Legend

-  Existing Channel
- Recommended Improvements**
-  Proposed Basin
-  Channel
-  Embankment

Sparks Arroyo and Sub Basin A Study Area SSA7

El Paso County Stormwater Master Plan

August 2010

Figure 6-11



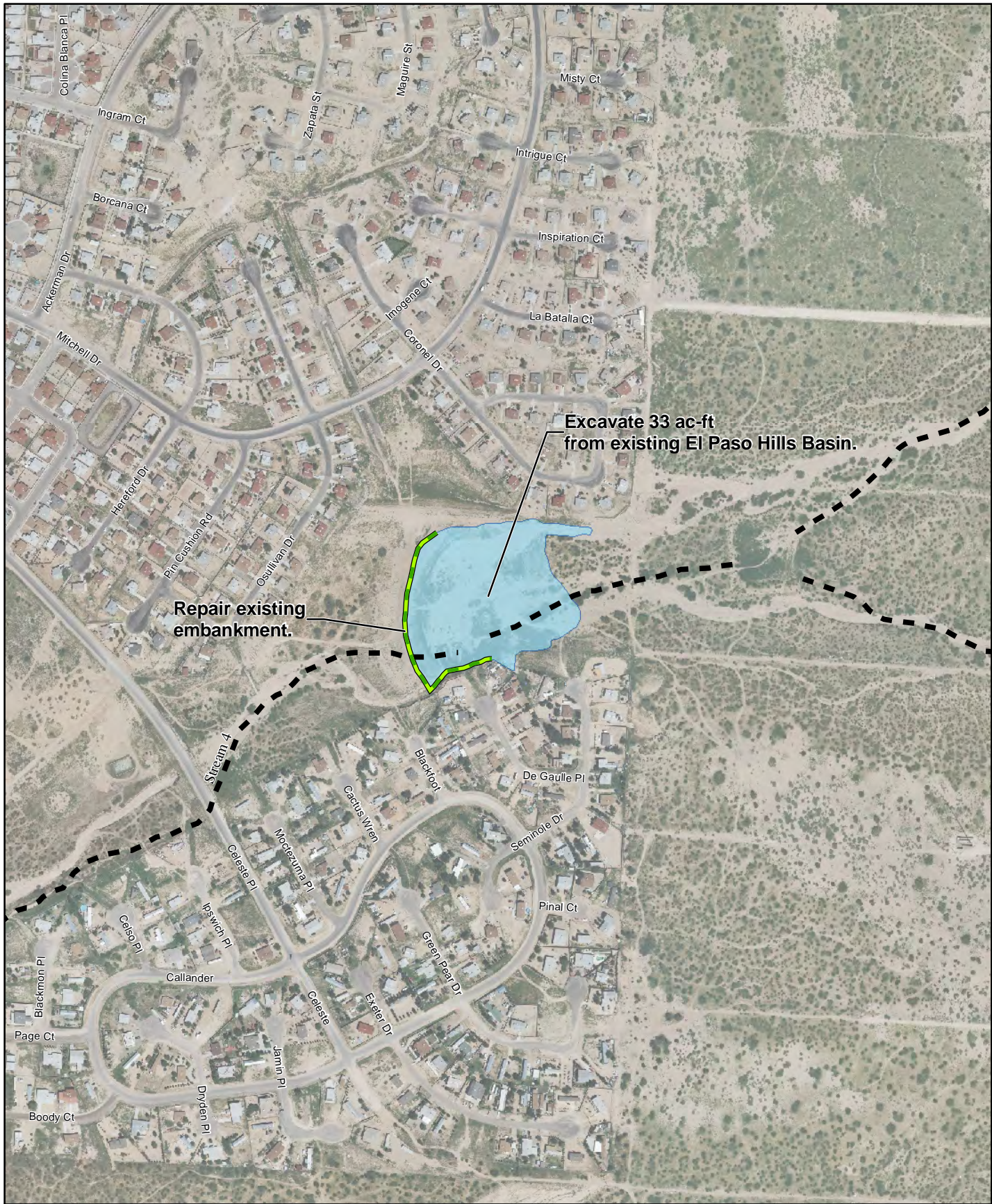



Excavate 33 ac-ft from existing El Paso Hills Basin.

Repair existing embankment.



0 250 500 Feet
1 : 6,000 or 1 inch = 500 Feet

Legend

-  Existing Embankment
-  Existing Channel
-  Existing Basin

**Socorro Study Area
SOC1**

El Paso County
Stormwater Master Plan

August 2010



Figure 6-12





0 250 500 Feet
 1 : 6,000 or 1 inch = 500 Feet

Legend

-  Existing Channel
- Recommended Improvements*
-  Embankment
-  Proposed Basin

**Socorro Study Area
 SOC2**

El Paso County
 Stormwater Master Plan

August 2010



Figure 6-13





0 250 500 Feet
 1 : 6,000 or 1 inch = 500 Feet

Legend

-  Existing Channel
- Recommended Improvements*
-  Embankment
-  Proposed Basin

**Socorro Study Area
 SOC3**

El Paso County
 Stormwater Master Plan

August 2010

Figure 6-14



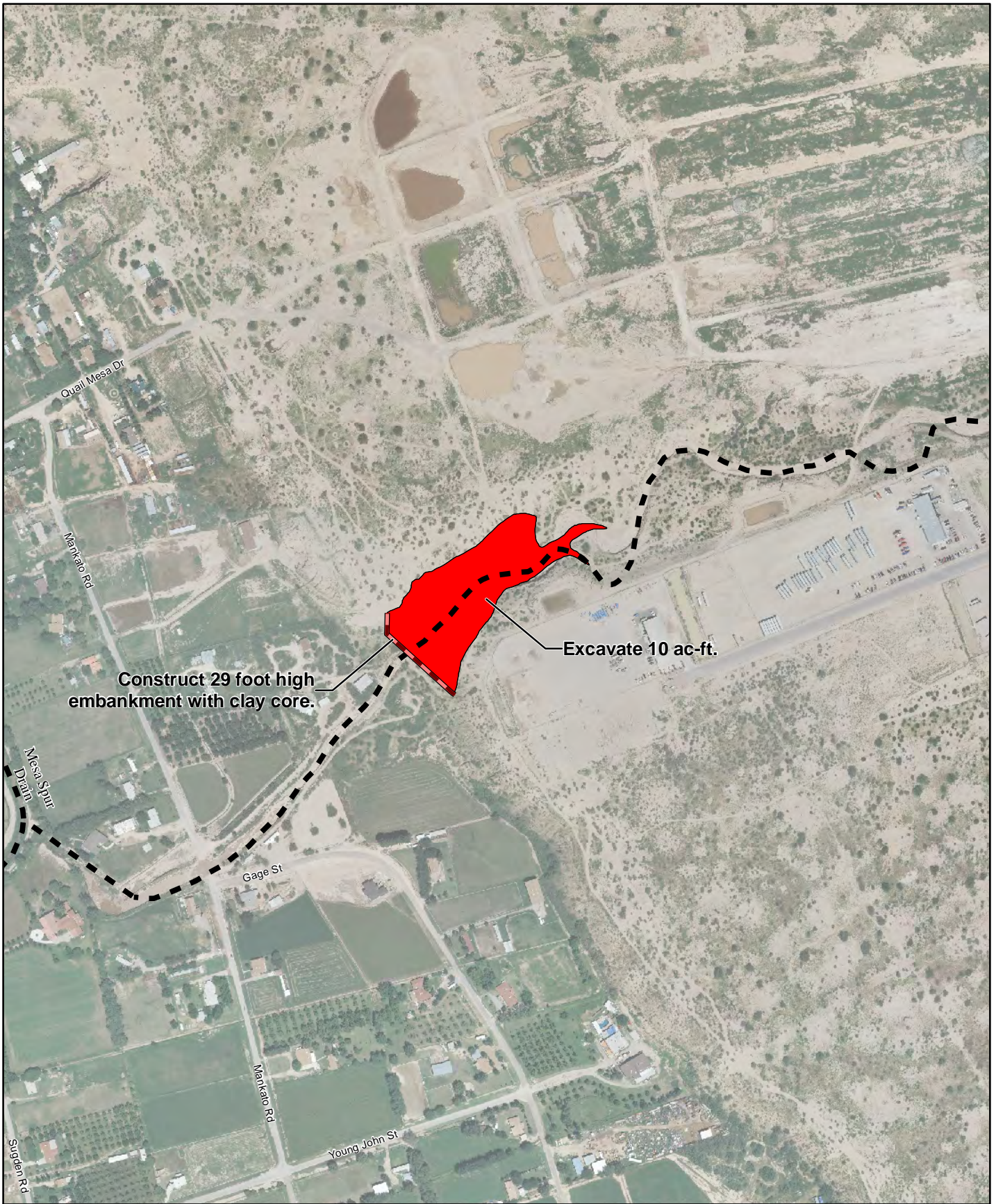

Construct 29 foot high embankment with clay core.

Excavate 10 ac-ft.



0 250 500 Feet
1 : 6,000 or 1 inch = 500 Feet

Legend

- Existing Channel
- Recommended Improvements**
- Embankment
- Proposed Basin

**Socorro Study Area
SOC4**

El Paso County
Stormwater Master Plan

August 2010

Figure 6-15



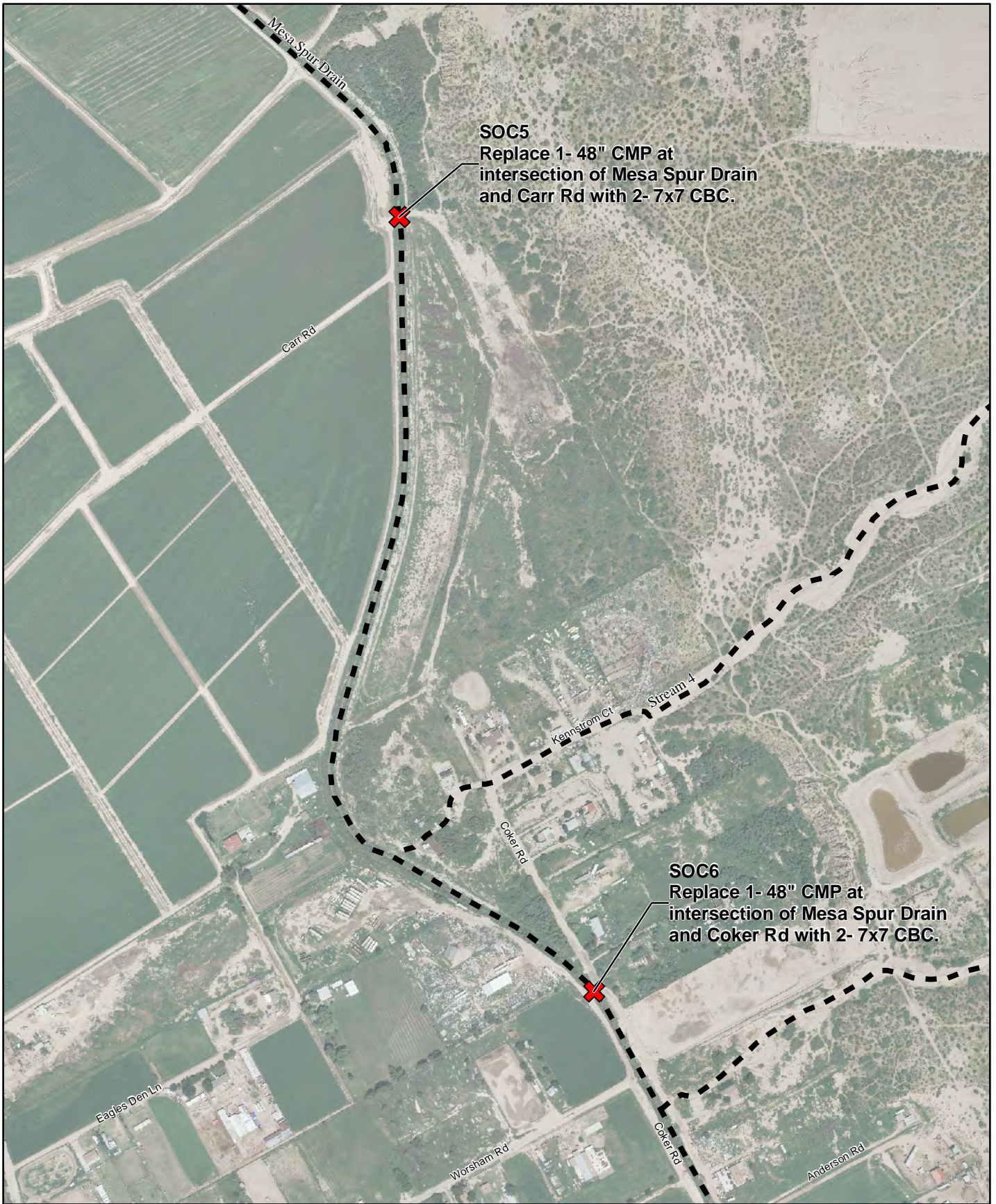

SOC5
 Replace 1- 48" CMP at
 intersection of Mesa Spur Drain
 and Carr Rd with 2- 7x7 CBC.

SOC6
 Replace 1- 48" CMP at
 intersection of Mesa Spur Drain
 and Coker Rd with 2- 7x7 CBC.

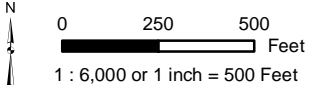

- Legend**
- Existing Channel
 - X** Recommended Improvements
 - X** Undersized Crossing

**Socorro Study Area
 SOC5 and SOC6**

El Paso County
 Stormwater Master Plan

August 2010

Figure 6-16

P:\GIS_Projects\EP\U\County\MP\MXD\Report\F6-16_AIL_SOC5_SOC6.mxd







SOC7
 Replace 1- 48" CMP at
 intersection of Mesa Spur Drain
 and Anderson Rd with 2- 7x7 CBC.

SOC8
 Replace 1- 60" CMP at
 intersection of Mesa Spur Drain
 and Mesa Drain with 2- 7x7 CBC.



0 250 500
 Feet
 1 : 6,000 or 1 inch = 500 Feet

Legend

-  Existing Channel
- X** Recommended Improvements
-  Undersized Crossing

**Socorro Study Area
 SOC7 and SOC8**

El Paso County
 Stormwater Master Plan

August 2010

Figure 6-17



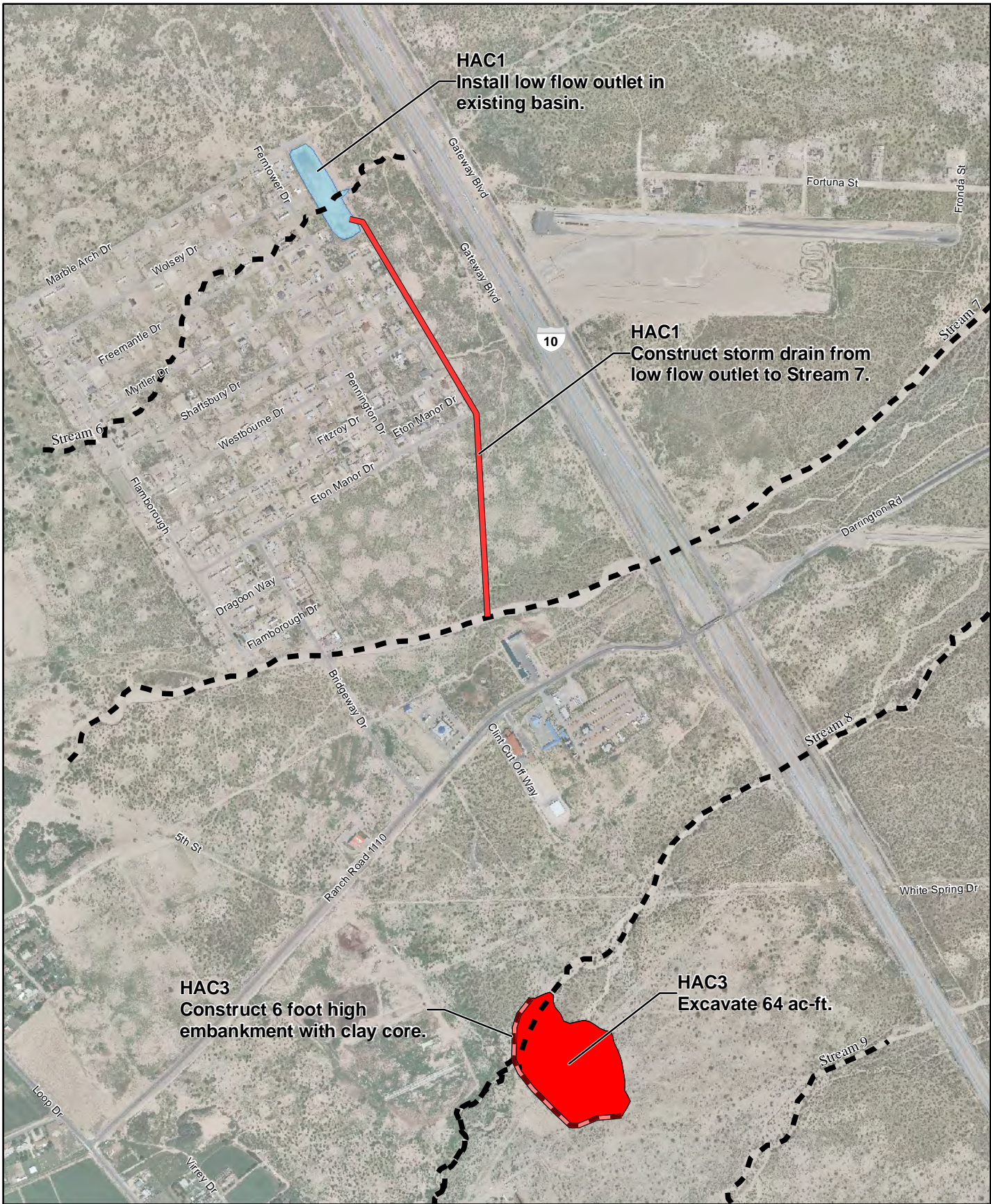

HAC1
Install low flow outlet in existing basin.

HAC1
Construct storm drain from low flow outlet to Stream 7.

HAC3
Construct 6 foot high embankment with clay core.

HAC3
Excavate 64 ac-ft.

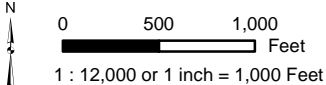

- Legend**
- Existing Channel
 - Existing Basin
 - Conduit
 - Embankment
 - Proposed Basin

**Hacienda Real Study Area
HAC1 and HAC3**

El Paso County
Stormwater Master Plan

August 2010

Figure 6-18

P:\GIS_Projects\EP\U\County\SM\PM\XD\Report\F6-18_AIL_HAC1_HAC3.mxd



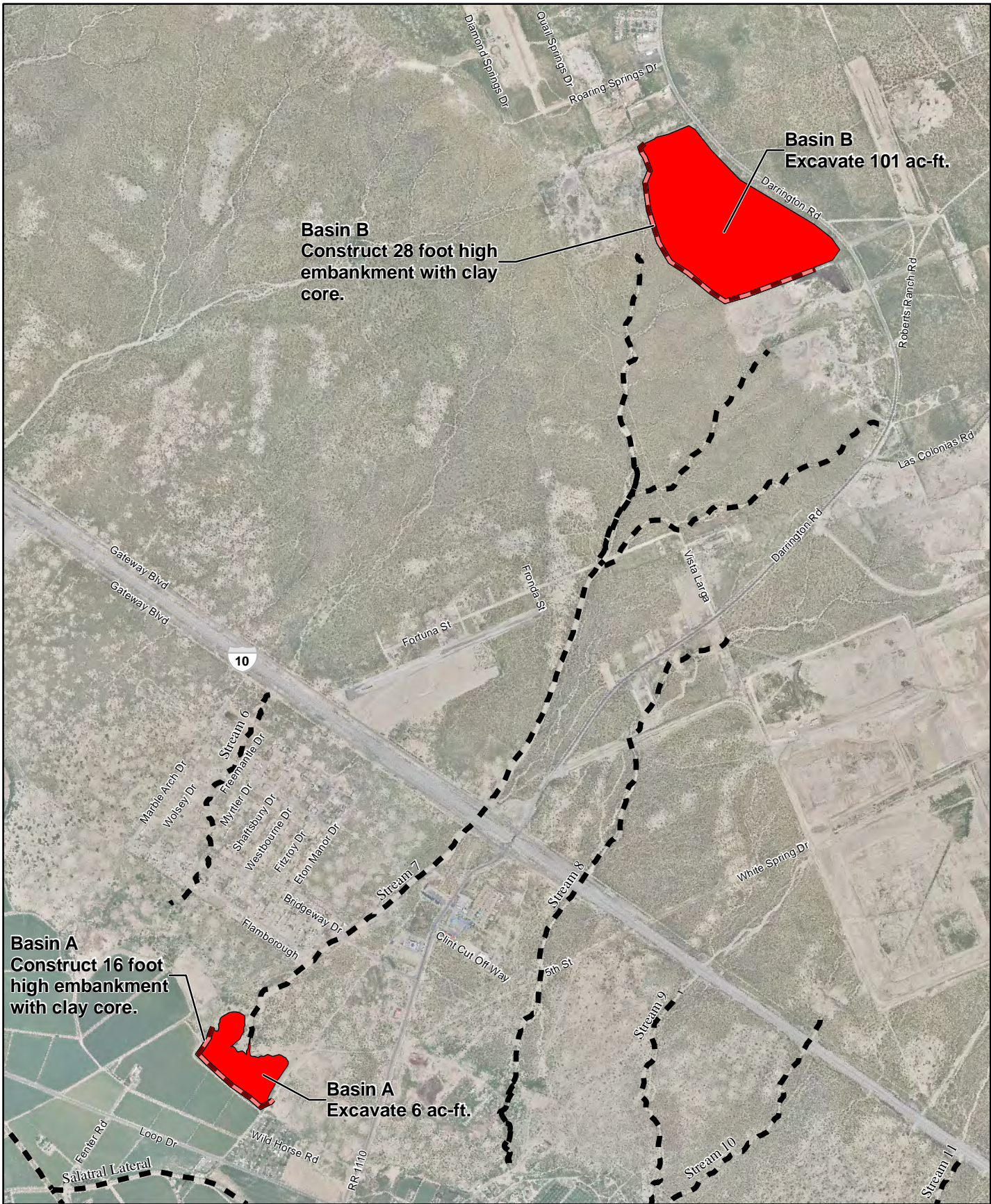

Basin B
Construct 28 foot high embankment with clay core.

Basin B
Excavate 101 ac-ft.

Basin A
Construct 16 foot high embankment with clay core.

Basin A
Excavate 6 ac-ft.

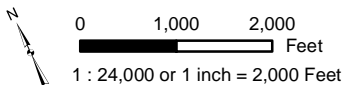

- Legend**
- Existing Channel
 - Recommended Improvements*
 - Embankment
 - Red shape Proposed Basin

**Hacienda Real Study Area
HAC2**

El Paso County
Stormwater Master Plan

August 2010

Figure 6-19

P:\GIS_Projects\EP\U\County\SM\PM\XD\Report\F6-19_AIL_HAC2.mxd



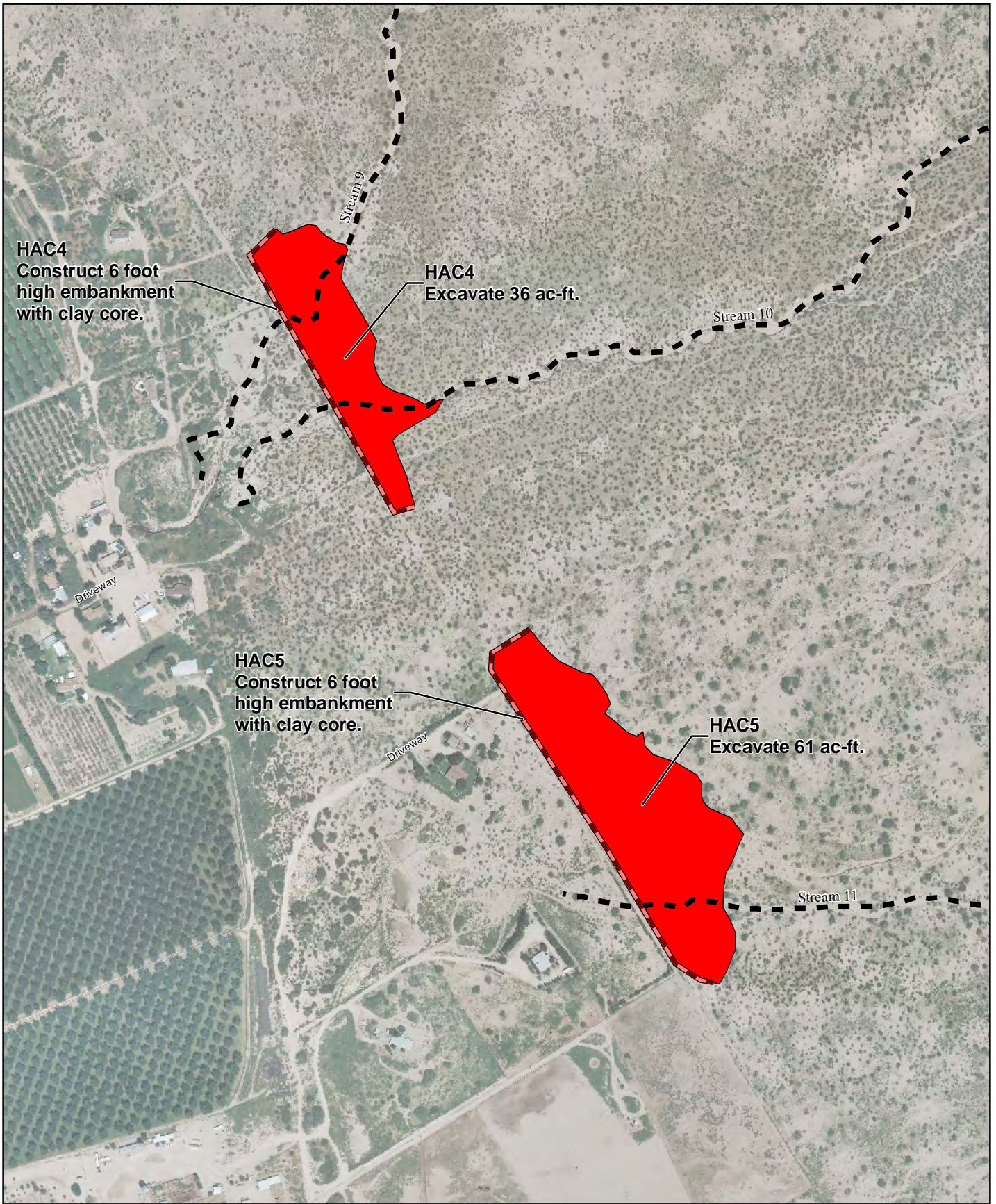

HAC4
Construct 6 foot
high embankment
with clay core.

HAC4
Excavate 36 ac-ft.

HAC5
Construct 6 foot
high embankment
with clay core.

HAC5
Excavate 61 ac-ft.



0 250 500
Feet
1 : 6,000 or 1 inch = 500 Feet

Legend

- Existing Channel
- Recommended Improvements*
- Conduit
- Embankment
- Proposed Basin



**Hacienda Real Study Area
HAC4 and HAC5**

El Paso County
Stormwater Master Plan

August 2010

Figure 6-20

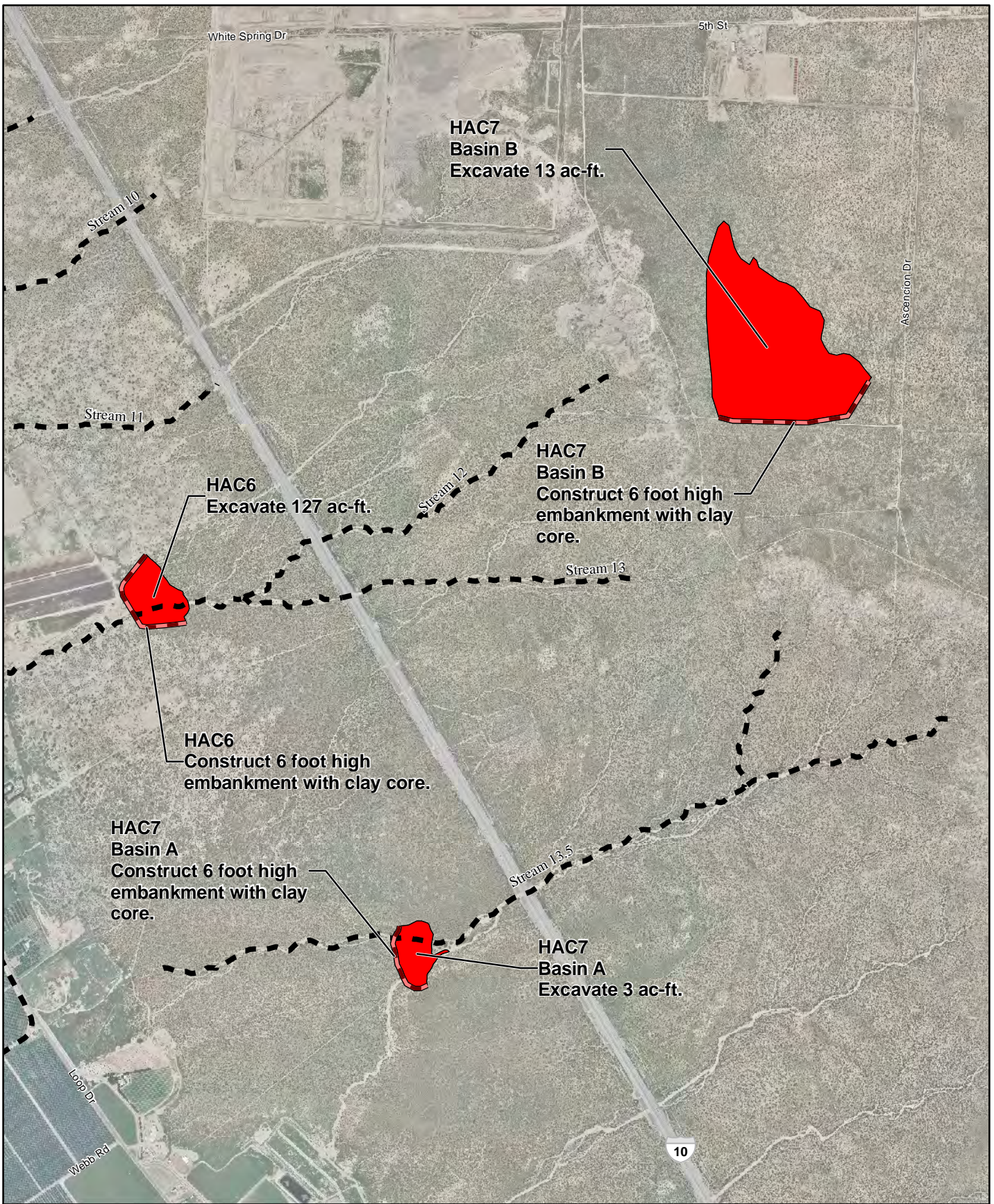

P:\GIS_Projects\EP\U\County\SM\PM\XD\Report\F6-21_AIL_HAC6_HAC7.mxd



0 1,000 2,000
Feet
1 : 24,000 or 1 inch = 2,000 Feet

Legend

- Existing Channel
- Recommended Improvements**
- Conduit
- Embankment
- Proposed Basin

**Hacienda Real Study Area
HAC6 and HAC7**

El Paso County
Stormwater Master Plan

August 2010

Figure 6-21



URS



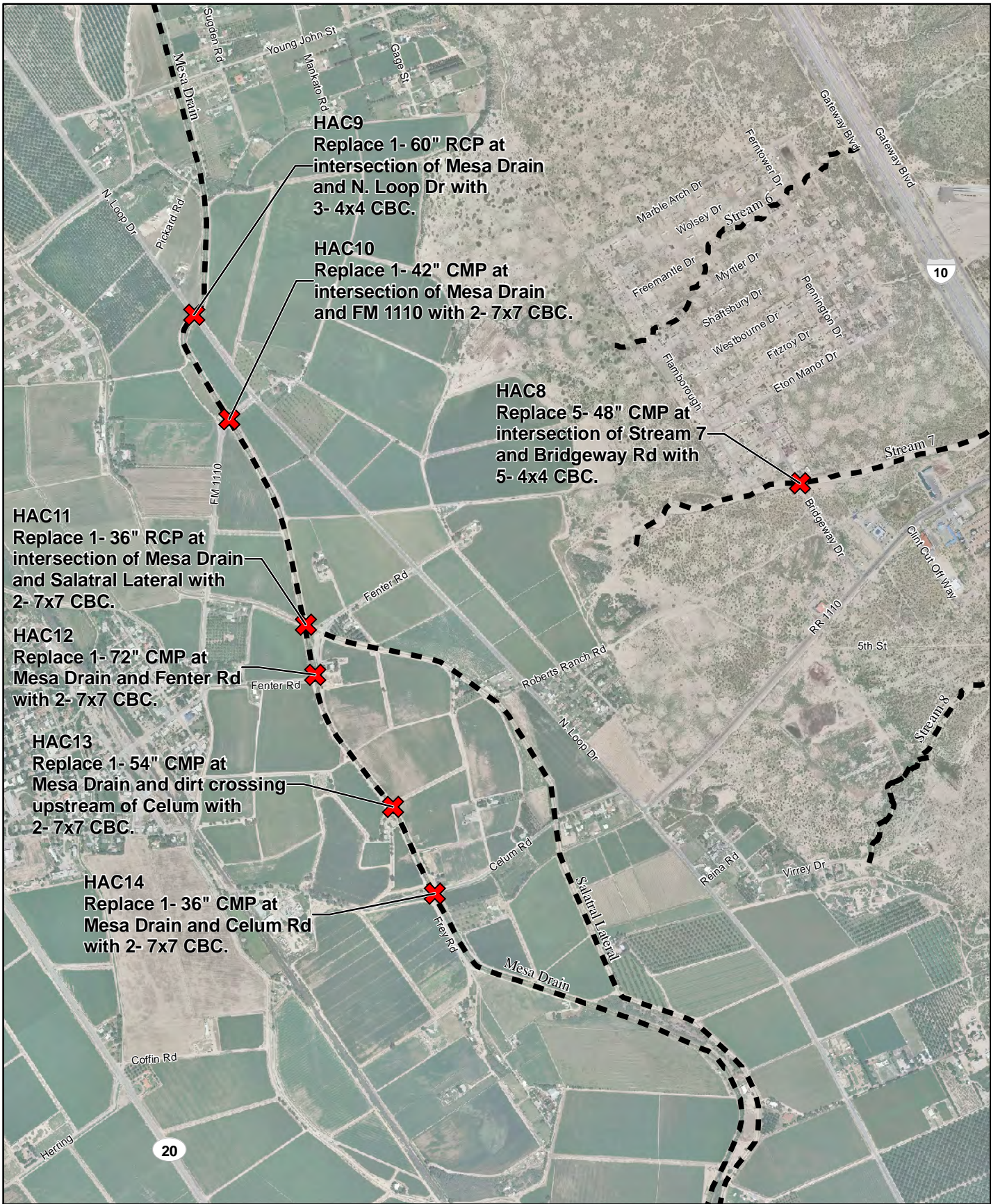

P:\GIS_Projects\EP\U\County\SM\PM\XD\Report\F6-22_AIL_HAC8_HAC14.mxd



0 750 1,500
Feet
1 : 18,000 or 1 inch = 1,500 Feet

Legend

- Existing Channel
- Recommended Improvements
- ✘ Undersized Crossing



**Hacienda Real Study Area
HAC8, HAC9, HAC10, HAC11
HAC12, HAC13, and HAC14**

El Paso County
Stormwater Master Plan

August 2010

Figure 6-22

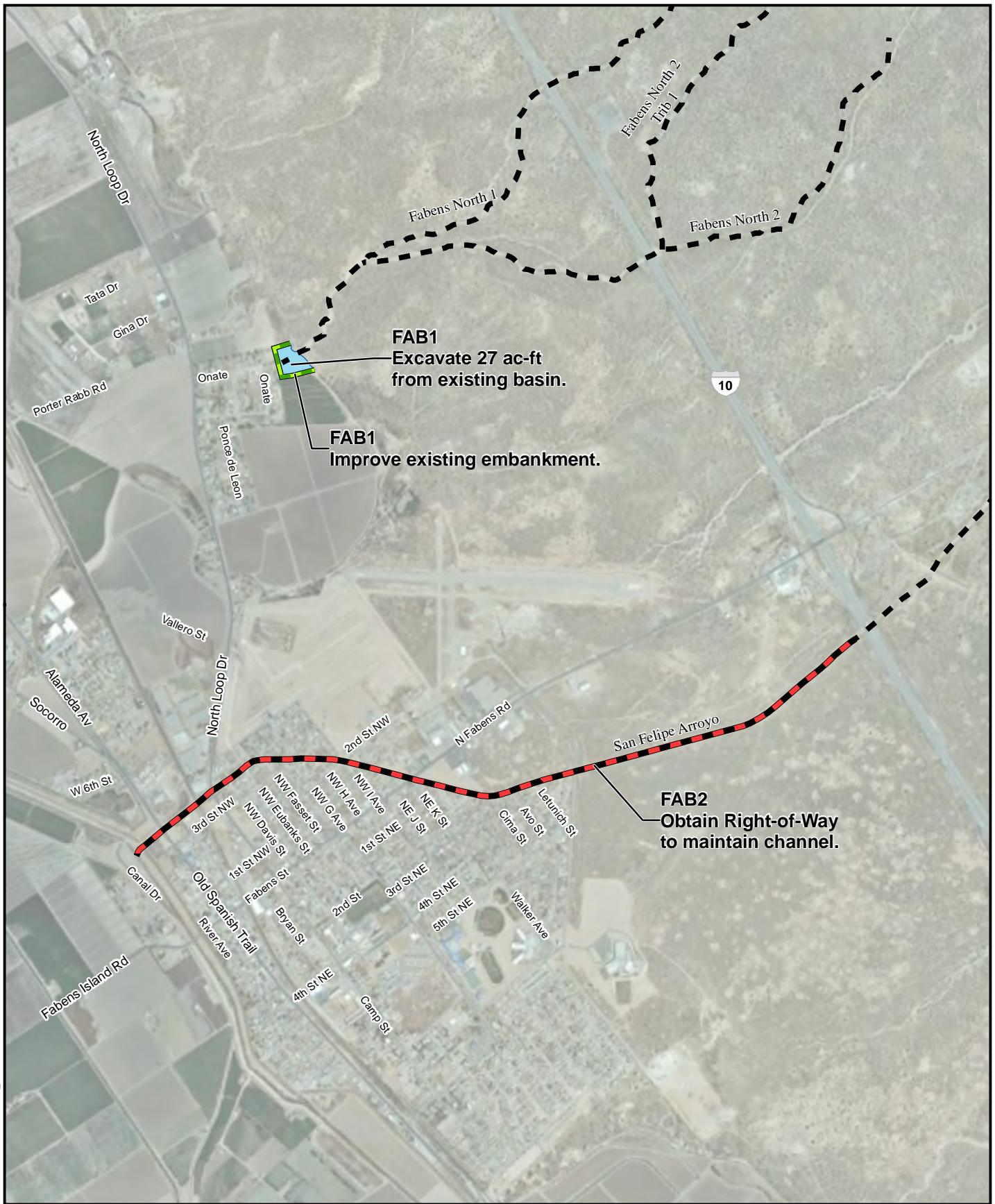

File: P:\06 PROJECT DELIVERABLES\06.01 SMP\Section 6\Alternatives_FAB1.mxd



0 1,000 2,000 Feet
1 : 24,000 or 1 inch = 2,000 Feet

Legend

- Existing Embankment
- Existing Channel
- Existing Basin
- Recommended Improvements*
- Proposed Channel Solution

**Fabens Study Area
FAB1 and FAB2**

El Paso County
Stormwater Master Plan



August 2010

Figure 6-23

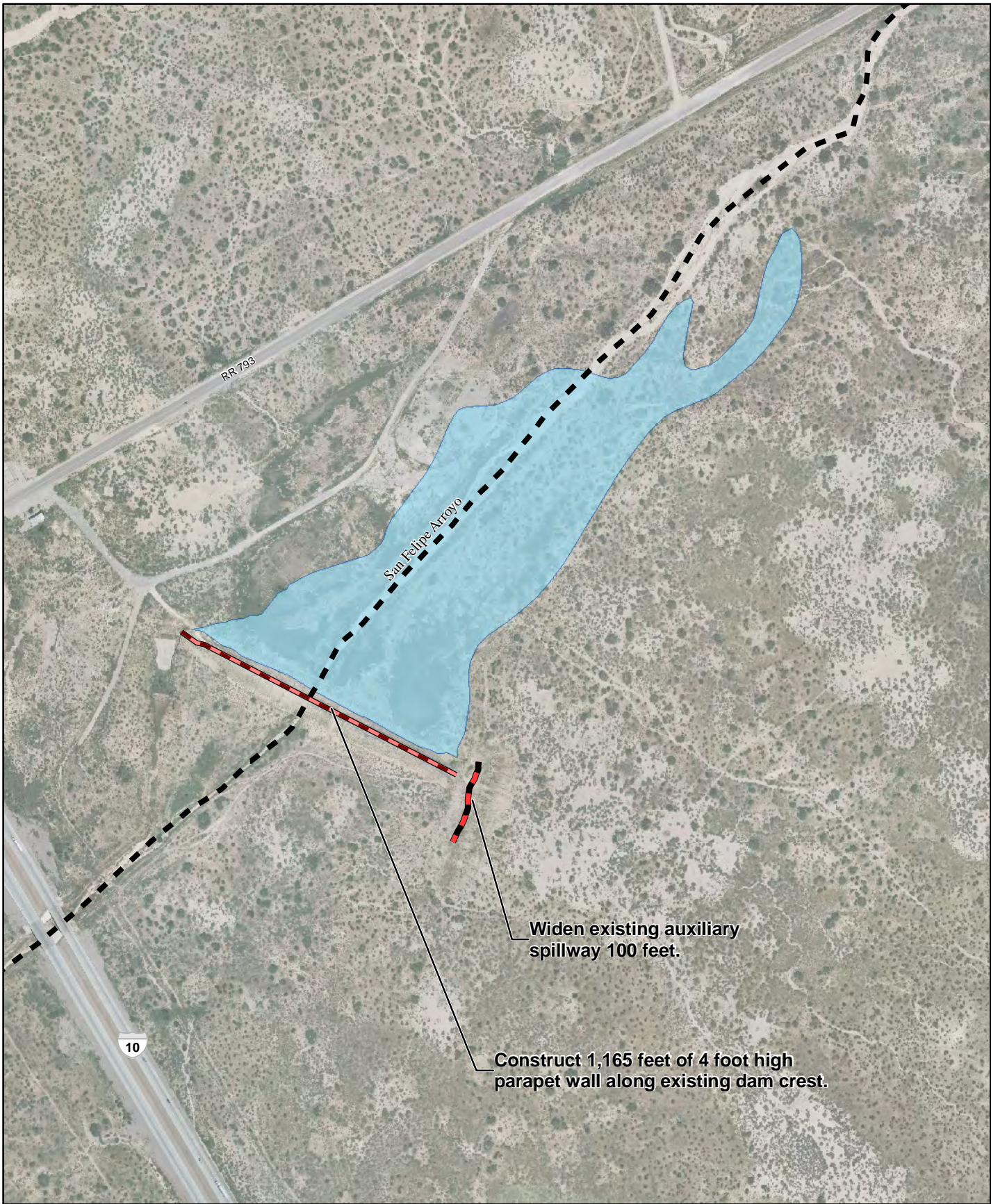

0 250 500 Feet
 1 : 6,000 or 1 inch = 500 Feet

Legend

-  Existing Channel
- Recommended Improvements*
-  Embankment
-  Channel
-  Existing Basin

**Fabens Study Area
 FAB3**

El Paso County
 Stormwater Master Plan

August 2010

Figure 6-24



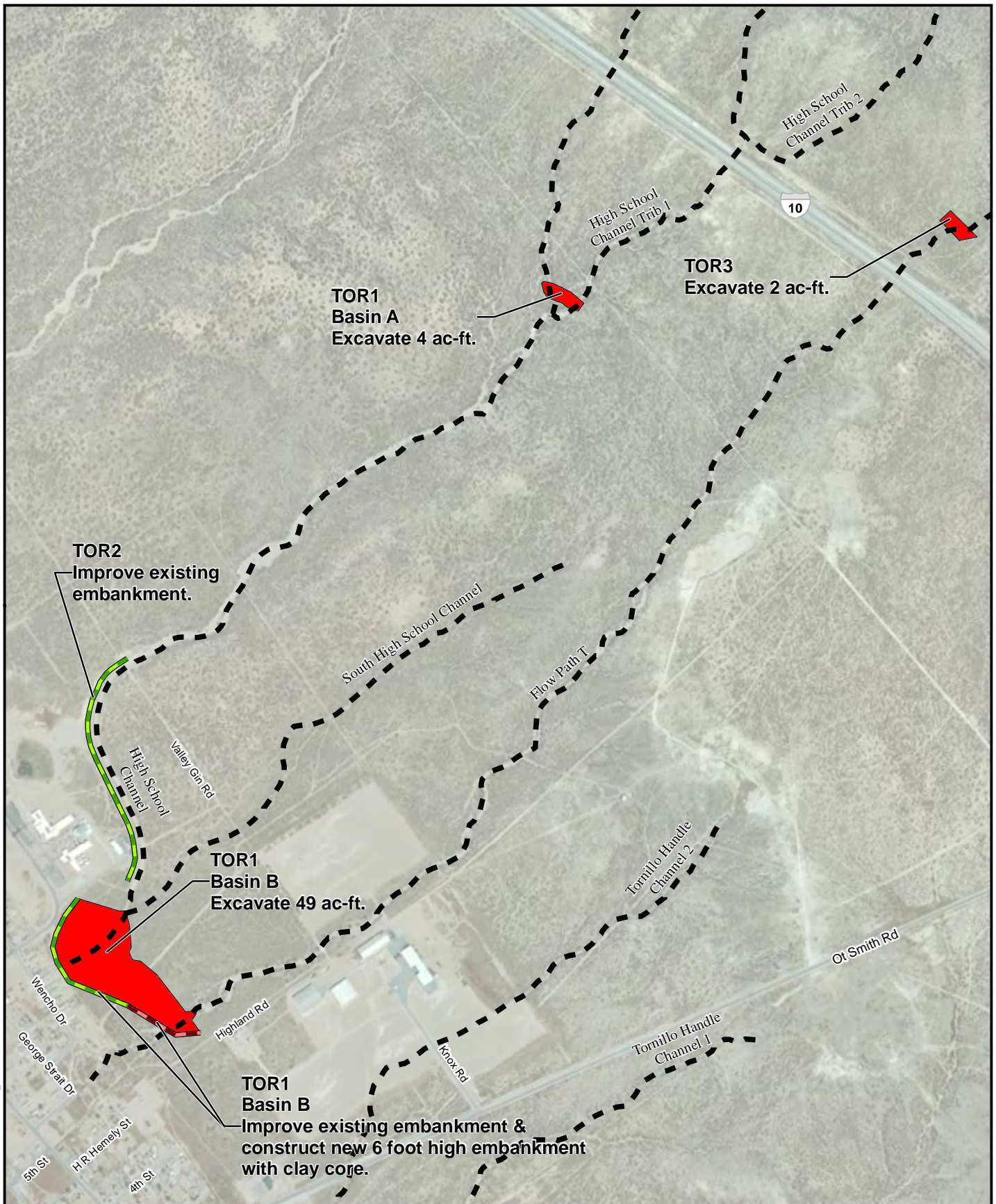

File: P:\06 PROJECT DELIVERABLES\06.01 SMP\Section 6\Alternatives_TOR1.mxd



0 600 1,200
Feet
1 : 14,400 or 1 inch = 1,200 Feet

Legend

- Existing Embankment
- Existing Channel
- Recommended Improvements*
- Embankment
- Proposed Basin

**Tornillo Study Area
TOR1 to TOR3**

El Paso County
Stormwater Master Plan



August 2010

Figure 6-25

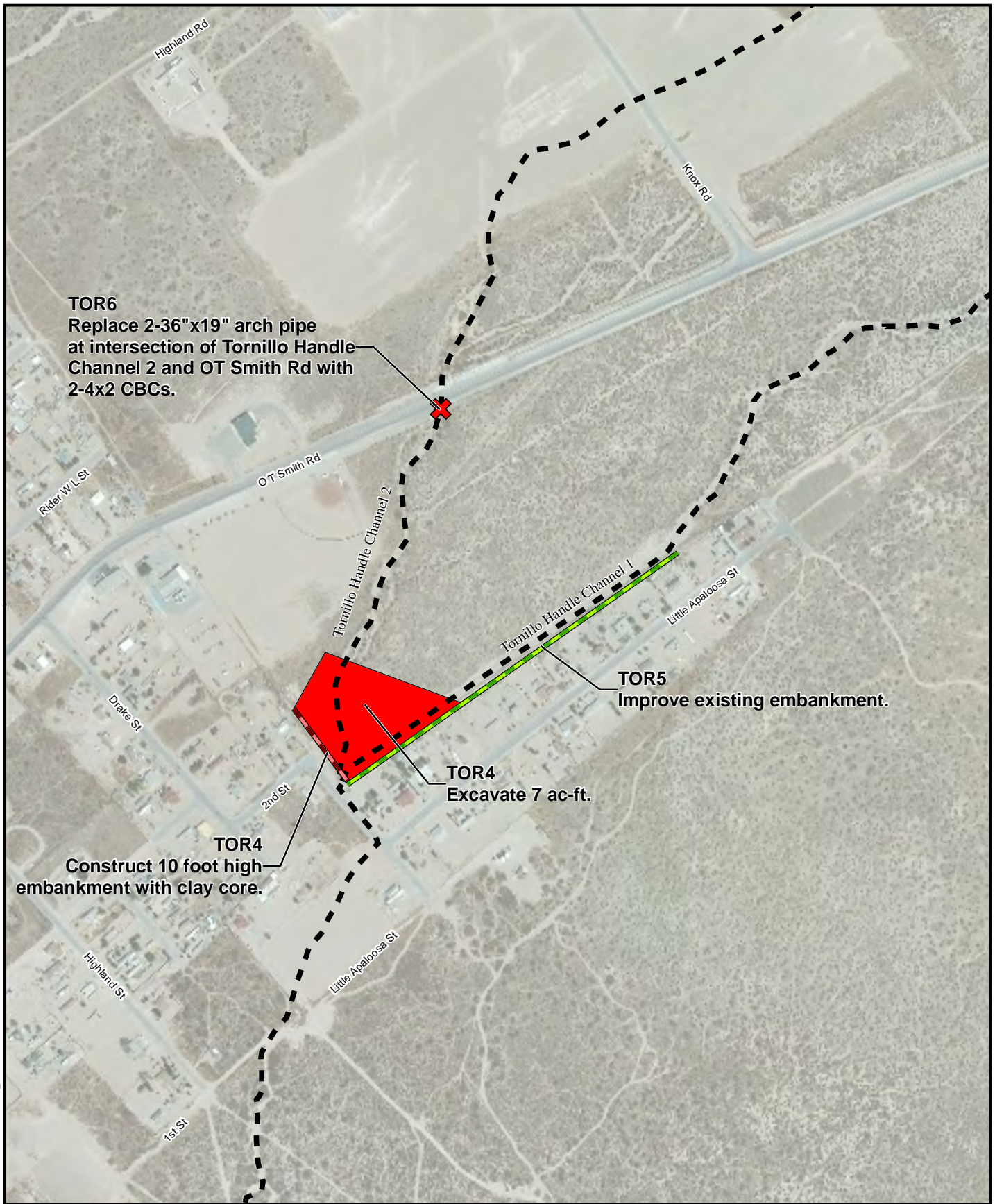

TOR6
 Replace 2-36"x19" arch pipe
 at intersection of Tornillo Handle
 Channel 2 and OT Smith Rd with
 2-4x2 CBCs.

TOR5
 Improve existing embankment.

TOR4
 Excavate 7 ac-ft.

TOR4
 Construct 10 foot high
 embankment with clay core.



0 250 500 Feet
 1 : 6000 or 1 inch = 500 Feet

Legend

- Existing Embankment
- Existing Channel
- Recommended Improvements*
- Embankment
- Proposed Basin
- Undersized Crossing

**Tornillo Study Area
 TOR4 to TOR6**

El Paso County
 Stormwater Master Plan

August 2010

Figure 6-26



7.0 PRIORITIZATION OF SELECTED PROJECTS

All of the projects discussed in this SMP provide protection from flooding for some group of affected individuals and property. The natural tendency is for everyone to think that their project is the most important and should be constructed first. The reality is that there are limited funds available and that not all the projects can be funded initially. Therefore, an effort was made to rank the projects to provide the County and affected communities a rationale for deciding the relative priority for funding the individual projects.

The first task of the prioritization process was to identify the major concerns associated with stormwater management. The major concerns identified to be addressed by the proposed stormwater improvements were:

- Reduce flooding of real property (residences, commercial/industrial and agricultural land);
- Reduce uncontrolled sediment deposition;
- Reduce flooding of critical transportation arteries (e.g. IH-10, Doniphan Road, etc.); and
- Reduce maintenance.

The second task was to develop relative risk index values for each of the above issues for each project. The third task was to use these relative risk index values to assign a priority category (I, II, and III) to each project. The final task was to rank those projects in Category I into three subcategories (high, medium, and low priority).

Representatives from the major stakeholders participated in the prioritization process during Working Meetings 3 and 4 in late April 2010. These meetings included representatives from:

- El Paso County;
- EPWU;
- City of Socorro;
- Village of Vinton; and
- TWDB.

The results of the prioritization are presented in Table 7-1. In addition to the total estimated project cost, an estimated cost for the 25-Year Return Interval Basin Design is shown in this table for Category I projects including basins. The 25-year return interval cost is provided to give an idea of the potential cost savings that could be realized by providing protection for the 25-year flood vs. the 100-year flood. Detailed information regarding the estimated project costs and the prioritization process can be found in Appendix C.

The projects listed in Table 7-1 are grouped as follows:

Category	Priority	Number of Projects	Total Cost	Cost for 25-Year Return Interval Basin Design
I	High	13	\$54,500,000	37,420,000
I	Medium	3	\$12,440,000	\$7,220,000
I	Low	5	\$46,710,000	\$31,770,000
II		25	\$26,430,000	NA
III		8	\$13,380,000	NA
Total		54	\$153,460,000	

The projects are listed in Table 7-1 within each of the Category and Priority groups in order of cost, from low to high. There was no attempt to provide an absolute ranking of projects. The prioritization given in Table 7-1 is based on the information and assumptions provided in Appendix C. This prioritization process was a subjective, qualitative ranking of the projects and not intended to define the specific order in which projects are funded, but rather to be a tool that can be used to help prioritize projects. Actual prioritization and funding of projects will be determined by the County and affected communities.

Table 7-1. Prioritization Summary

Project No.	Description	Estimated Total Cost (Rounded to \$10,000)	Estimated Cost for 25-Year Return Interval Basin Design (Rounded to \$10,000)	Type of Improvement			Prioritization	
				Basin	Crossing	Channel	Category	Priority within Category I
VIN3*	1,600' of Channel Improvements	\$120,000	N/A			X	I	high
VIN13*	5 - 7' x 4' CBC	\$260,000	N/A		X		I	high
VIN14*	6 - 6' x 6' CBC	\$310,000	N/A		X		I	high
VIN11*	58' span bridge	\$700,000	N/A		X		I	high
VIN10*	58' span bridge	\$730,000	N/A		X		I	high
VIN5	2,054' of Channel Improvements	\$860,000	N/A			X	I	high
VIN4*	4,500' of Channel Improvements - property acquisition not included	\$860,000	N/A			X	I	high
FAB3	Upgrade Fabens Dam	\$1,340,000	N/A	X			I	high
VIN9*	110' span bridge	\$1,410,000	N/A		X		I	high
CAN1	Reconstruction of the channel with concrete lining	\$1,440,000	N/A			X	I	high
CAN2	Retention Basin (CAN2B); 1 - 6' x 3' CBC; 143' Channel Improvements; Retention Basin (CAN2A) - 6-foot embankment; 1,665' principal spillway from CAN2A to existing basin	\$4,360,000	\$3,560,000	X			I	high
SSA7	Retention Basin SSA7; Concrete Lined Channel; 6 - 5' x 4' CBC; 6 - 5' x 4' CBC; 6 - 5' x 4' CBC; 6 - 5' x 4' CBC	\$20,300,000	\$12,950,000	X			I	high
VIN1*	Sediment/Detention Basin (VIN1A) - property acquisition not included; Sediment/Detention Basin (VIN1B) - property acquisition not included; 2,240' of Channel Improvements	\$21,810,000	\$12,080,000	X			I	high
VIN2*	950' of Channel Improvements	\$240,000	N/A			X	I	medium
VIN6	3 - 9' x 8' CBC	\$600,000	N/A		X		I	medium
SSA4	Detention Basin SSA4	\$11,600,000	\$6,380,000	X			I	medium
HAC8	5 - 4' x 4' CBC (In conjunction with HAC2 Basin B)	\$460,000	N/A		X		I	low
SSA2	Detention Basin SSA2	\$4,360,000	N/A	X			I	low
SSA5	Sparks Channel; 6 - 10' x 4' CBC	\$8,690,000	N/A			X	I	low
HAC2	Sediment/Retention Basin at Location A; Sediment/Retention Basin at Location B	\$10,570,000	\$5,810,000	X			I	low
SSA1	Detention Basin SSA1	\$22,630,000	\$12,450,000	X			I	low
TOR6	2 - 4' x 2' CBC	\$50,000	N/A		X		II	
HAC9	3 - 4' x 4' CBC	\$130,000	N/A		X		II	
CAN3	2 - 6' x 3' CBC	\$140,000	N/A		X		II	
SOC6	2 - 7' x 7' CBC	\$140,000	N/A		X		II	
SOC7	2 - 7' x 7' CBC	\$160,000	N/A		X		II	
SOC5	3 - 4' x 4' CBC	\$170,000	N/A		X		II	
VIN12*	3 - 9' x 5' CBC	\$200,000	N/A		X		II	
TOR5	165' of Channel Bank Improvements	\$210,000	N/A			X	II	
SOC8	2 - 7' x 7' CBC	\$220,000	N/A		X		II	

Table 7-1. Prioritization Summary (Continued)

Project No.	Description	Estimated Total Cost (Rounded to \$10,000)	Estimated Cost for 25-Year Return Interval Basin Design (Rounded to \$10,000)	Type of Improvement			Prioritization	
				Basin	Crossing	Channel	Category	Priority within Category I
HAC13	2 - 7' x 7' CBC	\$230,000	N/A		X		II	
HAC14	2 - 7' x 7' CBC	\$250,000	N/A		X		II	
HAC11	2 - 7' x 7' CBC	\$500,000	N/A		X		II	
FAB2	Property	\$500,000	N/A			X	II	
HAC12	2 - 7' x 7' CBC	\$550,000	N/A		X		II	
VIN7*	84' span bridge	\$620,000	N/A		X		II	
HAC1	Low-level/Principal Spillway Outlet	\$750,000	N/A	X			II	
TOR2	2,030' of Channel Bank Improvements	\$810,000	N/A			X	II	
SOC3	Sediment/Detention Basin	\$870,000	N/A	X			II	
SOC4	Sediment/Detention Basin	\$1,180,000	N/A	X			II	
VIN8*	56' span bridge	\$1,260,000	N/A		X		II	
FAB1	Sediment/Retention Basin	\$2,540,000	N/A	X			II	
HAC7	Sediment/Detention Basin at Location A; Sediment/Detention Basin at Location B	\$2,710,000	N/A	X			II	
TOR1	Sediment/Retention Basin (TOR 1 & TOR3) - 6-foot embankment; Sediment Basin (TOR1A)	\$2,430,000	N/A	X			II	
SOC1 and SOC 2	Sediment/Detention Basin - SOC1; Sediment/Detention Basin - SOC2	\$3,640,000	N/A	X			II	
SSA3	Detention Basin SSA3; Concrete Lined Channel	\$6,170,000	N/A	X			II	
TOR3	Sediment Basin (TOR3A)	\$50,000	N/A	X			III	
HAC10	2 - 7' x 7' CBC	\$520,000	N/A		X		III	
TOR4	Sediment/Retention Basin	\$1,340,000	N/A	X			III	
HAC4	Sediment/Retention Basin	\$1,510,000	N/A	X			III	
SSA6	Sediment Basin SSA6_A; North Channel for Basin at Location A; South Channel for Basin at Location A; Sediment Basin SSA6_B; North Channel for Basin at Location B; South Channel for Basin at Location B	\$1,910,000	N/A	X			III	
HAC3	Sediment/Retention Basin	\$2,160,000	N/A	X			III	
HAC5	Sediment/Retention Basin	\$2,340,000	N/A	X			III	
HAC6	Sediment/Retention Basin	\$3,550,000	N/A	X			III	

*Issues, alternatives and cost identified in the City of El Paso Stormwater Master Plan (SMP).

8.0 COUNTYWIDE STORMWATER POLICY RECOMMENDATIONS

As the El Paso County SMP was being prepared, it became apparent that a number of issues contribute to drainage problems across the County. The primary issues involve construction in arroyos or drainage flow paths. This construction varies from an individual filling in private property that is in a drainage flow path to construction of subdivisions in drainage flow paths. The impacts of all this construction are additional flooding, property damage, and potential safety concerns. These problems have been observed in both incorporated and unincorporated areas of the County.

A number of factors contribute to construction within a flow path:

- Many individuals grade and build on their property without submitting drainage and grading plans to the County for review and without understanding the impacts that they are having on drainage.
- In some areas of the County, there are no clearly defined drainage channels. As a result of these ill-defined drainage flow paths, individuals may construct in the drainage flow paths without realizing that they are creating a problem. This construction can reduce the capacity of the drainage flow path and/or change the direction of flood flows.

Another overriding issue is that drainage problems often cross jurisdictional boundaries. It is not uncommon for a drainage flow path to begin in an unincorporated part of the County, and pass from one city or village into another. Therefore, two to four different entities ultimately may be affected by a single drainage flow path. Each of these entities may have its own drainage criteria, development criteria, construction permit requirements, and enforcement standards. In such a case, when one entity does not enforce drainage standards it can cause drainage problems in other entities. With multiple entities, it is also difficult to coordinate solutions and different jurisdictions may have different approaches or timelines to implement their solutions.

There appear to be three primary inter-jurisdictional problems associated with drainage issues that should be addressed:

1. Lack of consistent drainage and development standards;
2. Lack of consistent enforcement of these standards; and
3. Lack of resources to implement and enforce the standards.

8.1 City and County Legal Authority to Control Drainage

Preventing drainage problems is generally less costly than fixing the results of poorly thought out development decisions or lack of standards to guide development. The latitude afforded cities and counties in Texas is guided by and limited by state law as well as local policy. Generally, county discretion is limited and development standards are an important example of that limitation.

Counties in Texas have general statutory authority over platting of subdivisions and management of floodplain areas (under FEMA guidelines). Both of these tools can be used to manage some of the issues mentioned above. Where property has been formally platted, drainage easements reflecting either channels or swales should be included in plats and enforced at the county level. Some property is developed, however, without formal plats (usually for smaller parcels or where a family subdivides). In both cases, FEMA floodplain management rules can be invoked to prevent property owners from impacting drainage and enforced at the county level.

Border counties and cities have greater latitude to manage such development than non-border counties. A firm understanding of where El Paso County regulation (and El Paso County's municipal regulation authority) could be modified to address current issues and to prevent future problems is desirable. More options may be available to guide development and drainage regulation solutions than are currently being used.

With the passage of the Economically Distressed Areas Program (EDAP) in 1989 and subsequent amendments, the Texas Legislature gave certain cities and counties additional powers to regulate development. Drainage standards are included in those regulatory powers. The local government code (in Chapters 212 and 232) gives significantly greater authority to border counties, cities, and cities' extraterritorial jurisdiction areas (ETJs) to require additional standards for development. A legal review of these powers and duties is recommended so that both El Paso County and other municipalities in the County can fully understand the limits of their authorities, and target those powers to address, prevent, and mitigate costly drainage issues. Many of the potential solutions are dependent on this understanding being appropriately applied.

In addition, the Model Subdivision Rules (MSRs) (a requirement of the EDAP Legislation) only address drainage at a cursory level. This is not surprising given the driving forces behind the EDAP Legislation (water and sewer services in the state's *colonias*). However, integrating these two issues (water service and drainage) can lead to more satisfactory and sustainable solutions to what is ultimately a housing problem. Further clarification and emphasis of drainage requirements in the MSRs by the state agencies charged with developing and enforcing them, might add further substance to the limits and authorities of cities and counties with respect to development and drainage.

8.2 Potential Inter-Jurisdictional Authority to Control Drainage

As described previously, countywide clarification and, perhaps, additional regulation, is needed to address the fact that many drainage issues impact multiple jurisdictions within the County (cities and areas outside of any municipality). Addressing these issues will require a common set of standards and some way of integrating solutions in an appropriate manner. In addition to standards, an explicit policy to address these issues (both methodology and standards) should be developed. Such a goal can be achieved through formal agreements between communities.

8.3 Public Information Program

As the County addresses the various recommendations described above (and perhaps in coordination with others) it will likely find it desirable to develop a public information program to describe the intended new programs and actions, and their rationale to the local community. Many similar public information programs have been quite successful in Texas and these should be reviewed for “lessons learned.” The EPWU’s stormwater management and water conservation educational programs are good examples. There are many other examples of successful public information campaigns related to public infrastructure and related issues that could be used as the basis for an El Paso County effort.

8.4 Stormwater Management Information Resources

Information related to stormwater management at a number of jurisdictional levels is available on the internet. Although not all of these resources specifically pertain to the unincorporated portions of El Paso County, they provide information that can be utilized as guidance. Two resources in particular that provide beneficial information are listed below:

- The FEMA National Flood Insurance Program Website
Found at <http://www.fema.gov/plan/prevent/floodplain/index.shtm>, this website provides Federal information on floodplain management and contains links to Federal laws, FIRMS, and many additional floodplain management resources. The link for viewing FIRMS is <http://msc.fema.gov>.
- The City of El Paso Engineering Department Website
Found at <http://www.elpasotexas.gov/engineering>, this website provides information on flood zones in El Paso and contains a link to the City of El Paso DDM. The DDM provides guidance and criteria for design of stormwater conveyance within the City of El Paso.

9.0 REFERENCES

City of El Paso, Texas, 2008. City of El Paso Drainage Design Manual (DDM).

El Paso County, 2007. Study of Rural Homesites Deemed at Risk of Flooding by 100-Year Flood.

Federal Emergency Management Agency (FEMA), 2005. Updated Flood Insurance Rate Maps (FIRMs) and Flood Insurance Study (FIS).

Half Associates, 2009. Interview to discuss ongoing Clint Landfill analysis.

International Boundary and Water Commission (IBWU), February 2007. Development of Alternatives for Canutillo Flood Control Improvements, Rio Grande Canalization Project.

Parkhill, Smith, & Cooper, Inc. (PSC), 2009. Interview with Matt Dyer from PSC to discuss Clint Landfill drainage scenario.

Texas Department of Transportation (TxDOT), 2004. 2004 Topography.

URS Corporation (URS) and Moreno Cardenas Inc. (MCi), March 2009. City of El Paso Stormwater Master Plan (SMP).

URS, 2009. Interviews with El Paso County.

URS, 2008. El Paso Drainage Design Manual (DDM).

US Army Corps of Engineers (USACE), 2004 - 2007. Sparks Arroyo Flood Control Project.

U.S. Department of Agriculture (USDA), Natural Resources Conservation Service (NRCS), 2004. Soil Survey Geographic Database (SSURGO) Soil Database for El Paso County, Texas.

USDA, Soil Conservation Service (SCS), 1986. Technical Release 55 (TR-55) Urban Hydrology for Small Watersheds.

APPENDIX A
HYDROLOGY REPORT

This page was intentionally left blank.

TABLE OF CONTENTS

<u>Section</u>		<u>Page</u>
A.1.0	BACKGROUND	1
A.2.0	DATA SOURCES	3
A.3.0	WATERSHED DELINEATION	5
A.3.1	Method Overview.....	5
A.3.2	Watershed Delineation - Vinton Study Area	5
A.3.3	Watershed Delineation - Canutillo Study Area	5
A.3.4	Watershed Delineation - Socorro Study Area.....	5
A.3.5	Watershed Delineation - Hacienda Real Study Area	5
A.3.6	Watershed Delineation - Fabens Study Area	6
A.3.7	Watershed Delineation - Tornillo Study Area.....	6
A.4.0	CURVE NUMBER ESTIMATION	7
A.4.1	Method Overview.....	7
A.4.2	Curve Number Estimation - Vinton Study Area	7
A.4.3	Curve Number Estimation - Canutillo Study Area.....	8
A.4.4	Curve Number Estimation - Socorro Study Area	8
A.4.5	Curve Number Estimation - Hacienda Real Study Area	8
A.4.6	Curve Number Estimation - Fabens Study Area.....	8
A.4.7	Curve Number Estimation - Tornillo Study Area.....	8
A.5.0	LAG TIME ESTIMATION	9
A.5.1	Method Overview.....	9
A.5.2	Lag Time Estimation - Vinton Study Area.....	9
A.5.3	Lag Time Estimation - Canutillo Study Area	10
A.5.4	Lag Time Estimation - Socorro Study Area	10
A.5.5	Lag Time Estimation - Hacienda Real Study Area	10
A.5.6	Lag Time Estimation - Fabens Study Area	10
A.5.7	Lag Time Estimation - Tornillo Study Area	10
A.6.0	HYDROLOGIC ROUTING	11
A.6.1	Method Overview.....	11
A.6.2	Hydrologic Routing - Vinton Study Area	11
A.6.3	Hydrologic Routing - Canutillo Study Area	11
A.6.4	Hydrologic Routing - Socorro Study Area.....	11
A.6.5	Hydrologic Routing - Hacienda Real Study Area	12
A.6.6	Hydrologic Routing - Fabens Study Area	12
A.6.7	Hydrologic Routing - Tornillo Study Area.....	12
A.7.0	MODELING OF SIGNIFICANT DETENTION STRUCTURES.....	13
A.7.1	Method Overview.....	13
A.7.2	Significant Detention Structures - Vinton Study Area	13

A.7.3	Significant Detention Structures - Canutillo Study Area.....	13
A.7.4	Significant Detention Structures - Socorro Study Area.....	13
A.7.5	Significant Detention Structures - Hacienda Real Study Area.....	13
A.7.6	Significant Detention Structures - Fabens Study Area.....	13
A.7.7	Significant Detention Structures - Tornillo Study Area.....	14
A.8.0	SMALL PONDS	15
A.8.1	Method Overview.....	15
A.8.2	Small Ponds - Vinton Study Area	15
A.8.3	Small Ponds - Canutillo Study Area.....	15
A.8.4	Small Ponds - Socorro Study Area	15
A.8.5	Small Ponds - Hacienda Real Study Area	16
A.8.6	Small Ponds - Fabens Study Area.....	16
A.8.7	Small Ponds - Tornillo Study Area.....	16
A.9.0	ESTIMATION OF RAINFALL.....	17
A.10.0	ASSEMBLY OF HYDROLOGIC MODELS	19
A.10.1	Method Overview.....	19
A.10.2	Hydrologic Model - Vinton Study Area.....	19
A.10.3	Hydrologic Model - Canutillo Study Area	19
A.10.4	Hydrologic Model - Socorro Study Area	20
A.10.5	Hydrologic Model - Hacienda Real Study Area	20
A.10.6	Hydrologic Model - Fabens Study Area.....	20
A.10.7	Hydrologic Model - Tornillo Study Area	21
A.11.0	MODEL RESULTS	23

LIST OF TABLES

Table A-1	Data Sources Utilized in Hydrologic Analysis	27
Table A-2	Hydrologic Soil Groups in the El Paso Region.....	28
Table A-3	Runoff Curve Numbers for Urban Areas.....	29
Table A-4	Runoff Curve Numbers for Arid and Semi Arid Rangelands.....	29
Table A-5	Runoff Curve Numbers for Agricultural Lands	30
Table A-6	Land Use Categories for Urban Areas.....	30
Table A-7	Land Use Categories for Rural Areas	31
Table A-8	Curve Number Summary for Vinton Study Area	31
Table A-9	Curve Number Summary for Canutillo Study Area	31
Table A-10	Curve Number Summary for Socorro Study Area.....	32
Table A-11	Curve Number Summary for Hacienda Real Study Area.....	33
Table A-12	Curve Number Summary for Fabens Study Area	34
Table A-13	Curve Number Summary for Tornillo Study Area.....	34
Table A-14	Summary of Lag Times for Vinton Study Area.....	35
Table A-15	Summary of Lag Times for Canutillo Study Area	35
Table A-16	Summary of Lag Times for Socorro Study Area	36

Table A-17	Summary of Lag Times for Hacienda Real Study Area	37
Table A-18	Summary of Lag Times for Fabens Study Area	39
Table A-19	Summary of Lag Times for Tornillo Study Area	40
Table A-20	Muskingum-Cunge Routing Inputs for Vinton Study Area.....	41
Table A-21	Muskingum-Cunge Routing Inputs for Canutillo Study Area.....	43
Table A-22	Muskingum-Cunge Routing Inputs for Socorro Study Area	45
Table A-23	Muskingum-Cunge Routing Inputs for Hacienda Real Study Area	47
Table A-24	Muskingum-Cunge Routing Inputs for Fabens Study Area.....	49
Table A-25	Muskingum-Cunge Routing Inputs for Tornillo Study Area	53
Table A-26	Adjusted Areas for Socorro Study Area	55
Table A-27	Adjusted Curve Numbers for Socorro Study Area	55
Table A-28	Adjusted Areas for Hacienda Real Study Area	56
Table A-29	Estimation of Rainfall Depth by Annual Exceedance Probability	57
Table A-30	Complete HEC-HMS Results for 100-Year Storm - Vinton Study Area....	58
Table A-31	Complete HEC-HMS Results for 100-Year Storm - Canutillo Study Area	58
Table A-32	Complete HEC-HMS Results for 100-Year Storm - Socorro Study Area	59
Table A-33	Complete HEC-HMS Results for 100-Year Storm - Hacienda Real Study Area.....	61
Table A-34	Complete HEC-HMS Results for 100-Year Storm - Fabens Study Area	65
Table A-35	Complete HEC-HMS Results for 100-Year Storm - Tornillo Study Area	66

LIST OF FIGURES

Figure A-1	Master Plan Study Areas	69
Figure A-2	Watershed Delineation - Vinton Study Area.....	70
Figure A-3	Watershed Delineation - Canutillo Study Area.....	71
Figure A-4	Watershed Delineation – Socorro Study Area	72
Figure A-5	Watershed Delineation – Hacienda Real Study Area	73
Figure A-6	Watershed Delineation - Fabens Study Area.....	74
Figure A-7	Watershed Delineation - Tornillo Study Area.....	75
Figure A-8	Hydrologic Soil Groups Map - Vinton Study Area	76
Figure A-9	Land Use Map - Vinton Study Area	77
Figure A-10	Hydrologic Soil Groups Map - Canutillo Study Area	78
Figure A-11	Land Use Map - Canutillo Study Area.....	79
Figure A-12	Hydrologic Soil Groups Map – Socorro Study Area	80
Figure A-13	Land Use Map – Socorro Study Area	81
Figure A-14	Hydrologic Soil Groups Map – Hacienda Real Study Area	82
Figure A-15	Land Use Map – Hacienda Real Study Area	83
Figure A-16	Hydrologic Soil Groups Map - Fabens Study Area	84
Figure A-17	Land Use Map - Fabens Study Area.....	85
Figure A-18	Hydrologic Soil Groups Map - Tornillo Study Area.....	86

Figure A-19	Land Use Map - Tornillo Study Area	87
Figure A-20	Longest Flowpaths - Vinton Study Area	88
Figure A-21	Longest Flowpaths - Canutillo Study Area	89
Figure A-22	Longest Flowpaths – Socorro Study Area.....	90
Figure A-23	Longest Flowpaths – Hacienda Real Study Area.....	91
Figure A-24	Longest Flowpaths - Fabens Study Area	92
Figure A-25	Longest Flowpaths - Tornillo Study Area	93
Figure A-26	Routing Reaches - Vinton Study Area	94
Figure A-27	Routing Reaches - Canutillo Study Area.....	95
Figure A-28	Routing Reaches – Socorro Study Area	96
Figure A-29	Routing Reaches – Hacienda Real Study Area	97
Figure A-30	Routing Reaches - Fabens Study Area	98
Figure A-31	Routing Reaches - Tornillo Study Area.....	99
Figure A-32	Location Map - Modeled Existing Detention Structures	100
Figure A-33	Location Map - Small Ponds	101
Figure A-34	HEC-HMS Model Layout - Vinton Study Area.....	102
Figure A-35	HEC-HMS Model Table - Canutillo Study Area.....	103
Figure A-36	HEC-HMS Model Layout – Socorro Study Area	104
Figure A-37	HEC-HMS Model Table – Hacienda Real Study Area	105
Figure A-38	HEC-HMS Model Layout - Fabens Study Area.....	106
Figure A-39	HEC-HMS Model Table - Tornillo Study Area.....	107

A.1.0 BACKGROUND

A hydrologic analysis was performed for the study areas identified in *The Study of Rural Homesites Deemed at Risk of Flooding by the 100-Year Flood* (El Paso County, 2007) to estimate peak storm flows that would occur for extreme storm events. The analysis consisted of the following steps:

- Watersheds boundaries were delineated;
- Curve Numbers were estimated for each watershed;
- Lag Times were estimated for each watershed;
- Routing parameters were estimated for each flowpath;
- Large detention structures were analyzed;
- The effect of small ponds was analyzed;
- Precipitation was estimated; and
- Hydrologic models were developed for each study area.

Detailed descriptions of the steps, assumptions, and results of the analysis are presented in this Appendix. Summaries of pertinent data, calculations, tables, and figures are located at the end of this Appendix. An overview of the project area is provided on Figure A-1.

Hydrologic analysis for the Sparks Arroyo and Sub Basin A Study Area was performed by the U.S. Army Corp of Engineers (USACE) as part of an ongoing feasibility study. URS Corporation (URS) used data from the USACE hydrologic analysis for this Stormwater Master Plan (SMP), and did not perform a separate hydrologic analysis for this study area as discussed above.

This page was intentionally left blank.

A.2.0 DATA SOURCES

Table A-1 lists the sources used in the hydrologic analysis, as well as the specific calculation(s) each source was used for.

This page was intentionally left blank.

A.3.0 WATERSHED DELINEATION

A.3.1 Method Overview

Watershed boundaries were delineated for much of the El Paso County SMP (hereafter referred to as the County SMP) study area based on 3-foot contours generated from the Texas Department of Transportation (TxDOT) 2004 Topography (TxDOT, 2004). ArcView was utilized to digitize the watershed boundaries for use in hydrologic analysis. This analysis was used to estimate hydrologic flows for the existing condition at the downstream end of identified study reaches, as well as at key crossings and existing dam locations. Each watershed polygon was assigned a unique name based on the element or primary flow path that the watershed contributed to. Successive watersheds contributing to the same flow path were labeled with a number at the end of the name, increasing in the upstream direction.

A.3.2 Watershed Delineation - Vinton Study Area

Watersheds for the Vinton Study Area were digitized as described above, utilizing the 2004 Topography (TxDOT, 2004) and the 2008 El Paso County Orthophotography (El Paso County, 2008). Where available, watershed delineations from the City of El Paso SMP (hereafter referred to as the City SMP) were used. The analyzed drainage area consisted of 25.3 square miles and was delineated into 39 watersheds. Figure A-2 shows the watershed delineations for the Vinton Study Area.

A.3.3 Watershed Delineation - Canutillo Study Area

Watersheds for the Canutillo Study Area were digitized as described above, utilizing the 2004 Topography (TxDOT, 2004) and the 2008 Orthophotography (El Paso County, 2008). Where available, watershed delineations from the Federal Emergency Management Agency (FEMA) update and analysis of the Flood Insurance Rate Maps (FIRMs) and Flood Insurance Study (FIS) for El Paso County were used. The analyzed drainage area consisted of 3.1 square miles and was delineated into eight watersheds. Figure A-3 shows the watershed delineations for the Canutillo Study Area.

A.3.4 Watershed Delineation - Socorro Study Area

Watersheds for the Socorro Study Area were digitized as described above, utilizing the 2004 Topography (TxDOT, 2004) and the 2008 Orthophotography (El Paso County, 2008). The analyzed drainage area consisted of 7.6 square miles and was delineated into 15 watersheds. Figure A-4 shows the watershed delineations for the Socorro Study Area.

A.3.5 Watershed Delineation - Hacienda Real Study Area

Watersheds for the Hacienda Real Study Area were digitized as described above, utilizing the 2004 Topography (TxDOT, 2004) and the 2008 Orthophotography (El Paso County, 2008). The analyzed drainage area consisted of 25.3 square miles and was delineated into 39 watersheds. Figure A-5 shows the watershed delineations for the Hacienda Real Study Area.

A.3.6 Watershed Delineation - Fabens Study Area

Watersheds for the Fabens Study Area were digitized as described above, utilizing the 2004 Topography (TxDOT, 2004) and the 2008 Orthophotography (El Paso County, 2008). Where available, watershed delineations from the FEMA update and analysis of the FIRMs and FIS for El Paso County were used and modified as necessary to cover the differences in study area and limits. The analyzed drainage area consisted of 26.5 square miles and was delineated into 14 watersheds. Figure A-6 shows the watershed delineations for the Fabens Study Area.

A.3.7 Watershed Delineation - Tornillo Study Area

Watersheds for the Tornillo Study Area were digitized as described above, utilizing the 2004 Topography (TxDOT, 2004) and the 2008 Orthophotography (El Paso County, 2008). The analyzed drainage area consisted of 3.1 square miles and was delineated into 12 watersheds. Figure A-7 shows the watershed delineations for the Tornillo Study Area.

A.4.0 CURVE NUMBER ESTIMATION

A.4.1 Method Overview

Runoff losses were modeled in Hydrologic Engineering Center's Hydrologic Modeling System (HEC-HMS) by selecting the Soil Conservation Service (SCS) Curve Number Loss Method. This method requires the user to input the SCS Curve Number, percent impervious cover, and initial abstraction. SCS Type II Curve Numbers were assigned based on the combination of hydrologic soil groups (HSGs) and land use cover description according to the El Paso Drainage Design Manual (DDM), Tables 4-9 and 4-10 (City of El Paso, June 2008); which are summarized in Tables A-3, A-4, and A-5.

When entering the curve number parameters into the HEC-HMS Model, the percent impervious cover was left as 0 percent (%) because it is already accounted for in the Curve Number Calculation Method described below. The initial abstraction parameter defines the amount of rainfall that must fall before surface runoff occurs. This value was left blank, and by default, HEC-HMS calculates it as 0.2 times the potential retention.

HSGs were determined using the soil type shapefile for El Paso County available from the Soil Survey Geographic Database (SSURGO) (United States Department of Agriculture [USDA], 2004). The SSURGO soil shapefile delineates soil according to soil types, which were correlated to HSG based on a key code also available from SSURGO, summarized in Table A-2. Soils were classified as soil group A, B, C, D, water, or sink. Sinks are areas such as landfills or quarries that collect water and are thus not included in runoff calculations.

Land use types were estimated using 2008 Orthophotography (El Paso County, 2008) and delineated in ArcView. Polygons were digitized according to the land use cover categories provided in the DDM (City of El Paso, June 2008). Each polygon was assigned a land use cover type text attribute and a land use identification (ID) numerical attribute corresponding to Tables A-6 and A-7 at the end of this Appendix.

A curve number shapefile was created by combining the land use and soils shapefiles using the ArcView Union tool. Curve numbers were then assigned according to the DDM (City of El Paso, June 2008) for each soil group-land use combination. Finally, a union was created between the curve number shapefile and the watershed boundary shapefile, and the area-weighted average curve number for each watershed was calculated using the following equation:

$$CN_{avg} = \frac{\sum Area \times CN}{\sum Area \text{ Sum}}$$

A.4.2 Curve Number Estimation - Vinton Study Area

Curve numbers for the portion of the Vinton Study Area not previously analyzed in the City SMP were estimated as described above. Hydrologic analysis was not completed

for Flow Path Number 45 and Flow Path Number 45A watersheds as part of the County SMP, as it was completed as part of the City SMP. Results of the curve number estimation are provided in Table A-8. A map of soil types is provided on Figure A-8, and a map showing land use categories delineated is provided on Figure A-9, found at the end of this Appendix.

A.4.3 Curve Number Estimation - Canutillo Study Area

Curve numbers for the Canutillo Study Area were estimated as described above. The results of the curve number estimation are provided in Table A-9. A map of soil types is provided on Figure A-10, and a map showing land use categories delineated is provided on Figure A-11, found at the end of this Appendix.

A.4.4 Curve Number Estimation - Socorro Study Area

Curve numbers for the Socorro Study Area were estimated as described above. The results of the curve number estimation are provided in Table A-10. A map of soil types is provided on Figure A-12, and a map showing land use categories delineated is provided on Figure A-13, found at the end of this Appendix.

A.4.5 Curve Number Estimation - Hacienda Real Study Area

Curve numbers for the Hacienda Real Study Area were estimated as described above. The results of the curve number estimation are provided in Table A-11. A map of soil types is provided on Figure A-14, and a map showing land use categories delineated is provided on Figure A-15, found at the end of this Appendix.

A.4.6 Curve Number Estimation - Fabens Study Area

Curve numbers for the Fabens Study Area were estimated as described above. The results of the curve number estimation are provided in Table A-12. A map of soil types is provided on Figure A-16, and a map showing land use categories delineated is provided on Figure A-17, found at the end of this Appendix.

A.4.7 Curve Number Estimation - Tornillo Study Area

Curve numbers for the Tornillo Study Area were estimated as described above. The results of the curve number estimation are provided in Table A-13. A map of soil types is provided on Figure A-18, and a map showing land use categories delineated is provided on Figure A-19, found at the end of this Appendix.

A.5.0 LAG TIME ESTIMATION

A.5.1 Method Overview

The lag time was calculated for each modeled watershed using the modified Snyder Method developed for the FIS for Northeast and Central El Paso conducted by the USACE in 1978 (USACE, February 1978). The methodology for the Snyder calculation is shown below:

$$T_{lag} = C_T (L_L * L_{CA})^{0.3}$$

where: T_{lag} = Lag Time (hrs);
 C_T = Regional Coefficient (Plate A-3, USACE, February 1978);
 L_L = Length of longest flow path (mi);
 L_{CA} = Length from longest flow path centroid to outlet of watershed (mi).

The regional coefficient, C_T , was estimated according to equivalent slope based on the curves for undeveloped areas and urban areas found in Plate A3 of the USACE 1978 Report (USACE, February 1978). Equivalent slope was assumed to be the slope between the 10% and 85% marker elevations, traveling upstream along the longest flow path.

The Snyder peaking coefficient, c_p , was defined according to the following guidelines:

$$640c_p = 430 \text{ if } slope\left(\frac{ft}{ft}\right) < 0.015$$

$$640c_p = 392 \text{ if } slope\left(\frac{ft}{ft}\right) > 0.015$$

The longest flowpath was digitized by referencing the 2004 Topography (TxDOT, 2004). A polyline was created in ArcView connecting the farthest upstream point in the watershed to the watershed outlet, while following a path of decreasing elevation. Physical barriers that were visible in the 2008 Orthophotography (El Paso County, 2008) were taken into account while estimating the longest flow path for each watershed.

A.5.2 Lag Time Estimation - Vinton Study Area

Lag Times for the Vinton Study Area were estimated using the method described above and are summarized in Table A-14. Longest flowpaths for the Vinton Study Area are shown on Figure A-20 located at the end of this Appendix. Lag time estimation was not completed for Flow Path Number 45 and Flow Path Number 45A watersheds as part of the County SMP, as it was completed as part of the City SMP.

A.5.3 Lag Time Estimation - Canutillo Study Area

Lag Times for the Canutillo Study Area were estimated using the method described above and are summarized in Table A-15. Longest flowpaths for the Canutillo Study Area are shown on Figure A-21 located at the end of this Appendix.

A.5.4 Lag Time Estimation - Socorro Study Area

Lag Times for the Socorro Study Area were estimated using the method described above and are summarized in Table A-16. Longest flowpaths for the Socorro Study Area are shown on Figure A-22 located at the end of this Appendix.

A.5.5 Lag Time Estimation - Hacienda Real Study Area

Lag Times for the Hacienda Real Study Area were estimated using the method described above and are summarized in Table A-17. Longest flowpaths for the Hacienda Real Study Area are shown on Figure A-23 located at the end of this Appendix.

A.5.6 Lag Time Estimation - Fabens Study Area

Lag Times for the Fabens Study Area were estimated using the method described above and are summarized in Table A-18. Longest flowpaths for the Fabens Study Area are shown on Figure A-24 located at the end of this Appendix.

A.5.7 Lag Time Estimation - Tornillo Study Area

Lag Times for the Tornillo Study Area were estimated using the method described above and are summarized in Table A-19. Longest flowpaths for the Tornillo Study Area are shown on Figure A-25 located at the end of this Appendix.

A.6.0 HYDROLOGIC ROUTING

A.6.1 Method Overview

Once watershed delineations were completed, flowpaths were identified and the HEC-HMS model was constructed. A routing shapefile was digitized in ArcView containing the reaches corresponding to the HEC-HMS Model. When generating the routing schematic, the assumption was made that flow would be conveyed along the drainage infrastructure and would not be diverted due to insufficient capacity and overtopping. The HEC-HMS Muskingum-Cunge Method of routing was selected for all open channel reaches. In this method, the user first enters the channel shape. If “trapezoid” is selected, the user enters a channel slope, a Manning’s roughness coefficient, and a channel bottom width. If “eight point” is selected, then the X-Y coordinates (station-elevation) for the channel cross-section are entered into the paired-data editor, along with the Manning’s roughness coefficient.

Several data sources were available for the estimation of cross-section geometry. The first source utilized was site visit measurements. Additional survey performed at crossings was utilized to more accurately estimate channel geometry and verify site visit measurements. Where no more reliable data was available, the 2004 Topography (TxDOT, 2004) was used along with the 2008 Orthophotography (El Paso County, 2008).

A.6.2 Hydrologic Routing - Vinton Study Area

Routing for the Vinton Study Area open channels and arroyos was estimated using the method described above. For natural arroyos, no site visit measurements or survey were available, so routing dimensions were based solely on the 2004 Topography (TxDOT, 2004) and the 2008 Orthophotography (El Paso County, 2008). Channel routing inputs for the Vinton Study Area are provided in Table A-20. Figure A-26 shows the routing reaches for the Vinton Study Area. Hydrologic analysis was not completed for Flow Path Number 45 and Flow Path Number 45A watersheds as part of the County SMP, as it was completed as part of the City SMP.

A.6.3 Hydrologic Routing - Canutillo Study Area

Routing for the Canutillo Study Area open channels and arroyos was estimated using the method described above. For natural arroyos, no site visit measurements or survey were available, so routing dimensions were based solely on the 2004 Topography (TxDOT, 2004) and the 2008 Orthophotography (El Paso County, 2008). Channel routing inputs for the Canutillo Study Area are provided in Table A-21. Figure A-27 shows the routing reaches for the Canutillo Study Area.

A.6.4 Hydrologic Routing - Socorro Study Area

Routing for the Socorro Study Area open channels and arroyos was estimated using the method described above. For natural arroyos, no site visit measurements or survey

were available, so routing dimensions were based solely on the 2004 Topography (TxDOT, 2004) and the 2008 Orthophotography (El Paso County, 2008). Channel routing inputs for the Socorro Study Area are provided in Table A-22. Figure A-28 shows the routing reaches for the Socorro Study Area.

A.6.5 Hydrologic Routing - Hacienda Real Study Area

Routing for the Hacienda Real Study Area open channels and arroyos was estimated using the method described above. For natural arroyos, no site visit measurements or survey were available, so routing dimensions were based solely on the 2004 Topography (TxDOT, 2004) and the 2008 Orthophotography (El Paso County, 2008). Channel routing inputs for the Hacienda Real Study Area are provided in Table A-23. Figure A-29 shows the routing reaches for the Hacienda Real Study Area.

A.6.6 Hydrologic Routing - Fabens Study Area

Routing for the Fabens Study Area open channels and arroyos was estimated using the method described above. For natural arroyos, no site visit measurements or survey were available, so routing dimensions were based solely on the 2004 Topography (TxDOT, 2004) and the 2008 Orthophotography (El Paso County, 2008). Channel routing inputs for the Fabens Study Area are provided in Table A-24. Figure A-30 shows the routing reaches for the Fabens Study Area.

A.6.7 Hydrologic Routing - Tornillo Study Area

Routing for the Tornillo Study Area open channels and arroyos was estimated using the method described above. For natural arroyos, no site visit measurements or survey were available, so routing dimensions were based solely on the 2004 Topography (TxDOT, 2004) and the 2008 Orthophotography (El Paso County, 2008). Channel routing inputs for the Tornillo Study Area are provided in Table A-25. Figure A-31 shows the routing reaches for the Tornillo Study Area.

A.7.0 MODELING OF SIGNIFICANT DETENTION STRUCTURES

A.7.1 Method Overview

Significant detention structures were modeled in HEC-HMS using a stage-area-discharge relationship.

A stage-area-discharge relationship was developed for each existing basin. The relationship dictated how the upstream flow was attenuated by the reservoirs and associated dam structures. The relationship consists of a stage elevation (ft) versus a corresponding reservoir surface area (acres) and a dam discharge (cfs), starting at the bottom elevation of the dam's storage reservoir and increasing to the top elevation of the dam embankment. This relationship is defined by the components of the dam, its storage basin, its embankment size and height, and its outflow structures. Reservoirs without outflow structures were assumed to hold flow until the structure overtopped.

Dams identified by the County and consisting of outflow structures were modeled in the Water Resources Site Analysis Program (SITES), which used information from survey data obtained by the County, TxDOT Contours (TxDOT, 2004) and the 2008 Orthophotography (El Paso County, 2008). The total stage-area-discharge table produced by SITES was the input used to model the dams in HEC-HMS for this study.

A.7.2 Significant Detention Structures - Vinton Study Area

There are no existing significant detention structures modeled in the Vinton Study Area.

A.7.3 Significant Detention Structures - Canutillo Study Area

There are no existing significant detention structures modeled in the Canutillo Study Area.

A.7.4 Significant Detention Structures - Socorro Study Area

There are no existing significant detention structures modeled in the Socorro Study Area.

A.7.5 Significant Detention Structures - Hacienda Real Study Area

There are no existing significant detention structures modeled in the Hacienda Real Study Area.

A.7.6 Significant Detention Structures - Fabens Study Area

Six existing detention structures are within the Fabens Study Area. The analysis of each structure used the process described above. The location and stage-area-discharge was determined in ArcView using available survey data, 2004 Topography (TxDOT, 2004) and the 2008 Orthophotography (El Paso County, 2008). SITES was

utilized to determine the total stage-area-discharge table to input into HEC-HMS for three of the six structures. SITES was not utilized for the existing structures that are located at the downstream end of Fabens North 1 and along San Felipe Arroyo.

The SITES program was used to generate the total stage-area-discharge tables for Roberts Tank, Rattlesnake Lake, and Dam Number 6. Outlet information and survey provided by the County, and ArcView information described above, was used for the necessary input data required by the SITES program. The three basins that SITES was not used for are Phelps Dodge Detention Basin, Fabens North 1, and Fabens Lake. Fabens Lake was analyzed during the FEMA update and analysis of the FIRMs and FIS for El Paso County. The data from this analysis was used for the HEC-HMS model. Fabens North 1 was modeled with no outflow structure using HEC-HMS as described above. CulvertMaster was used to determine the discharge rating curve of the outlet at Phelps Dodge Detention Basin. The basin outlet consists of four 8-inch PVC pipes. Due to the simplicity of the outlet, analysis within CulvertMaster was appropriate.

The locations of the existing structures are shown on Figure A-32 at the end of this Appendix.

A.7.7 Significant Detention Structures - Tornillo Study Area

Two existing detention structures are within the Tornillo Study Area. Each structure was analyzed using the method described above. The location and stage-storage-discharge relationship were determined in ArcView using available survey data, 2004 Topography (TxDOT, 2004) and the 2008 Orthophotography (El Paso County, 2008).

The locations of the existing structures are shown on Figure A-32 at the end of this Appendix.

A.8.0 SMALL PONDS

A.8.1 Method Overview

In addition to the significant detention structures described in Section A.7.0, some study areas contain several small ponds that would contribute little to no runoff in the 100-year design storm. These ponds are too small, too numerous, and without sufficient information to incorporate into the existing condition model as reservoirs. To account for these ponds, the total ponding area was removed from the total contributing watershed area.

The location of each pond was determined in ArcView using the 2008 Orthophotography (El Paso County, 2008) and is shown on Figure A-33 at the end of this Appendix.

A.8.2 Small Ponds - Vinton Study Area

There are no small ponds to be accounted for in the Vinton Study Area.

A.8.3 Small Ponds - Canutillo Study Area

There are no small ponds to be accounted for in the Canutillo Study Area.

A.8.4 Small Ponds - Socorro Study Area

Areas were adjusted for 7 of the 15 watersheds in the Socorro Study Area due to the capacity provided by the small ponds not modeled as reservoirs in HEC-HMS. The adjusted watershed areas are provided in Table A-26 at the end of this Appendix.

In addition to the ponds accounted for in the area reduction, there were a number of retention ponds located within the El Paso Hills development. It was determined that reducing the watershed area to account for these ponds would not accurately represent the volume retained by them. For these ponds, the storage provided was accounted for by a reduction in the SCS Curve Number as described below.

The location of each pond was determined in ArcView, using 2008 Orthophotography (El Paso County, 2008). The 2004 Topography (TxDOT, 2004) data was used to estimate the volume of each pond.

Using the 100-year precipitation depth from the HEC-HMS model and the initial curve number as calculated in Section A.4.0, the watershed runoff was calculated using the following formulas:

$$Q = \frac{(P - 0.2 * S)^2}{(P + 0.8 * S)} \text{ and } S = \frac{1000}{CN} - 10$$

where:

- Q = Calculated runoff (inches)
- P = Precipitation (inches)
- CN = Curve Number

The runoff depth obtained from the initial HEC-HMS run was then adjusted to account for the storage provided by the small ponds within each watershed. The total depth of storage over the watershed was divided by the watershed area to estimate depth of runoff that would potentially be captured. This number was then subtracted from the depth of runoff obtained from the initial run of the HEC-HMS Model with the unadjusted curve numbers to obtain the depth of runoff that might occur with the pond storage accounted for. The curve numbers were then back-calculated using this modified runoff value per the above equations.

Curve numbers were adjusted for two watersheds in the Socorro Study Area due to the capacity provided by the retention ponds not modeled as reservoirs in HEC-HMS. The adjusted curve numbers for the Socorro Study Area are provided in Table A-27 at the end of this Appendix.

A.8.5 Small Ponds - Hacienda Real Study Area

Areas were adjusted for 8 of the 39 watersheds in the Hacienda Real Study Area due to the capacity provided by the small ponds not modeled as reservoirs in HEC-HMS. The adjusted watershed areas are provided in Table A-28 at the end of this Appendix.

A.8.6 Small Ponds - Fabens Study Area

There are no small ponds to be accounted for in the Fabens Study Area.

A.8.7 Small Ponds - Tornillo Study Area

There are no small ponds to be accounted for in the Tornillo Study Area.

A.9.0 ESTIMATION OF RAINFALL

Precipitation was estimated utilizing the “Frequency Storm” function in HEC-HMS along with the depth-duration-frequency data located in Tables 4-1 through 4-3 of the El Paso DDM (City of El Paso, June 2008). Using this method, the user enters the depth of rainfall that occurs for various durations for a given storm. Additional inputs required include the intensity duration, the storm duration, and intensity position.

El Paso rainfall totals are provided in Table A-29.

This page was intentionally left blank.

A.10.0 ASSEMBLY OF HYDROLOGIC MODELS

A.10.1 Method Overview

Hydrologic models were developed for each of the six study areas. These models contained the following elements representing the major contributing drainage features of the project area:

- Watershed Area;
- Flow Diversion;
- Junction;
- Routing Reach; and
- Dam/Basin/Sump.

The specific approaches and assumptions used to model the various elements can be found in the individual study area descriptions.

A.10.2 Hydrologic Model - Vinton Study Area

The Vinton Study Area HEC-HMS model consists of four watershed areas, two junctions, two reaches, and one sink. There are two natural arroyos modeled in this study area. The arroyos are Flow Path Number 44 and Flow Path Number 43. A sink was placed at the outlet of the arroyos to represent the convergence with the Rio Grande. Hydrologic analysis was not completed for Flow Path Number 45 and Flow Path Number 45A watersheds as part of the County SMP, as it was completed as part of the City SMP.

The Vinton Study Area HEC-HMS model schematic is shown on Figure A-34 at the end of this Appendix. Additionally, tables are provided listing model elements and 100-year flow results.

A.10.3 Hydrologic Model - Canutillo Study Area

The Canutillo Study Area HEC-HMS model consists of eight watershed areas, five junctions, four reaches, and two sinks (used to model existing basin endpoint and system outlet to the Rio Grande). There are five natural arroyos and one concrete lined channel modeled in this study area. The natural arroyos are Flow Path Number 42, Flow Path Number 42A, Flow Path Number 42B, Flow Path Number 42C, and Flow Path Number 42D. The concrete lined channel was unnamed and was designated First Avenue Channel for the purposes of the County SMP. There are no existing detention or retention basins located in the Canutillo Study Area.

The Canutillo Study Area HEC-HMS model schematic is shown on Figure A-35 at the end of this Appendix. Additionally, tables are provided listing model elements and 100-year flow results.

A.10.4 Hydrologic Model - Socorro Study Area

The Socorro Study Area HEC-HMS model consists of 15 watershed areas, 9 junctions, and 16 reaches. There were three natural arroyos that were modeled in this study area. These arroyos are named Stream, Stream 5, and an unnamed arroyo that is designated as Stream 5.5 for the purposes of this County SMP. A portion of the Mesa Spur Drain is also located in the Socorro Study Area. This drain was not modeled because it was not identified as an issue during initial meetings with the County. This was confirmed through witness accounts during the initial site visits.

The Socorro Study Area HEC-HMS model schematic is shown on Figure A-36 at the end of this Appendix. Additionally, tables are provided listing model elements and 100-year flow results.

A.10.5 Hydrologic Model - Hacienda Real Study Area

The Hacienda Real Study Area HEC-HMS model consists of 39 watershed areas, 4 diversions, 26 junctions, 29 reaches, and 3 sinks (used to model existing basin storage). There were nine natural arroyos that were modeled in this study area. These arroyos are named Stream 6, Stream 7, Stream 8, Stream 9, Stream 10, Stream 11, Stream 12, Stream 13, and an unnamed arroyo that is designated as Stream 13.5 for the purposes of this County SMP. A portion of the Mesa Drain is also located in the Hacienda Real Study Area. This drain was not modeled because it was not identified as an issue during initial meetings with the County. This was confirmed through witness accounts during the initial site visits. The Clint Landfill was originally removed from the model because it was assumed that the landfill provided onsite detention sufficient to capture all runoff from within the landfill. Per information received from Parkhill Smith & Cooper (PSC), the majority of the ponds were actually only sized to retain the 25-year flood and have no outflow structures. Given this information, the Clint Landfill was incorporated back into the model and sinks were utilized to account for the known storage volumes. Ponds evident in aerials with no data provided were ignored and the model was run as if the full watershed contributing to that pond ran offsite.

The Hacienda Real Study Area HEC-HMS model schematic is shown on Figure A-37 at the end of this Appendix. Additionally, tables are provided listing model elements and 100-year flow results.

A.10.6 Hydrologic Model - Fabens Study Area

The Fabens Study Area HEC-HMS model consists of 14 watershed areas, 6 junctions, 9 reaches, 6 basins, and 1 sink. Five natural arroyos were modeled in this study area. These arroyos are San Felipe Arroyo and San Felipe Arroyo Trib. 1; three unnamed arroyos were designated Fabens North 1, Fabens North 2, and Fabens North 2 Trib. 1 for the purposes of the County SMP. The six existing detention structures were modeled as basins using the method described in Section A.7.0. A sink was used to model the outlet of the San Felipe Arroyo into the River Drain Canal.

The Fabens Study Area HEC-HMS model schematic is shown on Figure A-38 at the end of this Appendix. Additionally, tables are provided listing model elements and 100-year flow results.

A.10.7 Hydrologic Model - Tornillo Study Area

The Tornillo Study Area HEC-HMS model consists of 12 watershed areas, 6 junctions, 5 reaches, 2 basins, and 1 sink. There are seven natural arroyos modeled in this study area. These arroyos are all unnamed arroyos and have been designated as High School Channel, High School Channel Trib. 1, High School Channel Trib. 2, South High School Channel, Flow Path T, Tornillo Handle Channel 1, and Tornillo Handle Channel 2 for the purposes of this County SMP. There are two basins at the downstream end of High School Channel/South High School Channel and Flow Path T. Each existing basin was modeled in HEC-HMS to determine the structures' ability to contain the 100-year storm event volume. The flow from the defined channels designated as Tornillo Handle Channel 1 and Tornillo Handle Channel 2 currently flow to a natural low in the topography. This area was modeled as a sink to determine the amount of flow that needs to be controlled and contained in the area.

The Tornillo Study Area HEC-HMS model schematic is shown on Figure A-39 at the end of this Appendix. Additionally, tables are provided listing model elements and 100-year flow results.

This page was intentionally left blank.

A.11.0 MODEL RESULTS

Model results for each of the six regions studied can be found in Tables A-30 through A-35 located at the end of this Appendix. Figure numbers for the corresponding HEC-HMS schematics and element tables are provided as well.

This page was intentionally left blank.

TABLES

This page was intentionally left blank.

Table A-1. Data Sources Utilized in Hydrologic Analysis

Source	Used For
City of El Paso, 2008. El Paso Drainage Design Manual.	Precipitation
El Paso County, 2008. Orthophotography.	Watershed Delineation Curve Number Lag Time
ESRI ArcView, Version 9.2 (2006) and Version 9.3.1 (2009).	Watershed Delineation Curve Number Lag Time
Texas Department of Transportation (TxDOT), El Paso Office, 2004. Topography.	Watershed Delineation Lag Time
US Army Corps of Engineers (USACE), 2008. Hydrologic Engineering Center's Hydraulic Modeling System (HEC-HMS), V. 3.3.0.	HEC-HMS
USACE, September 2008. HEC-HMS Technical Reference Manual.	HEC-HMS
USACE - Albuquerque District, February 1978. Report on Hydrologic Investigations Flood Insurance Study (FIS) - Northeast and Central El Paso, Texas.	Lag Times
U.S. Department of Agriculture (USDA) National Resource Conservation Commission (NRCS), 2004. Soil Survey Geographic Database (SSURGO) Soil Data for El Paso County, Texas.	Curve Number
USDA Soil Conservation Service, Engineering Division, Technical Release 55 (TR-55), June 1986. Urban Hydrology for Small Watersheds.	Curve Number

Table A-2. Hydrologic Soil Groups in the El Paso Region

EL PASO HYDROLOGIC SOIL GROUPS		
Soil Type	Soil Abbreviation	HSG
Hueco-Wink association, hummocky	HW	C
Anapra silty clay loam	An	B
Brazito loamy fine sand	Br	A
Gila fine sandy loam	Ga	B
Gila loam	Gc	B
Glendale loam	Gd	B
Glendale silty clay loam	Ge	B
Glendale silty clay	Gs	B
Harkey loam	Ha	B
Harkey silty clay loam	Hk	B
Made land, gila soil material	Mg	B
Saneli silty clay loam	Sa	D
Saneli silty clay	Sc	D
Tigua silty clay	Tg	D
Vinton fine sandy loam	Vn	B
Turney-Berino association, undulating	TBB	B
Agustin association, undulating	AGB	B
Badlands	BA	D
Bluepoint association, rolling	BPC	A
Bluepoint gravelly association, rolling	BUC	A
Delnorte-Canutio association, undulating	DCB	D
Delnorte-Canutio association hilly	DCD	D
Dune land	DU	A
Igneous rock land	IG	D
Igneous rockland-Brewster association	IN	D
Rock outcrop-Lozier association	LM	D
Lozier association, hilly	LOD	D
Mimbres association, level	MBA	B
Pajarito association, level	PAA	B
Simona association, undulating	SMB	D
Wink association, level	WKA	B
Water	W	W
Urban land, sanitary landfill	SLF	SINK
Pits, gravel	GP	SINK

Source: U.S. Department of Agriculture (USDA), Natural Resources Conservation Service (NRCS), 2004. Soil Survey Geographic Database (SSURGO) Soil Database for El Paso County, Texas.

Table A-3. Runoff Curve Numbers for Urban Areas

Hydrologic Soil Group		A	B	C	D
Open Space	Poor	68	79	86	89
	Fair	49	69	79	84
	Good	39	61	74	80
Commercial and Business	NA	89	92	94	95
Industrial	NA	81	88	91	93
Residential (1/8 acre or less)	NA	77	85	90	92
Residential (1/4 acre)	NA	61	75	83	87
Residential (1/2 acre)	NA	54	70	80	85
Residential (1 acre)	NA	51	68	79	84
Newly graded areas	NA	77	86	91	94
Highway	NA	98	98	98	98

Source: U.S. Department of Agriculture (USDA), Soil Conservation Service (SCS), 1986. Technical Release 55 (TR-55) Urban Hydrology for Small Watersheds.

Table A-4. Runoff Curve Numbers for Arid and Semi Arid Rangelands

Hydrologic Soil Group		A	B	C	D
Herbaceous	Poor		80	87	93
	Fair		71	81	89
	Good		62	74	85
Oak-aspen	Poor		66	74	79
	Fair		48	57	63
	Good		30	41	48
Pinyon-juniper	Poor		75	85	89
	Fair		58	73	80
	Good		41	61	71
Sage-grass	Poor		67	80	85
	Fair		51	63	70
	Good		35	47	55
Desert Shrub	Poor	63	77	85	88
	Fair	55	72	81	86
	Good	49	68	79	84

Source: U.S. Department of Agriculture (USDA), Soil Conservation Service (SCS), 1986. Technical Release 55 (TR-55) Urban Hydrology for Small Watersheds.

Table A-5. Runoff Curve Numbers for Agricultural Lands

Hydrologic Soil Group		A	B	C	D
Straight Row Crops	Poor	72	81	88	91
	Good	67	68	85	89
Small Grain – Straight Row Crops	Poor	65	76	84	88
	Good	63	75	83	87
Pasture, grassland, or range-continuous forage for grazing	Poor	68	79	86	89
	Fair	49	69	79	84
	Good	39	61	74	80
Meadow		30	58	71	78
Brush – brush-weeds-grass mixture, with brush the major element	Poor	48	67	77	83
	Fair	35	56	70	77
	Good	30	48	65	73
Woods – grass combination (orchard or tree farm)	Poor	57	73	82	86
	Fair	43	65	76	82
	Good	32	58	72	79
Woods	Poor	45	66	77	83
	Fair	36	60	73	79
	Good	30	55	70	77
Farmsteads		59	74	82	86

Source: U.S. Department of Agriculture (USDA), Soil Conservation Service (SCS), 1986. Technical Release 55 (TR-55) Urban Hydrology for Small Watersheds.

Table A-6. Land Use Categories for Urban Areas

Land Use Description	Hydrologic Condition	Land Use ID
Open Space (lawns, parks, golf courses, cemeteries)	Poor (grass cover <50%)	1
	Fair (grass cover 50% to 75%)	2
	Good (grass cover >75%)	3
Commercial and Business	NA	10
Industrial	NA	20
Residential (1/8 acre or less, townhouses)	NA	30
Residential (1/4 acre)	NA	31
Residential (1 acre)	NA	33
Residential (2 acres)	NA	34
Newly graded areas (no vegetation, pervious area only)	NA	40
Highway	NA	99

Source: U.S. Department of Agriculture (USDA), Soil Conservation Service (SCS), 1986. Technical Release 55 (TR-55) Urban Hydrology for Small Watersheds.

Table A-7. Land Use Categories for Rural Areas

Land Use Cover Type	Hydrologic Condition	Land Use ID
Herbaceous: mixture of grass, weeds, and low-growing brush, with brush the minor element	Poor	50
	Fair	51
	Good	52
Oak-aspen: mountain brush mixture of oak brush, aspen, mountain mahogany, bitter brush, maple, and other brush	Poor	60
	Fair	61
	Good	62
Pinyon-juniper: pinyon, juniper, or both: grass understory	Poor	70
	Fair	71
	Good	72
Sagebrush with grass understory	Poor	80
	Fair	81
	Good	82
Desert shrub: major plants include saltbush, greasewood, creosote brush, black brush, bursage, palo verde, mesquite, and cactus	Poor	90
	Fair	91
	Good	92

Source: U.S. Department of Agriculture (USDA), Soil Conservation Service (SCS), 1986. Technical Release 55 (TR-55) Urban Hydrology for Small Watersheds.

Table A-8. Curve Number Summary for Vinton Study Area

Watershed Name	Basin ID	Watershed Area (mi ²)	Weighted Curve Number
Flow Path Number 43	FPN43_1	105.97	84
Flow Path Number 44	FPN44_1	8.87	70
Flow Path Number 44	FPN44_2	5.81	83
Flow Path Number 44	FPN44_3	178.82	84

Table A-9. Curve Number Summary for Canutillo Study Area

Watershed Name	Basin ID	Watershed Area (mi ²)	Weighted Curve Number
First Avenue Channel	FAC_1	31.78	78
Flow Path Number 42	FPN42_1	11.49	68
Flow Path Number 42	FPN42_2	10.88	78
Flow Path Number 42	FPN42_3	163.21	84
Flow Path Number 42A	FPN42A_1	1.12	88
Flow Path Number 42B	FPN42B_1	8.58	85
Flow Path Number 42C	FPN42C_1	22.38	85
Flow Path Number 42D	FPN42D_1	6.37	85

Table A-10. Curve Number Summary for Socorro Study Area

Watershed Name	Watershed Area (mi²)	Weighted Curve Number
A_Mesa Spur 4-1	0.45	63
A_Mesa Spur 4-2	0.11	61
A_Mesa Spur 5.5-1	0.91	63
A_Mesa Spur 5.5-2	0.32	58
A_Mesa Spur 5-1	0.08	68
A_Stream 4-1	0.21	66
A_Stream 4-2	0.44	60
A_Stream 4-2b	0.03	64
A_Stream 4-3A	1.93	76
A_Stream 4-3B	0.65	63
A_Stream 5.5-1	0.09	65
A_Stream 5.5-2	1.34	59
A_Stream 5-1	0.18	62
A_Stream 5-2	0.78	59
A_Stream 5-2a	0.11	62

Table A-11. Curve Number Summary for Hacienda Real Study Area

Watershed Name	Watershed Area (mi²)	Weighted Curve Number
A_Clint Landfill A	0.11	79
A_Clint Landfill B	0.32	85
A_Clint Landfill C	0.27	77
A_Clint Landfill D	0.28	75
A_Hacienda Real-1	1.82	62
A_Hacienda Real-2	0.18	67
A_Hacienda Real-3	0.51	65
A_Hacienda Real-4	0.63	62
A_Hacienda Real-5	0.42	65
A_Hacienda Real-6	0.64	61
A_Hacienda Real-7	0.27	64
A_Hacienda Real-8	1.99	59
A_Stream 10-1	0.08	58
A_Stream 10-2	0.06	57
A_Stream 11-1	0.41	57
A_Stream 11-2	0.11	55
A_Stream 12-1	0.16	57
A_Stream 12-2	0.87	68
A_Stream 12-3	0.03	64
A_Stream 12-4	0.38	59
A_Stream 13.5-1a	0.24	56
A_Stream 13.5-1b	0.46	57
A_Stream 13.5-2	0.04	64
A_Stream 13.5-3	0.53	55
A_Stream 13.5-4a	5.67	80
A_Stream 13.5-4b	0.49	63
A_Stream 13-1	0.02	65
A_Stream 13-2	0.38	57
A_Stream 6-1	0.34	64
A_Stream 6-2	0.51	56
A_Stream 7-1	0.25	57
A_Stream 7-2	0.08	64
A_Stream 7-3	0.47	58
A_Stream 7-4	4.91	78
A_Stream 8-1	0.04	57
A_Stream 8-2	0.29	57
A_Stream 8-3	0.64	68
A_Stream 9-1	0.24	57
A_Stream 9-2	0.14	55

Table A-12. Curve Number Summary for Fabens Study Area

Watershed Name	Basin ID	Watershed Area (mi²)	Weighted Curve Number
Fabens North 1	FN1_1	4.08	49
Fabens North 1	FN1_2	8.60	53
Fabens North 1	FN1_3	19.26	52
Fabens North 2	FN2_1	9.34	53
Fabens North 2	FN2_2	21.87	49
Fabens North 2 Trib 1	FN2T1_1	23.35	52
San Felipe Arroyo	SFA_1	60.07	59
San Felipe Arroyo	SFA_FL1	404.75	54
San Felipe Arroyo	SFA_FL2	59.34	52
San Felipe Arroyo	SFA_PDB	158.66	60
San Felipe Arroyo	SFA_RSL	79.31	59
San Felipe Arroyo	SFA_RT	89.43	64
San Felipe Arroyo Trib 1	SFAT1_1	118.22	63
San Felipe Arroyo Trib 1	SFAT1_D6	608.90	77

Table A-13. Curve Number Summary for Tornillo Study Area

Watershed Name	Basin ID	Watershed Area (mi²)	Weighted Curve Number
Flow Path T	FPT_1	22.15	51
Flow Path T	FPT_2	26.67	61
High School Channel	HSC_1	4.28	56
High School Channel	HSC_2	17.86	49
High School Channel	HSC_3	16.56	58
High School Channel Trib 1	HSCT1_1	6.48	55
High School Channel Trib 1	HSCT1_2	17.34	67
High School Channel Trib 2	HSCT2_1	7.00	53
South High School Channel 1	SHSC_1	12.35	49
Tornillo Handle Channel 1	THC1_1	7.80	49
Tornillo Handle Channel 2	THC2_1	6.55	51
Tornillo Handle Channel 2	THC2_2	23.91	51

Table A-14. Summary of Lag Times for Vinton Study Area

Watershed Name	L _L		L _{CA}		S _{ST}	C _T	N	T _{lag}	T _{lag}	C _P
	(ft)	(mile)	(ft)	(mile)	(ft/ft)	(-)	(-)	(hr)	(min)	(-)
Flow Path Number 43	19,909	3.77	9,683	1.83	0.031	0.490	0.3	0.88	52.5	0.6125
Flow Path Number 44	5,983	1.13	3,012	0.57	0.018	0.275	0.3	0.24	14.5	0.6125
Flow Path Number 44	4,692	0.89	2,311	0.44	0.024	0.530	0.3	0.40	24.0	0.6125
Flow Path Number 44	30,564	5.79	14,858	2.81	0.035	0.470	0.3	1.09	65.1	0.6125

Table A-15. Summary of Lag Times for Canutillo Study Area

Watershed Name	L _L		L _{CA}		S _{ST}	C _T	N	T _{lag}	T _{lag}	C _P
	(ft)	(mile)	(ft)	(mile)	(ft/ft)	(-)	(-)	(hr)	(min)	(-)
First Avenue Channel	6,914	1.31	3,575	0.68	0.021	0.265	0.3	0.26	15.3	0.6125
Flow Path Number 42	6,792	1.29	3,609	0.68	0.025	0.260	0.3	0.25	15.0	0.6125
Flow Path Number 42	4,533	0.86	2,257	0.43	0.027	0.510	0.3	0.38	22.7	0.6125
Flow Path Number 42	25,349	4.80	12,775	2.42	0.029	0.500	0.3	1.04	62.6	0.6125
Flow Path Number 42A	1,210	0.23	560	0.11	0.044	0.440	0.3	0.14	8.7	0.6125
Flow Path Number 42B	4,046	0.77	2,020	0.38	0.028	0.500	0.3	0.35	20.8	0.6125
Flow Path Number 42C	11,359	2.15	5,880	1.11	0.024	0.530	0.3	0.69	41.3	0.6125
Flow Path Number 42D	4,889	0.93	2,572	0.49	0.025	0.520	0.3	0.41	24.6	0.6125

Table A-16. Summary of Lag Times for Socorro Study Area

Watershed Name	L _L		L _{CA}		S _{ST}	C _T	N	T _{lag}	T _{lag}	C _P
	(ft)	(mile)	(ft)	(mile)	(ft/ft)	(-)	(-)	(hr)	(min)	(-)
A_Mesa Spur 4-1	8,122	1.54	5,181	0.98	0.022	0.540	0.3	0.61	36.7	0.6125
A_Mesa Spur 4-2	4,829	0.91	2,150	0.41	0.029	0.250	0.3	0.19	11.2	0.6125
A_Mesa Spur 5.5-1	11,068	2.10	7,845	1.49	0.015	0.610	0.3	0.86	51.5	0.6719
A_Mesa Spur 5.5-2	4,287	0.81	2,257	0.43	0.039	0.460	0.3	0.33	20.1	0.6125
A_Mesa Spur 5-1	4,136	0.78	2,119	0.40	0.027	0.510	0.3	0.36	21.6	0.6125
A_Stream 4-1	4,688	0.89	2,268	0.43	0.030	0.490	0.3	0.37	22.0	0.6125
A_Stream 4-2	7,265	1.38	2,481	0.47	0.027	0.255	0.3	0.22	13.4	0.6125
A_Stream 4-2b	1,502	0.28	561	0.11	0.043	0.450	0.3	0.16	9.4	0.6125
A_Stream 4-3A	20,326	3.85	8,792	1.67	0.010	0.690	0.3	1.20	72.3	0.6719
A_Stream 4-3B	10,047	1.90	5,942	1.13	0.022	0.540	0.3	0.68	40.7	0.6125
A_Stream 5.5-1	4,662	0.88	2,348	0.44	0.025	0.520	0.3	0.39	23.6	0.6125
A_Stream 5.5-2	12,477	2.36	5,543	1.05	0.022	0.540	0.3	0.71	42.6	0.6125
A_Stream 5-1	4,663	0.88	2,489	0.47	0.031	0.495	0.3	0.38	22.8	0.6125
A_Stream 5-2	12,173	2.31	5,439	1.03	0.022	0.540	0.3	0.70	42.0	0.6125
A_Stream 5-2a	4,470	0.85	1,842	0.35	0.030	0.490	0.3	0.34	20.4	0.6125

Table A-17. Summary of Lag Times for Hacienda Real Study Area

Watershed Name	L _L		L _{CA}		S _{ST}	C _T	N	T _{lag}	T _{lag}	C _P
	(ft)	(mile)	(ft)	(mile)	(ft/ft)	(-)	(-)	(hr)	(min)	(-)
A_Clint Landfill A	2,939	0.56	1,471	0.28	0.024	0.525	0.3	0.30	18.0	0.6125
A_Clint Landfill B	5,873	1.11	3,177	0.60	0.021	0.550	0.3	0.49	29.3	0.6125
A_Clint Landfill C	4,950	0.94	2,495	0.47	0.020	0.560	1.3	0.19	11.7	0.6125
A_Clint Landfill D	4,463	0.85	1,962	0.37	0.021	0.550	2.3	0.01	2.3	0.6125
A_Hacienda Real-1	16,806	3.18	8,326	1.58	0.020	0.560	0.3	0.91	54.5	0.6125
A_Hacienda Real-2	4,765	0.90	2,470	0.47	0.001	1.700	0.3	1.31	78.8	0.6719
A_Hacienda Real-3	14,210	2.69	9,675	1.83	0.008	0.750	0.3	1.21	72.6	0.6719
A_Hacienda Real-4	11,775	2.23	5,365	1.02	0.020	0.560	0.3	0.72	42.9	0.6125
A_Hacienda Real-5	8,969	1.70	5,074	0.96	0.010	0.700	0.3	0.81	48.7	0.6719
A_Hacienda Real-6	11,804	2.24	5,497	1.04	0.019	0.565	0.3	0.73	43.7	0.6125
A_Hacienda Real-7	5,959	1.13	2,549	0.48	0.013	0.640	0.3	0.53	32.0	0.6719
A_Hacienda Real-8	18,689	3.54	11,393	2.16	0.013	0.640	0.3	1.18	70.7	0.6719
A_Stream 10-1	4,247	0.80	2,455	0.46	0.031	0.490	0.3	0.36	21.9	0.6125
A_Stream 10-2	1,887	0.36	783	0.15	0.036	0.470	0.3	0.19	11.7	0.6125
A_Stream 11-1	7,555	1.43	3,987	0.76	0.030	0.495	0.3	0.51	30.4	0.6125
A_Stream 11-2	4,900	0.93	2,520	0.48	0.023	0.530	0.3	0.42	24.9	0.6125
A_Stream 12-1	6,032	1.14	9,564	1.81	0.022	0.540	0.3	0.67	40.3	0.6125
A_Stream 12-2	18,863	3.57	3,066	0.58	0.018	0.570	0.3	0.71	42.6	0.6125
A_Stream 12-3	1,819	0.34	1,022	0.19	0.029	0.500	0.3	0.22	13.3	0.6125
A_Stream 12-4	7,375	1.40	3,857	0.73	0.028	0.505	0.3	0.51	30.5	0.6125
A_Stream 13.5-1-a	7,338	1.39	3,021	0.57	0.021	0.550	0.3	0.51	30.8	0.6125
A_Stream 13.5-1b	8,680	1.64	4,402	0.83	0.024	0.525	0.3	0.58	34.6	0.6125
A_Stream 13.5-2	2,253	0.43	982	0.19	0.019	0.565	0.3	0.26	15.9	0.6125
A_Stream 13.5-3	6,120	1.16	2,735	0.52	0.026	0.510	0.3	0.44	26.3	0.6125
A_Stream 13.5-4a	37,156	7.04	22,279	4.22	0.003	1.050	0.3	2.90	174.2	0.6719
A_Stream 13.5-4b	6,248	1.18	2,816	0.53	0.020	0.560	0.3	0.49	29.3	0.6125
A_Stream 13-1	2,070	0.39	1,145	0.22	0.023	0.530	0.3	0.25	15.2	0.6125
A_Stream 13-2	6,198	1.17	3,797	0.72	0.031	0.490	0.3	0.47	27.9	0.6125
A_Stream 6-1	7,022	1.33	3,330	0.63	0.028	0.505	0.3	0.48	28.7	0.6125

Table A-17. Summary of Lag Times for Hacienda Real Study Area (Continued)

Watershed Name	L _L		L _{CA}		S _{ST}	C _T	N	T _{lag}	T _{lag}	C _P
	(ft)	(mile)	(ft)	(mile)	(ft/ft)	(-)	(-)	(hr)	(min)	(-)
A_Stream 6-2	8,007	1.52	3,801	0.72	0.025	0.520	0.3	0.53	32.0	0.6125
A_Stream 7-1	6,733	1.28	2,969	0.56	0.025	0.520	0.3	0.47	28.2	0.6125
A_Stream 7-2	3,070	0.58	1,364	0.26	0.022	0.540	0.3	0.31	18.3	0.6125
A_Stream 7-3	7,567	1.43	2,537	0.48	0.024	0.525	0.3	0.47	28.2	0.6125
A_Stream 7-4	26,014	4.93	10,648	2.02	0.006	0.820	0.3	1.63	98.0	0.6719
A_Stream 8-1	2,262	0.43	779	0.15	0.018	0.570	0.3	0.25	14.9	0.6125
A_Stream 8-2	5,961	1.13	2,757	0.52	0.029	0.500	0.3	0.43	25.6	0.6125
A_Stream 8-3	13,250	2.51	6,915	1.31	0.017	0.585	0.3	0.84	50.2	0.6125
A_Stream 9-1	6,181	1.17	2,853	0.54	0.026	0.510	0.3	0.44	26.7	0.6125
A_Stream 9-2	3,768	0.71	1,871	0.35	0.031	0.490	0.3	0.32	19.5	0.6125

Table A-18. Summary of Lag Times for Fabens Study Area

Watershed Name	L _L		L _{CA}		S _{ST}	C _T	N	T _{Ia_q}	T _{Ia_q}	C _P
	(ft)	(mile)	(ft)	(mile)	(ft/ft)	(-)	(-)	(hr)	(min)	(-)
Fabens North 1	3,436	0.65	1,888	0.36	0.023	0.530	0.3	0.34	20.5	0.6125
Fabens North 1	5,362	1.02	2,646	0.50	0.026	0.510	0.3	0.42	25.0	0.6125
Fabens North 1	8,032	1.52	3,255	0.62	0.020	0.560	0.3	0.55	33.0	0.6125
Fabens North 2	6,105	1.16	2,340	0.44	0.019	0.570	0.3	0.47	28.0	0.6125
Fabens North 2	7,371	1.40	3,857	0.73	0.021	0.550	0.3	0.55	33.2	0.6125
Fabens North 2 Trib 1	9,830	1.86	4,952	0.94	0.019	0.570	0.3	0.67	40.4	0.6125
San Felipe Arroyo	16,231	3.07	7,937	1.50	0.010	0.700	0.3	1.11	66.5	0.6719
San Felipe Arroyo	33,343	6.31	17,389	3.29	0.011	0.670	0.3	1.67	99.9	0.6719
San Felipe Arroyo	17,144	3.25	8,388	1.59	0.009	0.720	0.3	1.18	70.7	0.6719
San Felipe Arroyo	15,508	2.94	7,966	1.51	0.010	0.700	0.3	1.09	65.6	0.6719
San Felipe Arroyo	11,715	2.22	4,766	0.90	0.011	0.670	0.3	0.83	49.5	0.6719
San Felipe Arroyo	12,548	2.38	5,985	1.13	0.012	0.660	0.3	0.89	53.3	0.6719
San Felipe Arroyo Trib 1	21,025	3.98	8,531	1.62	0.012	0.660	0.3	1.15	69.2	0.6719
San Felipe Arroyo Trib 1	47,034	8.91	26,287	4.98	0.006	0.820	0.3	2.56	153.5	0.6719

Table A-19. Summary of Lag Times for Tornillo Study Area

Watershed Name	L _L		L _{CA}		S _{ST}	C _T	N	T _{lag}	T _{lag}	C _P
	(ft)	(mile)	(ft)	(mile)	(ft/ft)	(-)	(-)	(hr)	(min)	(-)
Flow Path T	11,222	2.13	6,067	1.15	0.016	0.600	0.3	0.78	47.1	0.6125
Flow Path T	6,874	1.30	3,173	0.60	0.017	0.590	0.3	0.55	32.9	0.6125
High School Channel	4,399	0.83	2,131	0.40	0.015	0.610	0.3	0.44	26.4	0.6719
High School Channel	10,172	1.93	5,309	1.01	0.016	0.600	0.3	0.73	43.9	0.6125
High School Channel	9,319	1.77	4,998	0.95	0.018	0.580	0.3	0.68	40.6	0.6125
High School Channel Trib 1	3,376	0.64	1,631	0.31	0.015	0.610	0.3	0.37	22.5	0.6719
High School Channel Trib 1	7,719	1.46	3,911	0.74	0.014	0.620	0.3	0.63	38.1	0.6719
High School Channel Trib 2	5,302	1.00	2,581	0.49	0.022	0.540	0.3	0.44	26.2	0.6125
South High School Channel	7,165	1.36	3,578	0.68	0.020	0.560	0.3	0.55	32.8	0.6125
Tornillo Handle Channel 1	5,913	1.12	3,020	0.57	0.018	0.580	0.3	0.51	30.4	0.6125
Tornillo Handle Channel 2	6,346	1.20	3,625	0.69	0.017	0.590	0.3	0.56	33.4	0.6125
Tornillo Handle Channel 2	10,393	1.97	5,058	0.96	0.017	0.590	0.3	0.71	42.8	0.6125

Table A-20. Muskingum-Cunge Routing Inputs for Vinton Study Area

Reach Name	From Element	To Element	Length (ft)	Slope (ft/ft)	Channel Manning's n	Shape	Trapezoid		Eight Point	
							Bottom Width (ft)	Side Slope (xH:1V)	X	Y
R_FPN44_1	J_FPN44_FPN43	S_FPN44	707	0.013	0.030	Eight Pt.	N/A	N/A	0	3,807
									14	3,803
									19	3,801
									28	3,801
									34	3,801
									38	3,803
									56	3,805
									65	3,806
R_FPN44_2	A_FPN44_3	J_FPN44_2	4,316	0.025	0.043	Eight Pt.	N/A	N/A	0	3,912
									7	3,912
									227	3,909
									228	3,907
									295	3,907
									297	3,909
									363	3,912
									383	3,913

This page was intentionally left blank.

Table A-21. Muskingum-Cunge Routing Inputs for Canutillo Study Area

Reach Name	From Element	To Element	Length (ft)	Slope (ft/ft)	Channel Manning's n	Shape	Trapezoid		Eight Point	
							Bottom Width (ft)	Side Slope (xH:1V)	X	Y
R_FPN42_1	J_FPN42_2	S_FPN42_1	3,191	0.011	0.030	Eight Pt.	N/A	N/A	0 23 32 48 52 81 89 102	3,810 3,804 3,795 3,795 3,801 3,804 3,807 3,808
R_FPN42_2	J_FPN42A,3	J_FPN42_2	3,200	0.021	0.030	Eight Pt.	N/A	N/A	0 168 198 207 241 259 273 338	3,846 3,843 3,840 3,834 3,831 3,840 3,843 3,844
R_FPN42A_1	J_FPN42B,C,D	J_FPN42A	1,046	0.023	0.030	Eight Pt.	N/A	N/A	0 51 71 81 98 102 108 130	3,900 3,897 3,885 3,883 3,883 3,885 3,894 3,898

Table A-21. Muskingum-Cunge Routing Inputs for Canutillo Study Area (Continued)

Reach Name	From Element	To Element	Length (ft)	Slope (ft/ft)	Channel Manning's n	Shape	Trapezoid		Eight Point	
							Bottom Width (ft)	Side Slope (xH:1V)	X	Y
R_FPN42C_1	A_FPN42D_1	J_FPN42D_C	1,096	0.016	0.030	Eight Pt.	N/A	N/A	0	3,914
									32	3,912
									43	3,906
									49	3,904
									61	3,904
									64	3,906
									78	3,915
									104	3,916

Table A-22. Muskingum-Cunge Routing Inputs for Socorro Study Area

Reach Name	From Element	To Element	Length (ft)	Slope (ft/ft)	Channel Manning's n	Shape	Trapezoid		Eight Point	
							Bottom Width (ft)	Side Slope (xH:1V)	X	Y
R_Mesa Drain 5.5	R_Mesa Spur 5.5 DS	J_AMS551_RMD55_OUT	1,569.74	0.00154	0.05	Trapezoid	15	2	N/A	N/A
R_Mesa Spur 4	R_Mesa Spur 4-2	J_AMS41_RS4_RMS4_OUT	3,709.76	5.5E-05	0.05	Trapezoid	10	1	N/A	N/A
R_Mesa Spur 4-2	A_Mesa Spur 4-2	R_Mesa Spur 4	3,754.97	0.03572	0.03	Rectangle	40	N/A	N/A	N/A
R_Mesa Spur 5	R_Stream 5-1	J_AMS51_RMS5_OUT	425.32	5.5E-05	0.05	Trapezoid	10	1	N/A	N/A
R_Mesa Spur 5.5-2	A_Mesa Spur 5.5-2	R_Mesa Spur 5.5 US	5,367.07	0.03132	0.03	Rectangle	40	N/A	N/A	N/A
R_Mesa Spur 5.5 DS	J_RMS55US_RS551	R_Mesa Drain 5.5	979.85	5.5E-05	0.05	Trapezoid	10	1	N/A	N/A
R_Mesa Spur 5.5 US	R_Mesa Spur 5.5-2	J_RMS55US_RS551	1,673.22	5.5E-05	0.05	Trapezoid	10	1	N/A	N/A
R_Stream 4-1	J_AS41_RS42	J_AMS41_RS4_RMS4_OUT	1,061.72	0.01484	0.03	Rectangle	40	N/A	N/A	N/A
R_Stream 4-2	J_AS42_RS43	J_AS41_RS42	4,021.33	0.0279	0.03	Rectangle	90	N/A	N/A	N/A
R_Stream 4-2b	A_Stream 4-2b	J_AS41_RS42_RS42b	4,030.07	0.03226	0.03	Rectangle	10	N/A	N/A	N/A
R_Stream 4-3	J_AS43A_AS43B	J_AS42_RS43	2,805.93	0.0218	0.03	Rectangle	80	N/A	N/A	N/A
R_Stream 5.5-1	J_AS551_R552	J_RMS55US_RS551	1,891.93	0.01455	0.03	Rectangle	40	N/A	N/A	N/A
R_Stream 5.5-2	A_Stream 5.5-2	J_AS551_R552	4,074.03	0.02947	0.03	Rectangle	50	N/A	N/A	N/A
R_Stream 5-1	J_AS551_R552	R_Mesa Spur 5	811.76	0.05397	0.03	Rectangle	50	N/A	N/A	N/A
R_Stream 5-2	A_Stream 5-2	J_AS551_R552	4,096.66	0.02682	0.03	Rectangle	60	N/A	N/A	N/A
R_Stream 5-2a	A_Stream 5-2a	J_AS551_R552_RS52a	4,049.39	0.02698	0.03	Rectangle	10	N/A	N/A	N/A

This page was intentionally left blank.

Table A-23. Muskingum-Cunge Routing Inputs for Hacienda Real Study Area

Reach Name	From Element	To Element	Length (ft)	Slope (ft/ft)	Channel Manning's n	Shape	Trapezoid		Eight Point	
							Bottom Width (ft)	Side Slope (xH:1V)	X	Y
R_Clint Landfill A	A_Clint Landfill A	J_AS8-3	4,454	0.028	0.030	Rectangle	50	N/A	N/A	N/A
R_Clint Landfill B	A_Clint Landfill B	J_AS9-2	2,758	0.029	0.030	Rectangle	60	N/A	N/A	N/A
R_Clint Landfill C	A_Clint Landfill C	J_AS10-2	1,287	0.043	0.030	Rectangle	200	N/A	N/A	N/A
R_Clint Landfill D	A_Clint Landfill D	J_A11-2	3,411	0.030	0.030	Rectangle	100	N/A	N/A	N/A
R_Stream 10-2	J_AS10-2	J_AS10-2&AS9-1	4,244	0.030	0.030	Rectangle	25	N/A	N/A	N/A
R_Stream 11-1	J_AS11-1	J_AHR6	5,066	0.004	0.035	Rectangle	200	N/A	N/A	N/A
R_Stream 11-2	A_Stream 11-2	J_AS11-1	4,990	0.029	0.030	Rectangle	30	N/A	N/A	N/A
R_Stream 12-1	J_AS12-1	J_AHR7	1,018	0.001	0.040	Rectangle	200	N/A	N/A	N/A
R_Stream 12-2	J_AS12-2	J_AS12-1	3,288	0.020	0.030	Rectangle	60	N/A	N/A	N/A
R_Stream 12-3 and Stream 13-1	J_AS12-3&AS13-1	J_AS12-2	1,966	0.021	0.030	Rectangle	60	N/A	N/A	N/A
R_Stream 12-4	A_Stream 12-4	J_AS12-3&AS13-1	1,670	0.031	0.030	Rectangle	40	N/A	N/A	N/A
R_Stream 13.5-1a	A_Stream 8-3	J_AS8-3	5,406	0.003	0.040	Rectangle	200	N/A	N/A	N/A
R_Stream 13.5-1b	J_AS13.5-1b	J_AHR8	4,823	0.007	0.040	Rectangle	200	N/A	N/A	N/A
R_Stream 13.5-2a	D_AS13.5-2	J_AS13.5-1a	5,709	0.021	0.030	Rectangle	40	N/A	N/A	N/A
R_Stream 13.5-2b	D_AS13.5-3	J_AS13.5-1b	3,712	0.026	0.030	Rectangle	60	N/A	N/A	N/A
R_Stream 13.5-3	J_AS13.5-3	D_AS13.5-2	1,684	0.029	0.030	Rectangle	50	N/A	N/A	N/A
R_Stream 13.5-4	J_AS13.5-4a&AS13.5-4b	J_AS13.5-3	3,724	0.015	0.030	Rectangle	45	N/A	N/A	N/A
R_Stream 13-2	A_Stream 13-2	J_AS12-2&AS13-1	1,788	0.033	0.030	Rectangle	35	N/A	N/A	N/A
R_Stream 6-1	J_AS6-1	J_AHR2	4,564	0.006	0.04	Rectangle	200	N/A	N/A	N/A
R_Stream 6-2	J_AS6-2	J_AS6-1	4,711	0.026	0.03	Rectangle	200	N/A	N/A	N/A
R_Stream 7-1	J_AS7-1	J_AHR3	4,501	0.002	0.035	Rectangle	200	N/A	N/A	N/A
R_Stream 7-2	J_AS7-2	J_AS7-1	3,754	0.026	0.03	Rectangle	75	N/A	N/A	N/A
R_Stream 7-3	J_AS7-3	J_AS7-2	2,381	0.021	0.03	Rectangle	90	N/A	N/A	N/A
R_Stream 7-4	A_Stream 7-4	J_AS7-3	4,157	0.012	0.03	Rectangle	90	N/A	N/A	N/A
R_Stream 8-1	J_AS8-1	J_AHR4	3,359	0.004	0.04	Rectangle	200	N/A	N/A	N/A

Table A-23. Muskingum-Cunge Routing Inputs for Hacienda Real Study Area (Continued)

Reach Name	From Element	To Element	Length (ft)	Slope (ft/ft)	Channel Manning's n	Shape	Trapezoid		Eight Point	
							Bottom Width (ft)	Side Slope (xH:1V)	X	Y
R_Stream 8-2	J_AS8-2	J_AS8-1	1,886	0.033	0.03	Rectangle	25	N/A	N/A	N/A
R_Stream 8-3	J_AS8-3	J_AS8-2	3,252	0.025	0.03	Rectangle	50	N/A	N/A	N/A
R_Stream 9-1 and Stream 10-1	J_AS10-2&AS9-1	J_AHR5	6,183	0.005	0.04	Rectangle	200	N/A	N/A	N/A
R_Stream 9-2	J_AS9-2	J_AS10-2&AS9-1	4,666	0.026	0.03	Rectangle	45	N/A	N/A	N/A

Table A-24. Muskingum-Cunge Routing Inputs for Fabens Study Area

Reach Name	From Element	To Element	Length (ft)	Slope (ft/ft)	Channel Manning's n	Shape	Trapezoid		Eight Point	
							Bottom Width (ft)	Side Slope (xH:1V)	X	Y
R_FN1_1	J_FN1_2,3	S_FN1_1	2,181	0.022	0.040	Eight Pt.	N/A	N/A	0	3,669
									97	3,666
									482	3,660
									493	3,657
									518	3,657
									528	3,660
									568	3,663
									657	3,671
R_FN1_2	A_FN1_3	J_FN1_2	4,481	0.024	0.043	Eight Pt.	N/A	N/A	0	3,744
									150	3,738
									413	3,729
									456	3,728
									515	3,728
									560	3,729
									772	3,732
									933	3,741
R_FN2_1	J_FN2T1_1, FN2_2	J_FN2_1	4,832	0.019	0.040	Eight Pt.	N/A	N/A	0	3,738
									252	3,732
									254	3,731
									326	3,731
									328	3,732
									497	3,735
									567	3,738
									597	3,739

Table A-24. Muskingum-Cunge Routing Inputs for Fabens Study Area (Continued)

Reach Name	From Element	To Element	Length (ft)	Slope (ft/ft)	Channel Manning's n	Shape	Trapezoid		Eight Point	
							Bottom Width (ft)	Side Slope (xH:1V)	X	Y
R_SFA_1	S_SFA_FL1	S_SFA_1	13,536	0.007	0.043	Eight Pt.	N/A	N/A	0 15 17 23 29 59 66 89	3,630 3,633 3,633 3,630 3,627 3,627 3,630 3,630
R_SFA_FL1	J_SFA_FL_2,SFAT1	S_SFA_FL1	16,463	0.005	0.040	Eight Pt.	N/A	N/A	0 181 533 574 610 654 786 973	3,783 3,771 3,765 3,763 3,763 3,765 3,768 3,775
R_SFA_FL2	S_SFA_RSL	J_SFA_FL2	4,203	0.006	0.045	Eight Pt.	N/A	N/A	0 107 277 342 385 402 487 755	3,819 3,813 3,810 3,808 3,808 3,810 3,813 3,820

Table A-24. Muskingum-Cunge Routing Inputs for Fabens Study Area (Continued)

Reach Name	From Element	To Element	Length (ft)	Slope (ft/ft)	Channel Manning's n	Shape	Trapezoid		Eight Point	
							Bottom Width (ft)	Side Slope (xH:1V)	X	Y
R_SFA_RSL	S_SFA_PDB	S_SFA_RSL	7,351	0.005	0.045	Eight Pt.	N/A	N/A	0 188 377 412 488 503 725 985	3,864 3,852 3,849 3,848 3,848 3,849 3,852 3,858
R_SFA_PDB	S_SFA_RT	S_SFA_PDB	7,683	0.009	0.040	Eight Pt.	N/A	N/A	0 141 395 416 451 458 592 841	3,915 3,909 3,903 3,902 3,902 3,903 3,906 3,918
R_SFAT1_1	S_SFAT1_D6	J_SFA_FL2, SFAT1	2,318	0.008	0.030	Eight Pt.	N/A	N/A	0 95 152 201 222 239 266 288	3,825 3,822 3,819 3,816 3,807 3,807 3,813 3,816

This page was intentionally left blank.

Table A-25. Muskingum-Cunge Routing Inputs for Tornillo Study Area

Reach Name	From Element	To Element	Length (ft)	Slope (ft/ft)	Channel Manning's n	Shape	Trapezoid		Eight Point	
							Bottom Width (ft)	Side Slope (xH:1V)	X	Y
R_FPT_1	A_FPT_2	S_FPT_1	11,222	0.017	0.040	Eight Pt.	N/A	N/A	0	3,768
									130	3,765
									231	3,762
									266	3,761
									324	3,761
									344	3,762
									434	3,765
									584	3,768
R_HSC_1	J_HSC_2,SHSC_1	S_HSC_1	710	0.021	0.035	Eight Pt.	N/A	N/A	0	3,649
									166	3,648
									368	3,645
									391	3,644
									410	3,644
									431	3,645
									645	3,646
									820	3,648
R_HSC_2	J_HSC_3,HSCT1	J_HSC_2	7,746	0.015	0.040	Eight Pt.	N/A	N/A	0	3,729
									190	3,723
									368	3,720
									387	3,719
									460	3,719
									474	3,720
									602	3,723
									684	3,726

Table A-25. Muskingum-Cunge Routing Inputs for Tornillo Study Area (Continued)

Reach Name	From Element	To Element	Length (ft)	Slope (ft/ft)	Channel Manning's n	Shape	Trapezoid		Eight Point	
							Bottom Width (ft)	Side Slope (xH:1V)	X	Y
R_HSCT1_1	J_HSCT1,2	J_HSCT1_1	2,558	0.015	0.040	Eight Pt.	N/A	N/A	0	3,792
									162	3,786
									308	3,783
									319	3,782
									335	3,782
									339	3,783
									458	3,789
									558	3,792
R_THC2_1	J_THC2,THC1	S_THC2_1	3,194	0.012	0.045	Eight Pt.	N/A	N/A	0	3,604
									57	3,603
									82	3,602
									83	3,601
									111	3,601
									112	3,602
									135	3,603
									190	3,604

Table A-26. Adjusted Areas for Socorro Study Area

Watershed Name	Unadjusted Watershed Area (mi²)	Unmodeled Storage Area (mi²)	Adjusted Watershed Area (mi²)
A_Mesa Spur 4-1	0.45	0.033	0.42
A_Mesa Spur 4-2	0.11	0.006	0.11
A_Mesa Spur 5.5-1	0.91	0.036	0.87
A_Mesa Spur 5.5-2	0.32	0.000	0.32
A_Mesa Spur 5-1	0.08	0.008	0.07
A_Stream 4-1	0.21	0.000	0.21
A_Stream 4-2	0.44	0.001	0.44
A_Stream 4-2b	0.03	0.000	0.03
A_Stream 4-3A	1.93	0.000	1.93
A_Stream 4-3B	0.65	0.000	0.65
A_Stream 5.5-1	0.09	0.001	0.09
A_Stream 5.5-2	1.34	0.000	1.34
A_Stream 5-1	0.18	0.001	0.18
A_Stream 5-2	0.78	0.000	0.78
A_Stream 5-2a	0.11	0.000	0.11

Table A-27. Adjusted Curve Numbers for Socorro Study Area

Watershed Name	Initial CN	Storage Adjusted CN
A_Stream 4-2	60	48
A_Stream 4-3A	76	63

Table A-28. Adjusted Areas for Hacienda Real Study Area

Watershed Name	Unadjusted Watershed Area (mi²)	Unmodeled Storage Area (mi²)	Adjusted Watershed Area (mi²)
A_Clint Landfill A	0.11	0.000	0.11
A_Clint Landfill B	0.32	0.000	0.32
A_Clint Landfill C	0.27	0.000	0.27
A_Clint Landfill D	0.28	0.000	0.28
A_Hacienda Real-1	1.82	0.002	1.82
A_Hacienda Real-2	0.18	0.000	0.18
A_Hacienda Real-3	0.51	0.001	0.51
A_Hacienda Real-4	0.63	0.001	0.63
A_Hacienda Real-5	0.42	0.000	0.42
A_Hacienda Real-6	0.64	0.000	0.64
A_Hacienda Real-7	0.27	0.004	0.27
A_Hacienda Real-8	1.99	0.003	1.99
A_Stream 10-1	0.08	0.000	0.08
A_Stream 10-2	0.06	0.000	0.06
A_Stream 11-1	0.41	0.000	0.41
A_Stream 11-2	0.11	0.000	0.11
A_Stream 12-1	0.16	0.000	0.16
A_Stream 12-2	0.87	0.000	0.87
A_Stream 12-3	0.03	0.000	0.03
A_Stream 12-4	0.38	0.000	0.38
A_Stream 13.5-1a	0.24	0.000	0.24
A_Stream 13.5-1b	0.46	0.000	0.46
A_Stream 13.5-2	0.04	0.000	0.04
A_Stream 13.5-3	0.53	0.000	0.53
A_Stream 13.5-4a	5.67	0.027	5.64
A_Stream 13.5-4b	0.49	0.000	0.49
A_Stream 13-1	0.02	0.000	0.02
A_Stream 13-2	0.38	0.000	0.38
A_Stream 6-1	0.34	0.009	0.33
A_Stream 6-2	0.51	0.000	0.51
A_Stream 7-1	0.25	0.000	0.25
A_Stream 7-2	0.08	0.000	0.08
A_Stream 7-3	0.47	0.000	0.47
A_Stream 7-4	4.91	0.033	4.88
A_Stream 8-1	0.04	0.000	0.04
A_Stream 8-2	0.29	0.000	0.29
A_Stream 8-3	0.64	0.000	0.64
A_Stream 9-1	0.24	0.000	0.24
A_Stream 9-2	0.14	0.000	0.14

Table A-29. Estimation of Rainfall Depth by Annual Exceedance Probability

Return Frequency	Total Rainfall Depth (inches) by Duration						
	1 hr	2 hr	3 hr	4 hr	6 hr	12 hr	24 hr
Central and Northeast El Paso							
1	0.41	0.52	0.57	0.61	0.66	0.72	0.8
2	0.7	0.88	0.95	0.99	1.07	1.18	1.35
5	0.97	1.22	1.3	1.36	1.46	1.61	1.83
10	1.15	1.45	1.55	1.62	1.73	1.91	2.16
25	1.41	1.79	1.89	1.99	2.11	2.33	2.6
50	1.61	20.6	2.18	2.3	2.43	2.68	2.96
100	1.84	2.36	2.49	2.64	2.78	3.06	3.34
250	2.18	2.82	2.96	3.16	3.3	3.63	3.89
500	2.47	3.21	3.37	3.62	3.74	4.12	4.35
West El Paso							
1	0.43	0.54	0.59	0.63	0.68	0.74	0.83
2	0.73	0.91	0.98	1.03	1.11	1.22	1.4
5	1.04	1.31	1.4	1.47	1.58	1.74	1.98
10	1.28	1.62	1.72	1.81	1.93	2.13	2.41
25	1.64	2.08	2.2	2.32	2.46	2.72	3.03
50	1.95	2.49	2.63	2.77	2.93	3.23	3.57
100	2.31	2.96	3.12	3.31	3.47	3.83	4.18
250	2.86	3.7	3.89	4.15	4.33	4.76	5.11
500	3.36	4.36	4.58	4.92	5.09	5.6	5.92
East El Paso							
1	0.35	0.45	0.49	0.52	0.56	0.61	0.69
2	0.64	0.8	0.87	0.91	0.98	1.08	1.23
5	0.97	1.22	1.3	1.36	1.46	1.61	1.83
10	1.22	1.54	1.64	1.72	1.84	2.02	2.29
25	1.61	2.05	2.17	2.28	2.42	2.67	2.98
50	1.96	2.5	2.64	2.79	2.95	3.25	3.59
100	2.38	3.05	3.21	3.41	3.58	3.94	4.3
250	3.04	3.92	4.12	4.4	4.59	5.05	5.42
500	3.65	4.73	4.97	5.34	5.52	6.08	6.42

Source: City of El Paso, 2008. El Paso Drainage Design Manual (DDM).

Table A-30. Complete HEC-HMS Results for 100-Year Storm - Vinton Study Area

Schematic Figure No.(s)	Element Name	Area (mi ²)	100-Year Peak Discharge (cfs)	100-Year Volume (acre-feet)
A-34	A_FPN43_1	1.26	896.8	169.9
A-34	A_FPN44_1	0.13	118.5	9.8
A-34	A_FPN44_2	0.07	82.3	9.1
A-34	A_FPN44_3	2.13	1,310.3	287.1
A-34	J_FPN44_2	2.20	1,300.3	296.3
A-34	J_FPN44_FPN43	3.46	2,153.1	466.2
A-34	R_FPN44_1	3.46	2,145.8	466.2
A-34	R_FPN44_2	2.13	1,279.9	287.2
A-34	S_FPN44	3.58	2,169.2	476.0

Table A-31. Complete HEC-HMS Results for 100-Year Storm - Canutillo Study Area

Schematic Figure No.(s)	Element Name	Area (mi ²)	100-Year Peak Discharge (cfs)	100-Year Volume (acre-feet)
A-35	A_FAC_1	0.41	533.0	44.3
A-35	A_FPN42_1	0.17	140.9	11.8
A-35	A_FPN42_2	0.14	140.5	15.2
A-35	A_FPN42_3	1.94	1,244.8	261.5
A-35	A_FPN42A_1	0.01	24.0	2.0
A-35	A_FPN42B_1	0.10	140.0	14.2
A-35	A_FPN42C_1	0.26	229.0	36.8
A-35	A_FPN42D_1	0.07	92.9	10.4
A-35	J_FPN42_2	2.53	1,577.9	340.4
A-35	J_FPN42A	0.45	424.4	63.5
A-35	J_FPN42A,3	2.39	1,526.6	325.0
A-35	J_FPN42B,C,D	0.44	420.0	61.5
A-35	J_FPN42D_C	0.34	312.9	47.3
A-35	R_FPN42_1	2.53	1,572.5	340.6
A-35	R_FPN42_2	2.39	1,523.0	325.2
A-35	R_FPN42A_1	0.44	417.8	61.5
A-35	R_FPN42C_1	0.07	87.7	10.5
A-35	S_FAC_1	0.41	533.0	44.3
A-35	S_FPN42_1	2.70	1,602.4	352.5

Table A-32. Complete HEC-HMS Results for 100-Year Storm - Socorro Study Area

Schematic Figure No.(s)	Element Name	Area (mi ²)	100-Year Peak Discharge (cfs)	100-Year Volume (acre-feet)
A-36	A_Mesa Spur 4-1	0.42	149.1	24.5
A-36	A_Mesa Spur 4-2	0.11	71.1	5.7
A-36	A_Mesa Spur 5.5-1	0.87	265.4	50.0
A-36	A_Mesa Spur 5.5-2	0.32	115.4	14.0
A-36	A_Mesa Spur 5-1	0.07	51.3	5.6
A-36	A_Stream 4-1	0.21	123.9	14.0
A-36	A_Stream 4-2	0.44	51.9	8.0
A-36	A_Stream 4-2b	0.03	23.3	1.6
A-36	A_Stream 4-3A	1.93	466.9	110.4
A-36	A_Stream 4-3B	0.65	209.0	37.0
A-36	A_Stream 5.5-1	0.09	50.5	6.0
A-36	A_Stream 5.5-2	1.34	308.3	60.2
A-36	A_Stream 5-1	0.18	81.9	10.0
A-36	A_Stream 5-2	0.78	185.3	35.5
A-36	A_Stream 5-2a	0.11	53.7	6.2
A-36	J_AMS41_RS4_RMS4_OUT	3.77	832.6	199.2
A-36	J_AMS51_RMS5_OUT	1.15	304.5	55.8
A-36	J_AMS551_RMD55_OUT	2.63	655.7	124.8
A-36	J_AS41_RS42_RS42b	3.24	708.4	171.1
A-36	J_AS42_RS43	3.01	658.3	155.4
A-36	J_AS43A_AS43B	2.58	635.7	147.4
A-36	J_AS51_RS52_RS42a	1.07	277.9	51.6
A-36	J_AS551_R552	1.43	340.9	66.2
A-36	J_RMS55US_RS551	1.75	418.7	78.6
A-36	R_Mesa Drain 5.5	1.75	393.4	74.8
A-36	R_Mesa Spur 4	0.11	54.3	3.6
A-36	R_Mesa Spur 4-2	0.11	70.9	5.7
A-36	R_Mesa Spur 5	1.07	273.5	50.3
A-36	R_Mesa Spur 5.5-2	0.32	115.3	14.0
A-36	R_Mesa Spur 5.5 DS	1.75	407.1	75.3
A-36	R_Mesa Spur 5.5 US	0.32	106.0	12.4
A-36	R_Stream 4-1	3.24	708.4	171.1
A-36	R_Stream 4-2	3.01	658.2	155.4
A-36	R_Stream 4-2b	0.03	23.2	1.6
A-36	R_Stream 4-3	2.58	635.6	147.4
A-36	R_Stream 5.5-1	1.43	340.9	66.2
A-36	R_Stream 5.5-2	1.34	308.2	60.2
A-36	R_Stream 5-1	1.07	277.9	51.6
A-36	R_Stream 5-2	0.78	185.2	35.5
A-36	R_Stream 5-2a	0.11	53.7	6.2

This page was intentionally left blank.

Table A-33. Complete HEC-HMS Results for 100-Year Storm - Hacienda Real Study Area

Schematic Figure Number(s)	Element Name	Area (mi ²)	100-Year Peak Discharge (cfs)	100-Year Volume (acre-feet)
A-37	A_Clint Landfill A	0.11	147.1	13.2
A-37	A_Clint Landfill B	0.32	383.1	46.7
A-37	A_Clint Landfill C	0.27	422.3	29.0
A-37	A_Clint Landfill D	0.28	570.4	28.4
A-37	A_Hacienda Real 1	1.82	465.6	100.5
A-37	A_Hacienda Real 2	0.18	54.5	13.1
A-37	A_Hacienda Real-3	0.51	139.0	32.3
A-37	A_Hacienda Real-4	0.63	190.1	35.1
A-37	A_Hacienda Real-5	0.42	155.7	27.4
A-37	A_Hacienda Real-6	0.64	173.6	33.0
A-37	A_Hacienda Real-7	0.27	123.3	16.6
A-37	A_Hacienda Real-8	1.99	377.5	91.9
A-37	A_Stream 10-1	0.08	27.5	3.6
A-37	A_Stream 10-2	0.06	26.5	2.4
A-37	A_Stream 11-1	0.41	102.5	16.7
A-37	A_Stream 11-2	0.11	25.0	3.8
A-37	A_Stream 12-1	0.16	32.2	6.3
A-37	A_Stream 12-2	0.87	377.8	65.1
A-37	A_Stream 12-3	0.03	19.9	1.7
A-37	A_Stream 12-4	0.38	106.4	16.8
A-37	A_Stream 13.5-1a	0.24	56.1	9.3
A-37	A_Stream 13.5-1b	0.46	102.7	18.3
A-37	A_Stream 13.5-2	0.04	26.5	2.4
A-37	A_Stream 13.5-3	0.53	123.0	19.2
A-37	A_Stream 13.5-4a	5.64	1,569.9	685.5
A-37	A_Stream 13.5-4b	0.49	195.4	28.0
A-37	A_Stream 13-1	0.02	12.7	1.1
A-37	A_Stream 13-2	0.38	99.3	15.4
A-37	A_Stream 6-1	0.33	143.1	19.9
A-37	A_Stream 6-2	0.51	111.3	19.2
A-37	A_Stream 7-1	0.25	64.3	10.0
A-37	A_Stream 7-2	0.08	43.0	4.5
A-37	A_Stream 7-3	0.47	130.4	19.9
A-37	A_Stream 7-4	4.88	2,040.2	556.0
A-37	A_Stream 8-1	0.04	13.4	1.4
A-37	A_Stream 8-2	0.29	83.3	12.2
A-37	A_Stream 8-3	0.64	250.2	48.0
A-37	A_Stream 9-1	0.24	62.9	9.4
A-37	A_Stream 9-2	0.14	39.4	5.1
A-37	D_AS13.5-2	6.71	805.0	367.6
A-37	D_Clint Landfill Pond 1,2,DE	0.32	0.0	0.0

Table A-33. Complete HEC-HMS Results for 100-Year Storm - Hacienda Real Study Area (Continued)

Schematic Figure Number(s)	Element Name	Area (mi ²)	100-Year Peak Discharge (cfs)	100-Year Volume (acre-feet)
A-37	D_Clint Landfill Pond 3 & 4	0.27	24.8	6.5
A-37	D_Clint Landfill Pond 6 & 7	0.11	69.3	5.8
A-37	J_AHR2	1.02	278.4	52.2
A-37	J_AHR3	6.18	2,201.7	622.0
A-37	J_AHR4	1.72	490.5	102.6
A-37	J_AHR5	1.53	274.3	54.3
A-37	J_AHR6	1.44	688.4	81.7
A-37	J_AHR7	2.10	717.2	122.7
A-37	J_AHR8	9.41	1,764.5	854.4
A-37	J_AS10-2	0.33	26.5	8.9
A-37	J_AS10-2&AS9-1	1.11	148.2	27.0
A-37	J_AS11-1	0.80	619.5	49.0
A-37	J_AS11-2	0.39	575.9	32.2
A-37	J_AS12-1	1.83	630.1	106.4
A-37	J_AS12-2	1.67	598.1	100.1
A-37	J_AS12-3&AS13-1	0.80	223.7	35.0
A-37	J_AS13.5-1a	6.95	813.1	376.9
A-37	J_AS13.5-1b	0.46	823.1	385.9
A-37	J_AS13.5-3	6.67	1,608.6	732.7
A-37	J_AS13.5-4a&AS13.5-4b	6.14	1,592.2	713.5
A-37	J_AS6-1	0.84	226.9	39.1
A-37	J_AS7-1	5.67	2,110.0	590.3
A-37	J_AS7-2	5.42	2,089.6	580.4
A-37	J_AS7-3	5.35	2,084.0	575.9
A-37	J_AS8-1	1.09	367.7	67.5
A-37	J_AS8-2	1.05	363.9	66.1
A-37	J_AS8-3	0.76	309.0	53.9
A-37	J_AS9-2	0.46	39.4	5.1
A-37	R_Clint Landfill A	0.11	65.2	5.8
A-37	R_Clint Landfill B	0.32	0.0	0.0
A-37	R_Clint Landfill C	0.27	23.7	6.5
A-37	R_Clint Landfill D	0.28	567.5	28.4
A-37	R_Stream 10-2	0.33	26.4	8.9
A-37	R_Stream 11-1	0.80	530.1	48.7
A-37	R_Stream 11-2	0.39	571.6	32.3
A-37	R_Stream 12-1	1.83	618.4	106.1
A-37	R_Stream 12-2	1.67	597.9	100.1
A-37	R_Stream 12-3 & Stream 13-1	0.80	223.6	35.0
A-37	R_Stream 12-4	0.38	106.4	16.8
A-37	R_Stream 13.5-1a	6.95	811.6	376.7
A-37	R_Stream 13.5-1b	0.46	822.8	385.9
A-37	R_Stream 13.5-2a	6.71	805.0	367.6

Table A-33. Complete HEC-HMS Results for 100-Year Storm - Hacienda Real Study Area (Continued)

Schematic Figure Number(s)	Element Name	Area (mi ²)	100-Year Peak Discharge (cfs)	100-Year Volume (acre-feet)
A-37	R_Stream 13.5-2b	0.00	805.0	367.6
A-37	R_Stream 13.5-3	6.67	1,608.6	732.7
A-37	R_Stream 13.5-4	6.14	1,592.1	713.5
A-37	R_Stream 13-2	0.38	99.3	15.4
A-37	R_Stream 6-1	0.84	225.5	39.1
A-37	R_Stream 6-2	0.51	111.3	19.2
A-37	R_Stream 7-1	5.67	2,096.9	589.7
A-37	R_Stream 7-2	5.42	2,089.4	580.4
A-37	R_Stream 7-3	5.35	2,083.8	575.9
A-37	R_Stream 7-4	4.88	2,039.8	556.0
A-37	R_Stream 8-1	1.09	351.1	67.5
A-37	R_Stream 8-2	1.05	362.5	66.1
A-37	R_Stream 8-3	0.76	306.3	53.9
A-37	R_Stream 9-1 and 9-2	1.11	143.2	26.9
A-37	R_Stream 9-2	0.46	39.4	5.1
A-37	S_Clint Landfill Pond 1,2,DE	0.00	383.1	46.7
A-37	S_Clint Landfill Pond 3 & 4	0.00	422.3	22.5
A-37	S_Clint Landfill Pond 6 & 7	0.00	147.1	7.4

This page was intentionally left blank.

Table A-34. Complete HEC-HMS Results for 100-Year Storm - Fabens Study Area

Schematic Figure Number(s)	Element Name	Area (mi ²)	100-Year Peak Discharge (cfs)	100-Year Volume (acre-feet)
A-38	A_FN1_1	0.08	10.2	1.7
A-38	A_FN1_2	0.16	30.9	4.8
A-38	A_FN1_3	0.37	53.6	10.1
A-38	A_FN2_1	0.17	33.0	5.2
A-38	A_FN2_2	0.45	45.0	9.3
A-38	A_FN2T1_1	0.45	58.0	12.3
A-38	A_SFA_1	1.03	200.2	46.9
A-38	A_SFA_FL1	7.56	720.1	244.1
A-38	A_SFA_FL2	1.14	113.3	31.4
A-38	A_SFA_PDB	2.66	563.8	129.2
A-38	A_SFA_RSL	1.34	314.4	61.1
A-38	A_SFA_RT	1.40	442.6	85.5
A-38	A_SFAT1_1	1.86	465.7	107.7
A-38	A_SFAT1_D6	7.87	2,157.3	858.9
A-38	J_FN1_2	0.53	73.8	14.9
A-38	J_FN1_2,3	1.60	200.9	41.8
A-38	J_FN2_1	1.07	127.0	26.9
A-38	J_FN2T1_1,FN2_2	0.90	103.0	21.6
A-38	J_SFA_FL_2,SFAT1	16.26	958.0	1,076.6
A-38	J_SFA_FL2	6.54	145.9	134.1
A-38	R_FN1_1	1.60	194.7	41.9
A-38	R_FN1_2	0.37	51.9	10.1
A-38	R_FN2_1	0.90	101.8	21.7
A-38	R_SFA_1	23.82	628.5	1,029.4
A-38	R_SFA_FL1	16.26	955.1	1,040.2
A-38	R_SFA_FL2	5.39	59.4	102.7
A-38	R_SFA_PDB	1.40	100.2	79.0
A-38	R_SFA_RSL	4.06	134.2	68.3
A-38	R_SFAT1_1	7.87	836.4	834.8
A-38	S_FN1_1	1.68	202.1	43.6
A-38	S_SFA_1	24.85	637.8	1,076.4
A-38	S_SFA_FL1	23.82	628.6	1,054.9
A-38	S_SFA_PDB	4.06	163.1	69.2
A-38	S_SFA_RSL	5.39	59.4	105.3
A-38	S_SFA_RT	1.40	100.3	79.5
A-38	S_SFAT1_D6	7.87	837.9	836.7

Table A-35. Complete HEC-HMS Results for 100-Year Storm - Tornillo Study Area

Schematic Figure Number(s)	Element Name	Area (mi ²)	100-Year Peak Discharge (cfs)	100-Year Volume (acre-feet)
A-39	A_FPT_1	0.43	46.8	10.9
A-39	A_FPT_2	0.44	143.5	22.7
A-39	A_HSC_1	0.08	21.7	2.9
A-39	A_HSC_2	0.36	33.0	7.5
A-39	A_HSC_3	0.28	65.1	12.2
A-39	A_HSCT1_1	0.12	30.3	4.1
A-39	A_HSCT1_2	0.26	121.7	18.4
A-39	A_HSCT2_1	0.13	25.4	4.0
A-39	A_SHSC_1	0.25	25.4	5.2
A-39	A_THC1_1	0.16	17.0	3.3
A-39	A_THC2_1	0.13	16.6	3.3
A-39	A_THC2_2	0.47	53.2	11.7
A-39	J_HSC_2	1.16	253.7	46.2
A-39	J_HSC_2,SHSC_1	1.41	277.5	51.4
A-39	J_HSC_3,HSCT1	0.79	232.7	38.7
A-39	J_HSCT1_1	0.51	167.6	26.5
A-39	J_HSCT1,2	0.39	147.1	22.4
A-39	J_THC2,THC1	0.62	69.0	15.0
A-39	R_FPT_1	0.44	142.5	22.9
A-39	R_HSC_1	1.41	274.6	51.4
A-39	R_HSC_2	0.79	222.8	38.7
A-39	R_HSCT1_1	0.39	144.6	22.4
A-39	R_THC2_1	0.62	68.9	15.0
A-39	S_FPT_1	0.87	231.9	19.8
A-39	S_HSC_1	1.49	283.0	54.3
A-39	S_THC2_1	0.75	84.4	18.2

FIGURES

This page was intentionally left blank.



Legend

- Study Area
- Major Road
- Railroad
- State Boundary
- County Boundary
- Corporate Boundary
- Military Boundary
- Park Boundary
- Designated Place
- Watershed Area

Elevation:

- 7,616
- 7,000
- 6,500
- 6,000
- 5,500
- 5,000
- 4,500
- 4,000

N

0 2 4 Miles

1 : 253,440 or 1 inch = 4 miles

Master Plan Study Areas
 El Paso County
 Stormwater Master Plan

August 2010 Figure A-1

File: P:\GIS\Projects\EP\CountySMP\MXD\Report\FA-1_MasterPlanStudyAreas.mxd

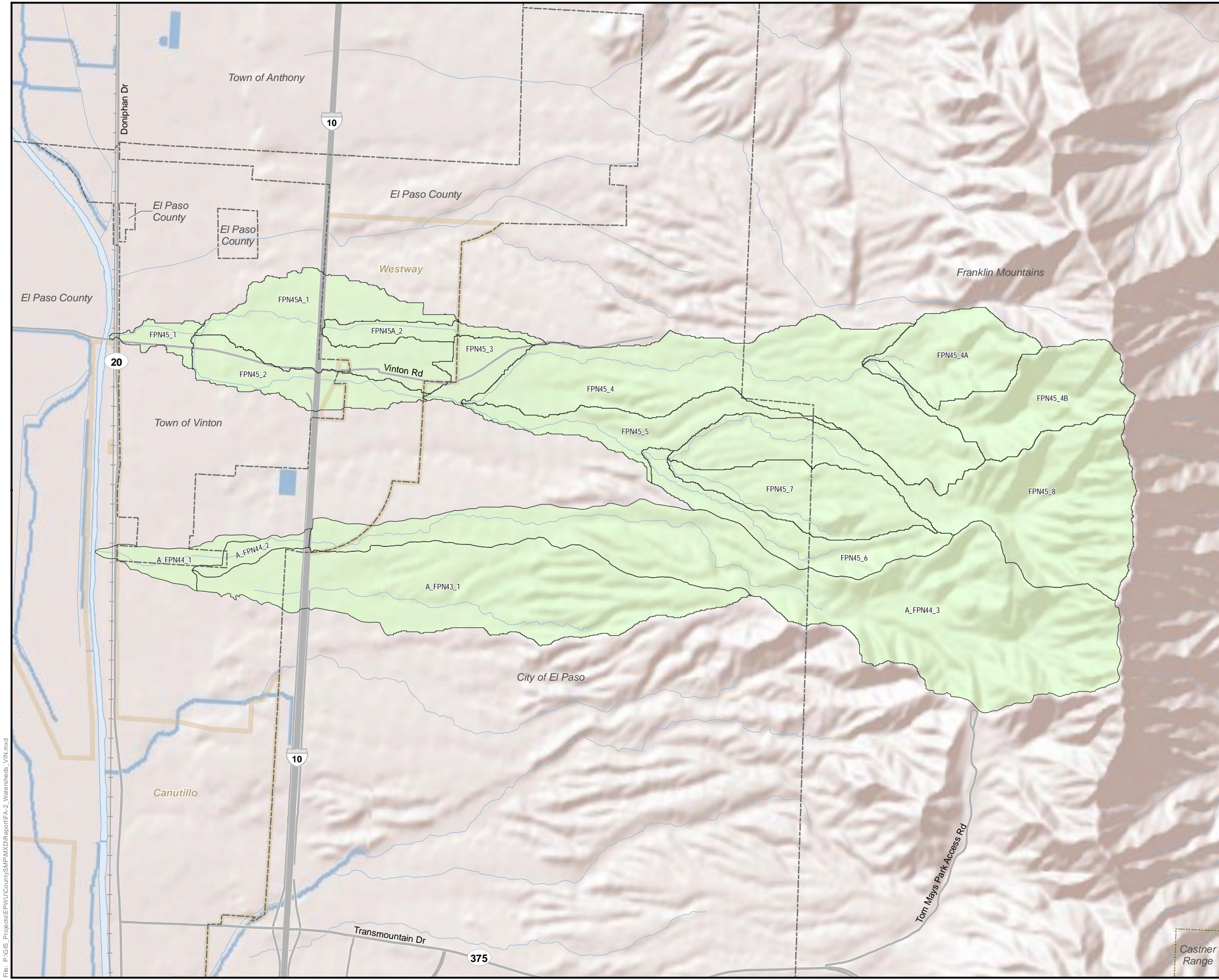

- Legend**
- Watershed
 - Major Road
 - Railroad
 - Streamline
 - Water Body
 - Corporate Boundary
 - Designated Place

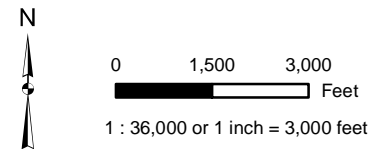

**Watershed Delineation
Vinton Study Area**
El Paso County
Stormwater Master Plan

August 2010 Figure A-2



File: P:\GIS_Projects\EP\U\CountySMP\MXD\Report\FA-2_Watersheds_VIN.mxd

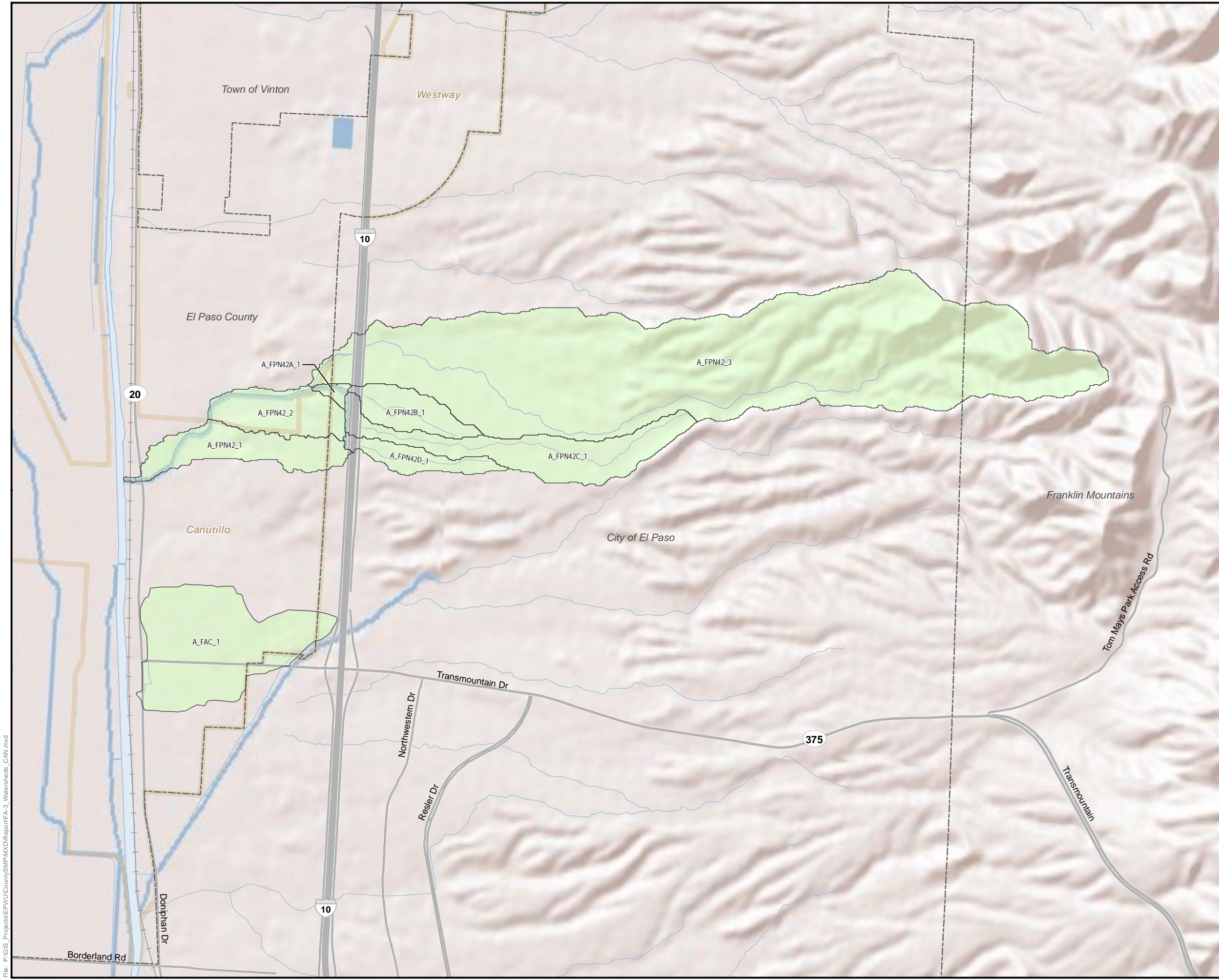

- Legend**
- Watershed
 - Major Road
 - Railroad
 - Streamline
 - Water Body
 - Corporate Boundary
 - Designated Place

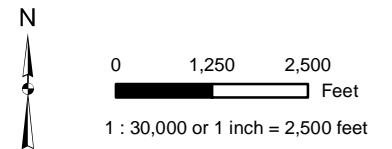

**Watershed Delineation
Canutillo Study Area**
El Paso County
Stormwater Master Plan

August 2010 Figure A-3



File: P:\GIS_Projects\EP\CountySMP\MXD\Report\FA-3_Watersheds_CAN.mxd

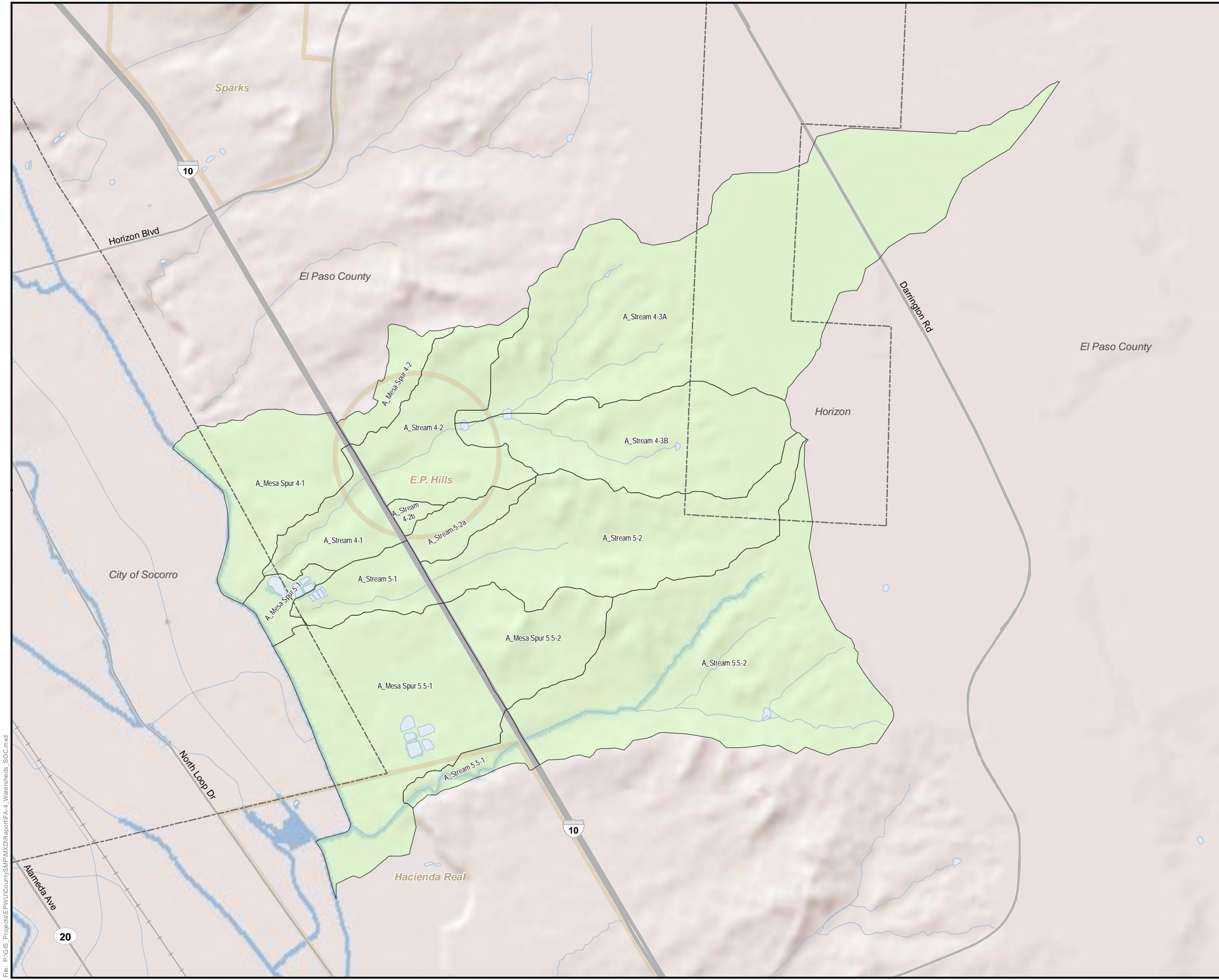

- Legend**
- Watershed
 - Major Road
 - Railroad
 - Streamline
 - Water Body
 - Corporate Boundary
 - Designated Place

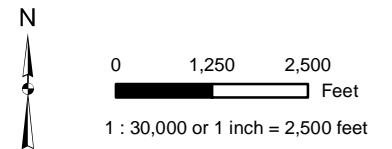

**Watershed Delineation
Socorro Study Area**
El Paso County
Stormwater Master Plan

August 2010 Figure A-4



File: P:\GIS_Projects\EP\CountySMP\MXD\Report\FA-4_Watersheds_SOC.mxd

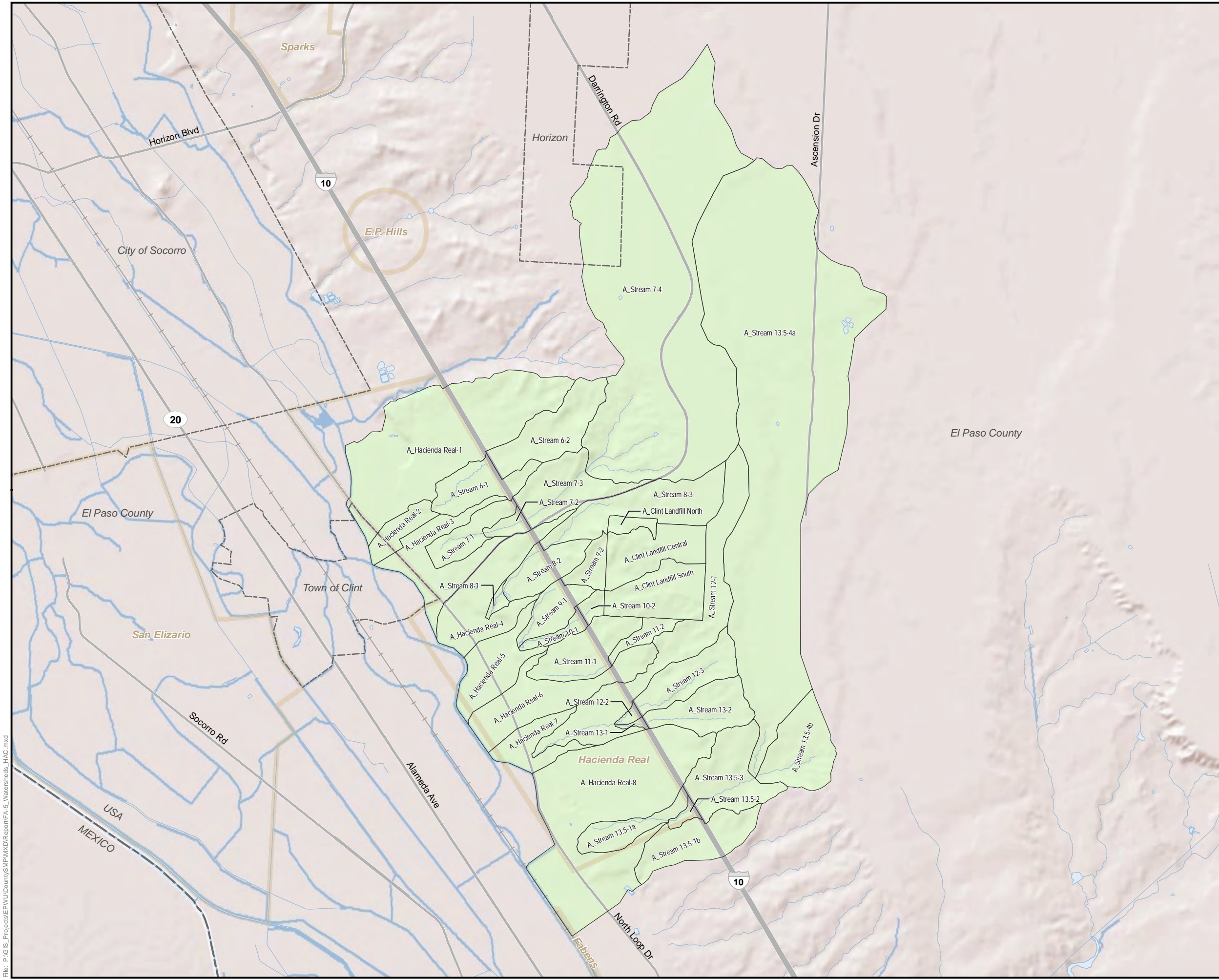

- Legend**
- Watershed
 - Major Road
 - Railroad
 - Streamline
 - Water Body
 - State Boundary
 - Corporate Boundary
 - Designated Place

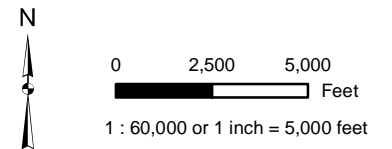

**Watershed Delineation
Hacienda Real Study Area**
El Paso County
Stormwater Master Plan

August 2010 Figure A-5



File: P:\GIS_P\Projects\EP\U\County\SMP\MXD\Report\FA-5_Watersheds_HAC.mxd

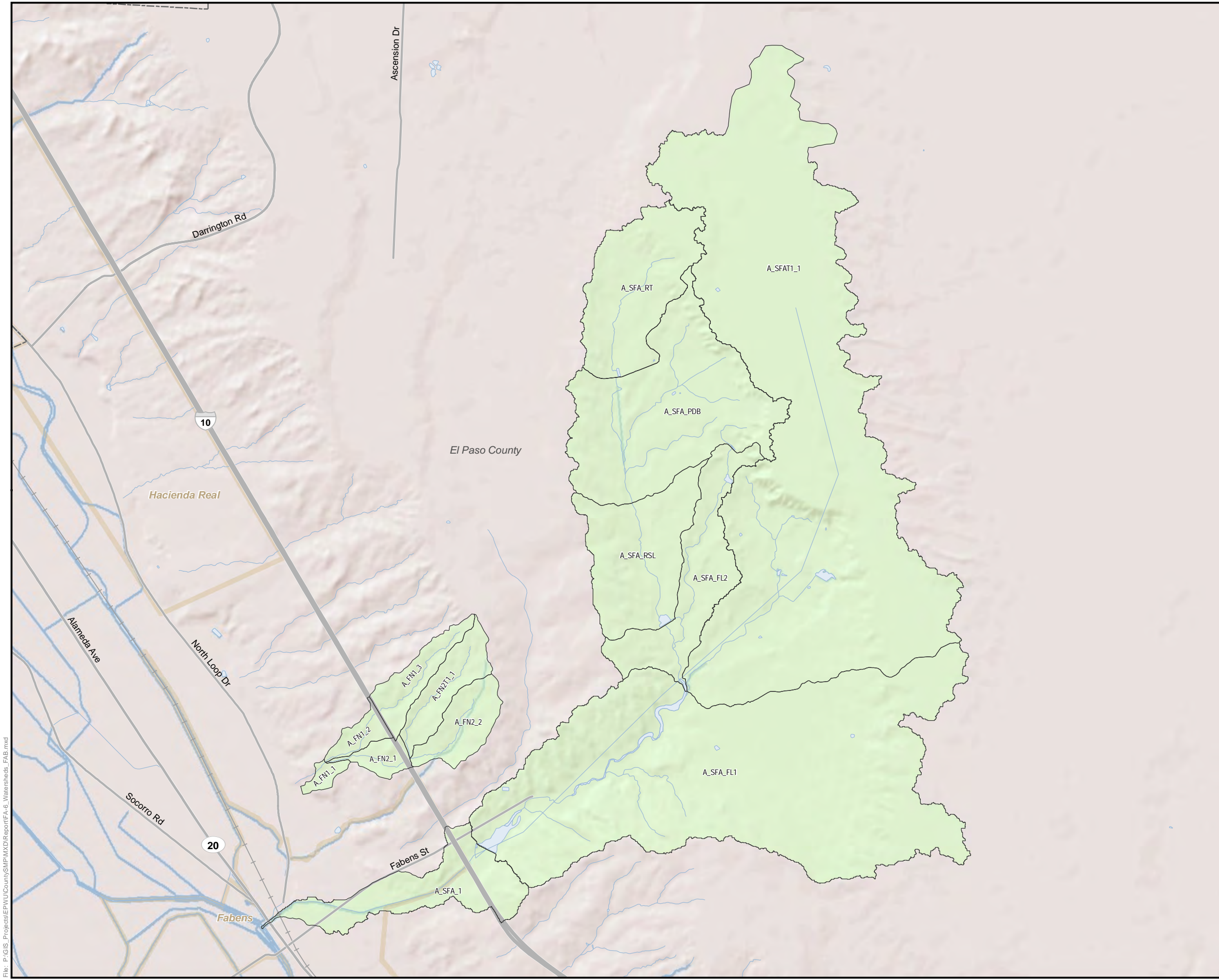

- Legend**
- Watershed
 - Major Road
 - Railroad
 - Streamline
 - Water Body
 - Corporate Boundary
 - Designated Place

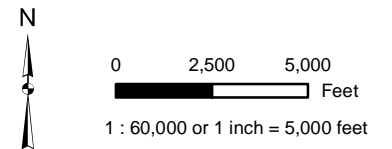

**Watershed Delineation
Fabens Study Area**
El Paso County
Stormwater Master Plan

August 2010 Figure A-6



File: P:\GIS_Projects\EP\U\CountySMP\MXD\Report\FA-6_Watersheds_FAB.mxd

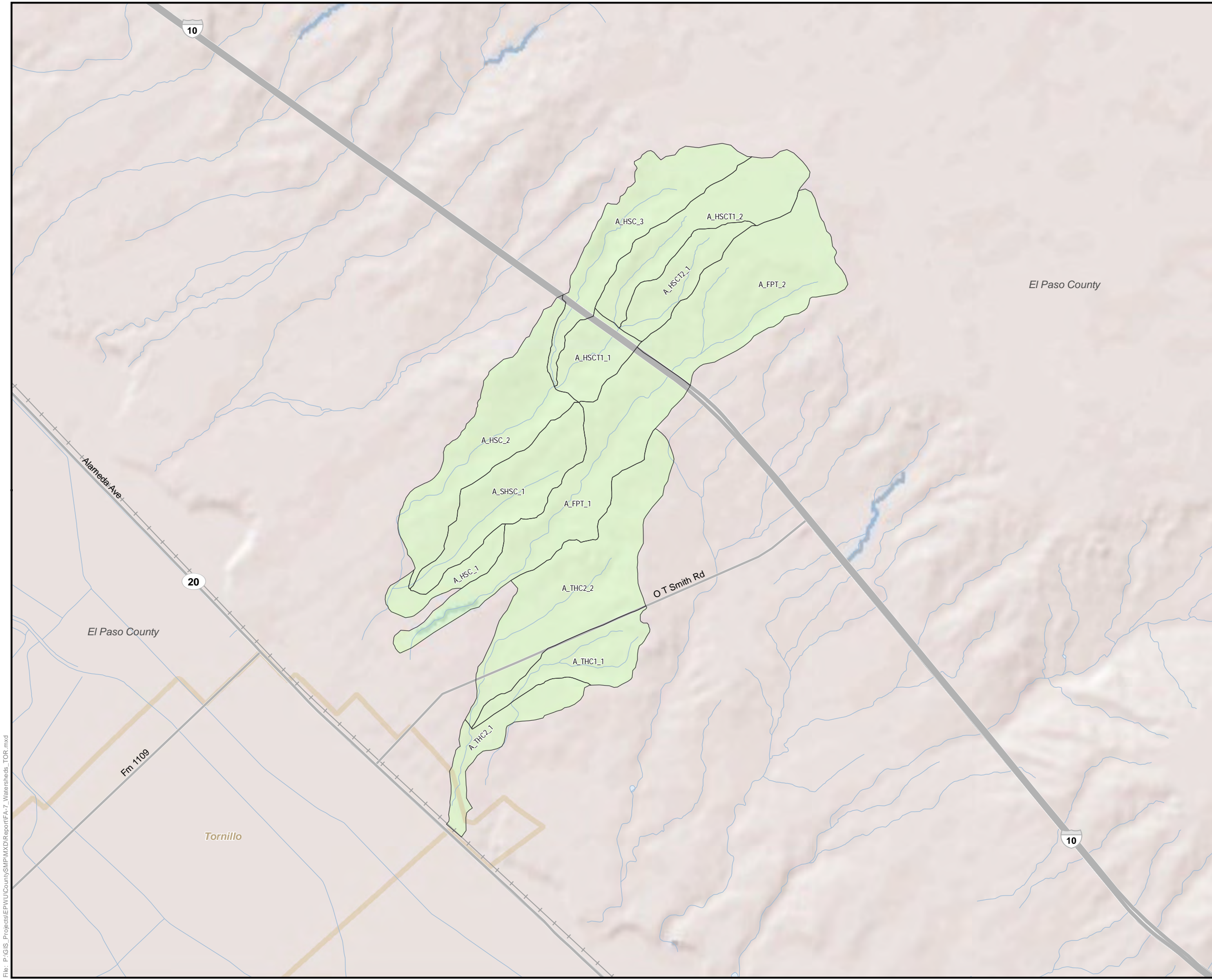

- Legend**
- Watershed
 - Major Road
 - Railroad
 - Streamline
 - Water Body
 - Corporate Boundary
 - Designated Place

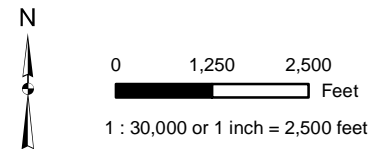

**Watershed Delineation
Tornillo Study Area**
El Paso County
Stormwater Master Plan

August 2010 Figure A-7



File: P:\GIS_Projects\EP\U\CountySMP\MXD\Report\FA-7_Watersheds_TOR.mxd

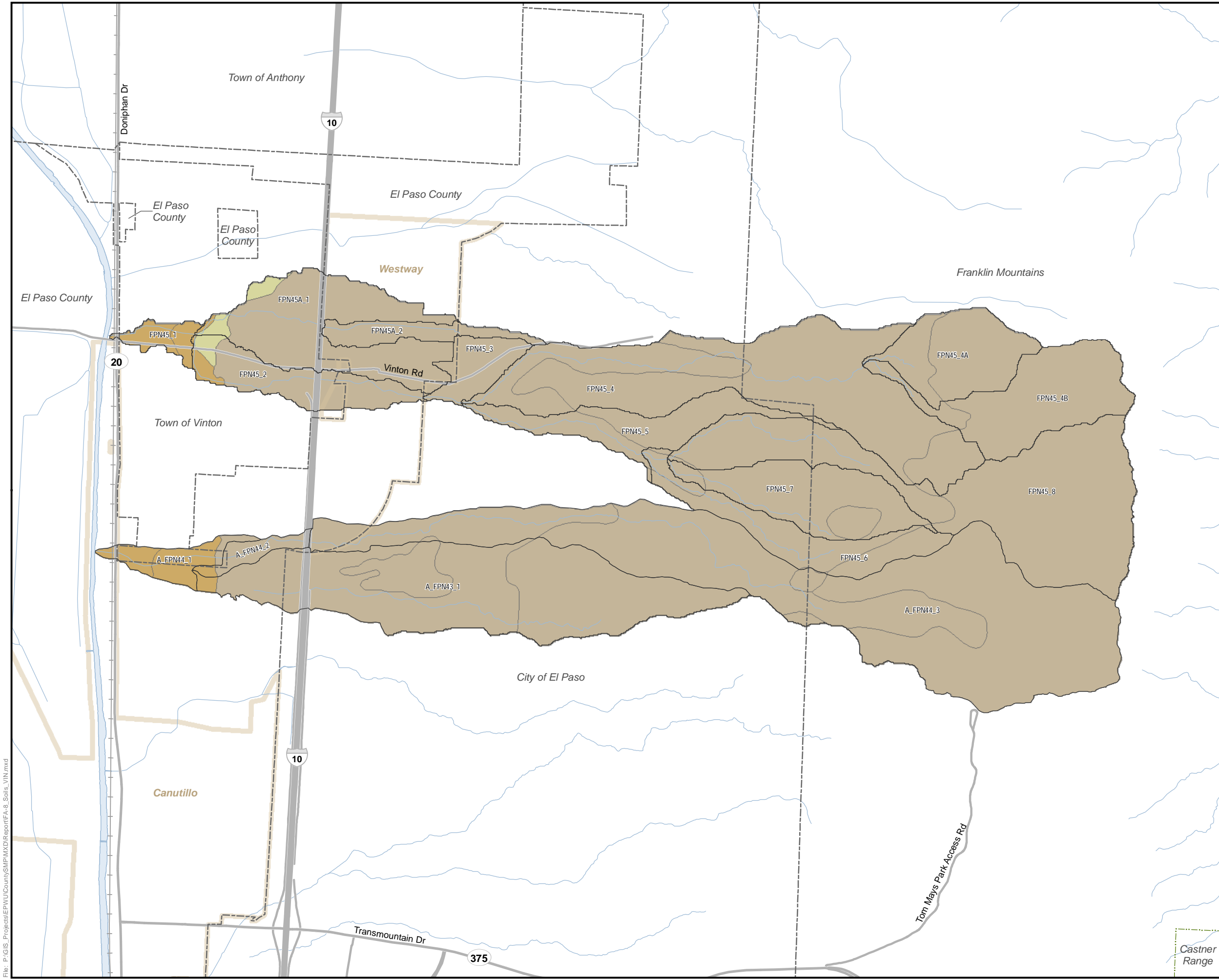

- Legend**
- Hydrologic Soil Group
- A
 - B
 - D
- Watershed
 - Major Road
 - Railroad
 - Streamline
 - Water Body
 - Corporate Boundary
 - Designated Place

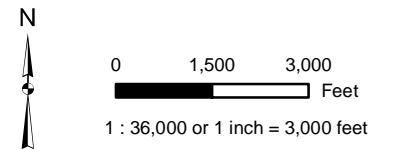

**Hydrologic Soil Groups Map
Vinton Study Area**
El Paso County
Stormwater Master Plan

August 2010 Figure A-8



File: P:\GIS_Projects\EP\U\CountySMP\MXD\Report\FA-8_Soils_VIN.mxd

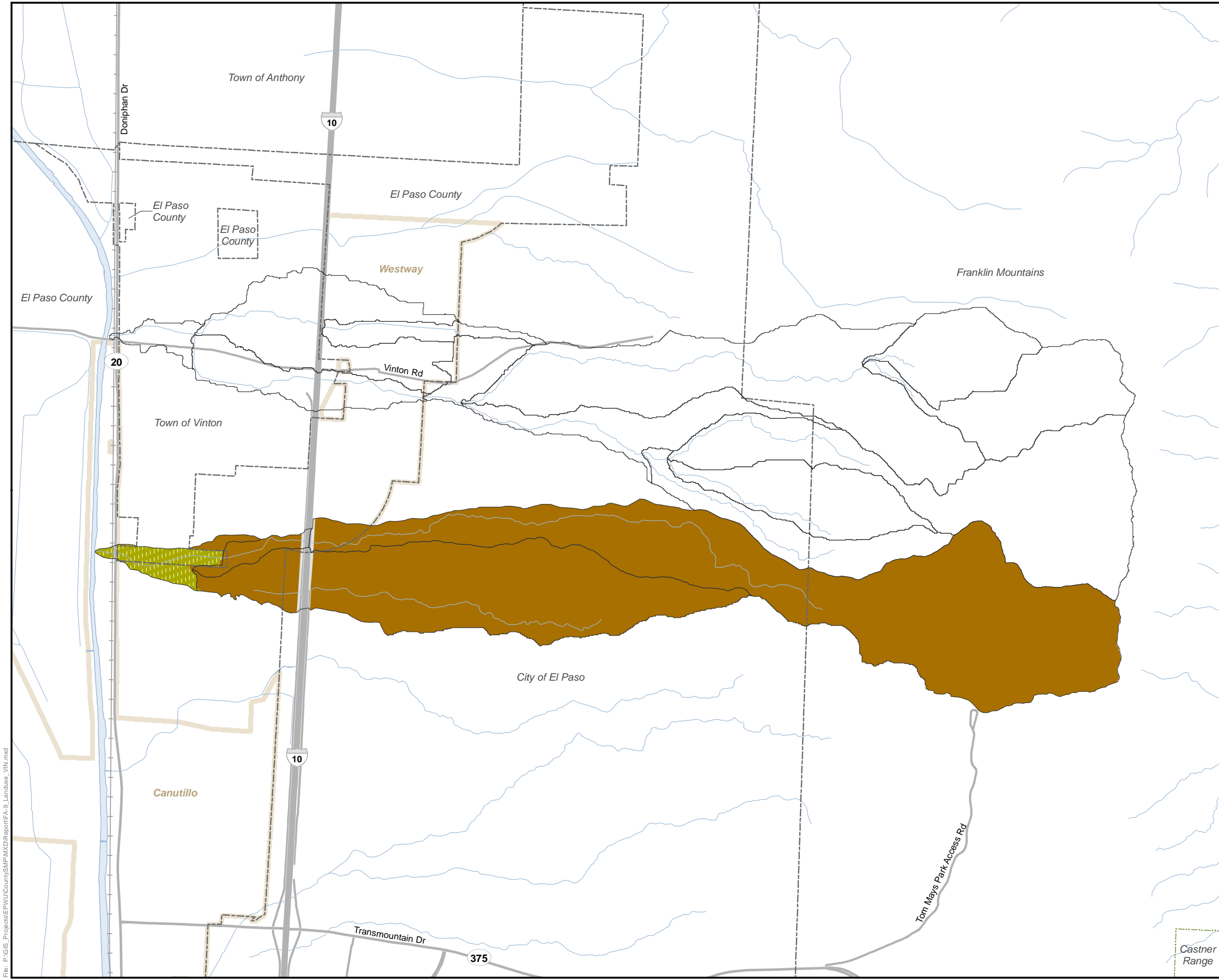

- Legend**
- Land Use:
- Desert Shrub (good)
 - Highway
 - Residential (1 acre)
- Watershed
 Major Road
++ Railroad
 Streamline
 Water Body
 Corporate Boundary
 Designated Place

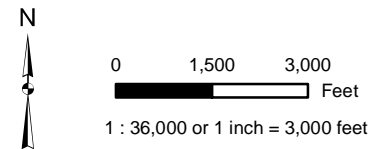

**Land Use Map
Vinton Study Area
El Paso County
Stormwater Master Plan**

August 2010 Figure A-9



File: P:\GIS_Projects\EP\U\CountySMP\MXD\Report\FA-9_Landuse_VIN.mxd

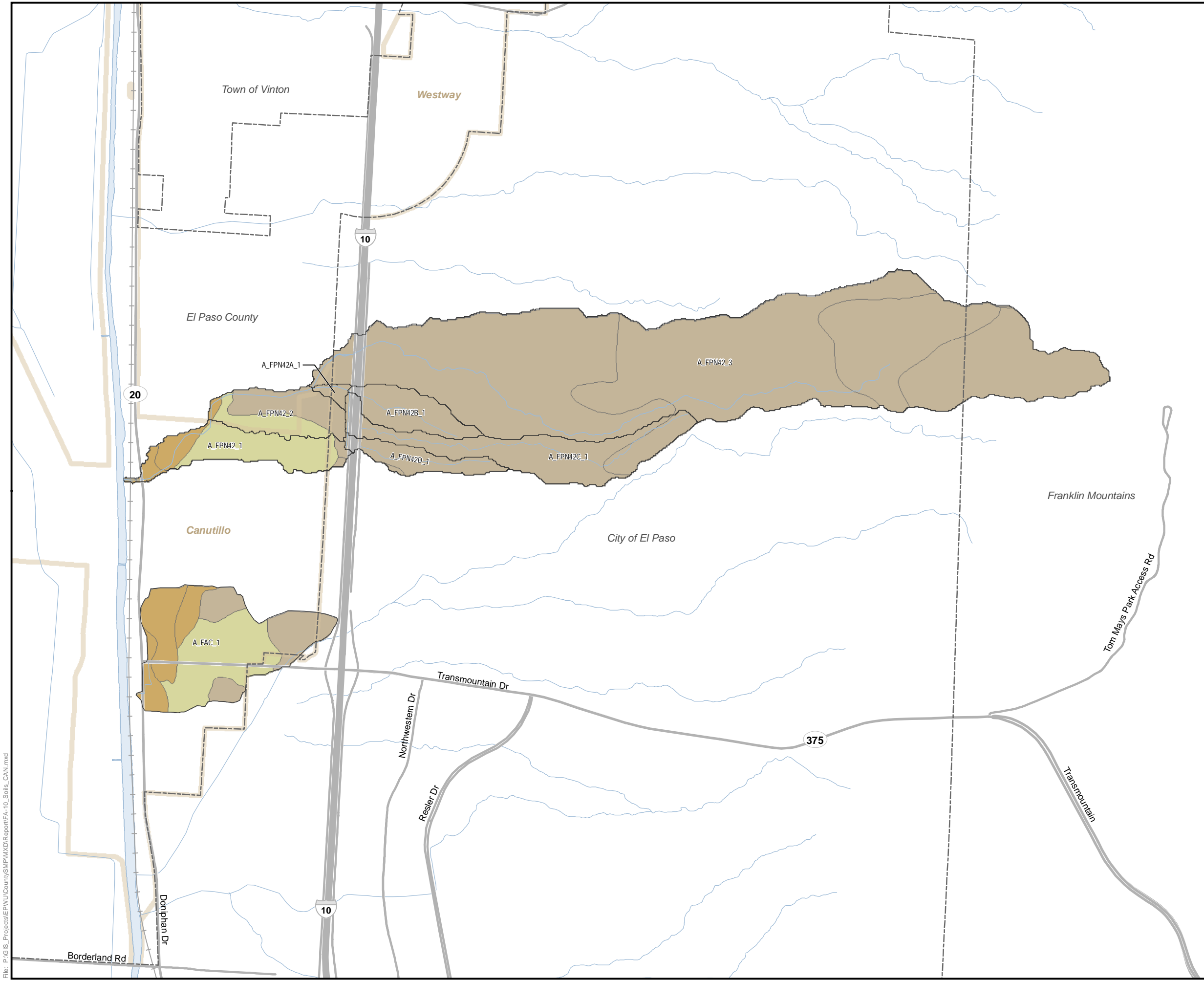

- Legend**
- Hydrologic Soil Group
- A
 - B
 - D
- Watershed
 - Major Road
 - Railroad
 - Streamline
 - Water Body
 - Corporate Boundary
 - Designated Place

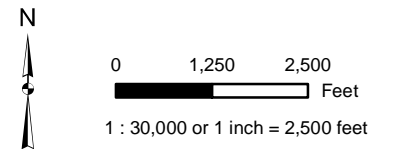

**Hydrologic Soil Groups Map
Canutillo Study Area**
El Paso County
Stormwater Master Plan

August 2010 Figure A-10



File: P:\GIS_Projects\EP\U\County\SMP\MXD\Report\FA-10_Soils_CAN.mxd

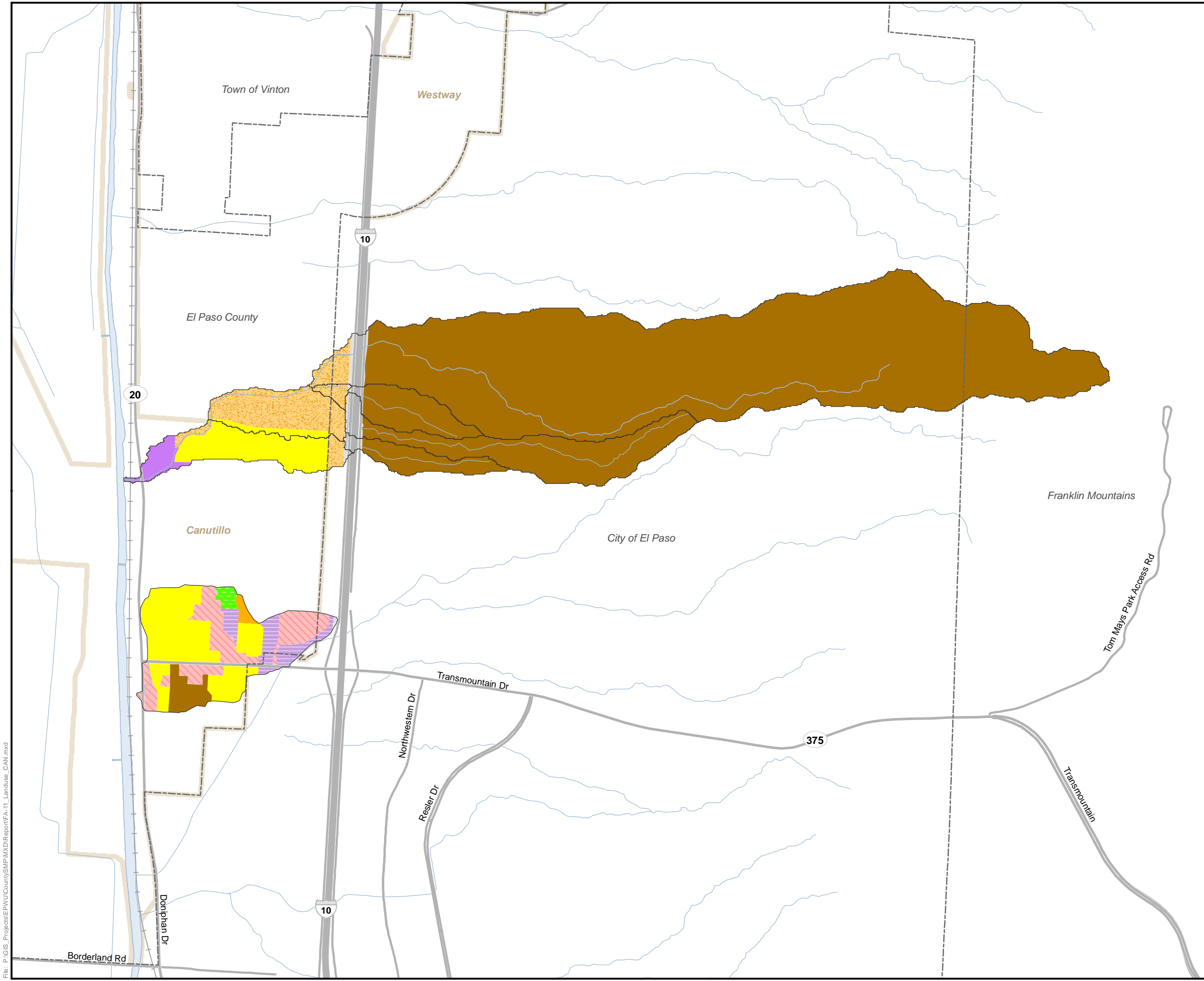

Legend

Land Use:

- Commercial and Business
- Desert Shrub (good)
- Desert Shrub (fair)
- Desert Shrub (poor)
- Highway
- Industrial
- Newly Graded
- Open Space (fair)
- Residential (1/4 acre)

- Watershed
- Major Road
- Railroad
- Streamline
- Water Body
- Corporate Boundary
- Designated Place

N

0 1,250 2,500 Feet

1 : 30,000 or 1 inch = 2,500 feet

Land Use Map
Canutillo Study Area
 El Paso County
 Stormwater Master Plan

August 2010 Figure A-11

File: P:\GIS_Projects\EP\U\CountySMP\MXD\Report\FA-11_Landuse_CAN.mxd

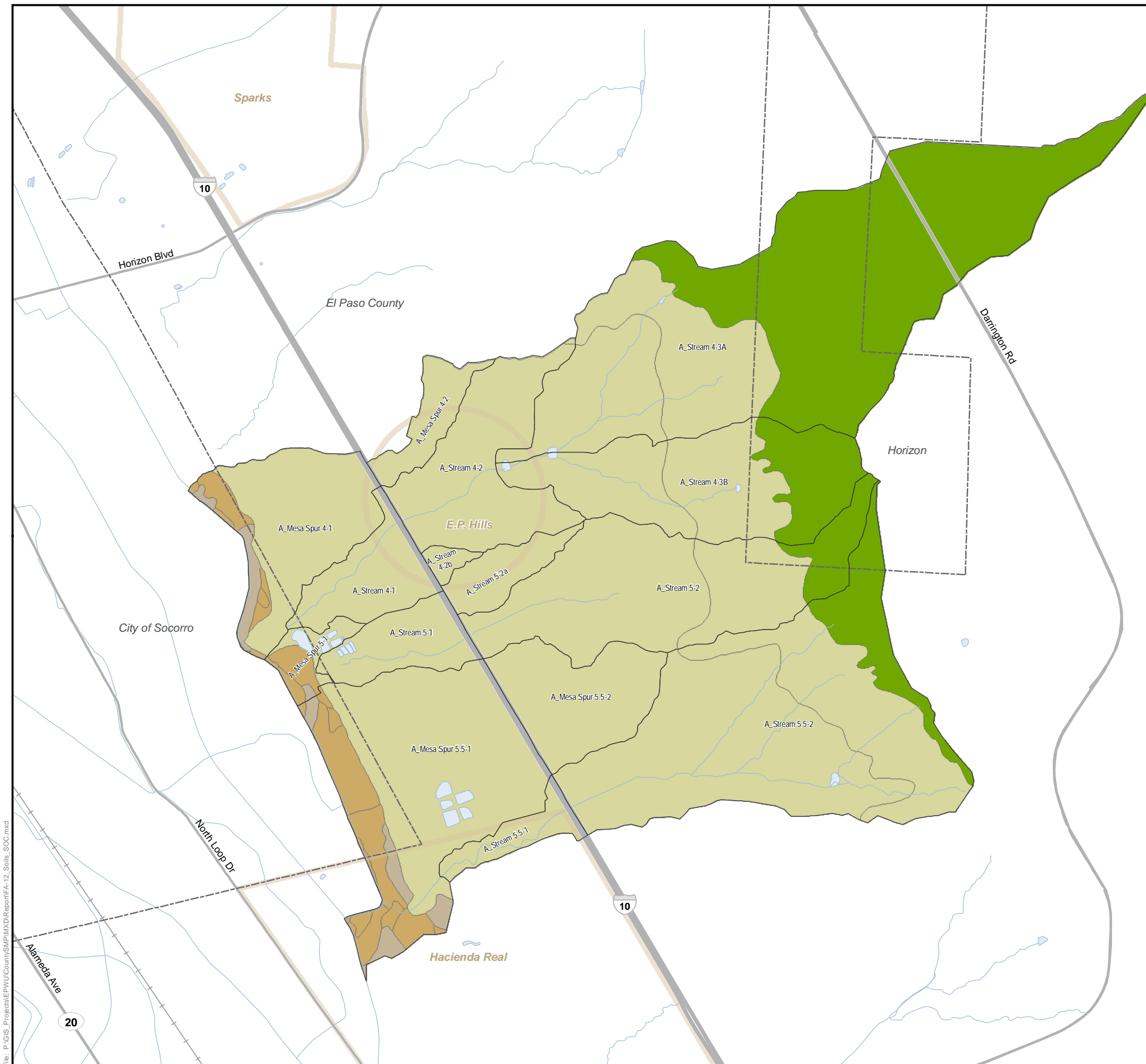

Legend

Hydrologic Soil Group

- A
- B
- C
- D

- Watershed
- Major Road
- Railroad
- Streamline
- Water Body
- Corporate Boundary
- Designated Place



0 1,250 2,500
 Feet
 1 : 30,000 or 1 inch = 2,500 feet

**Hydrologic Soil Groups Map
 Socorro Study Area**
 El Paso County
 Stormwater Master Plan

August 2010

Figure A-12



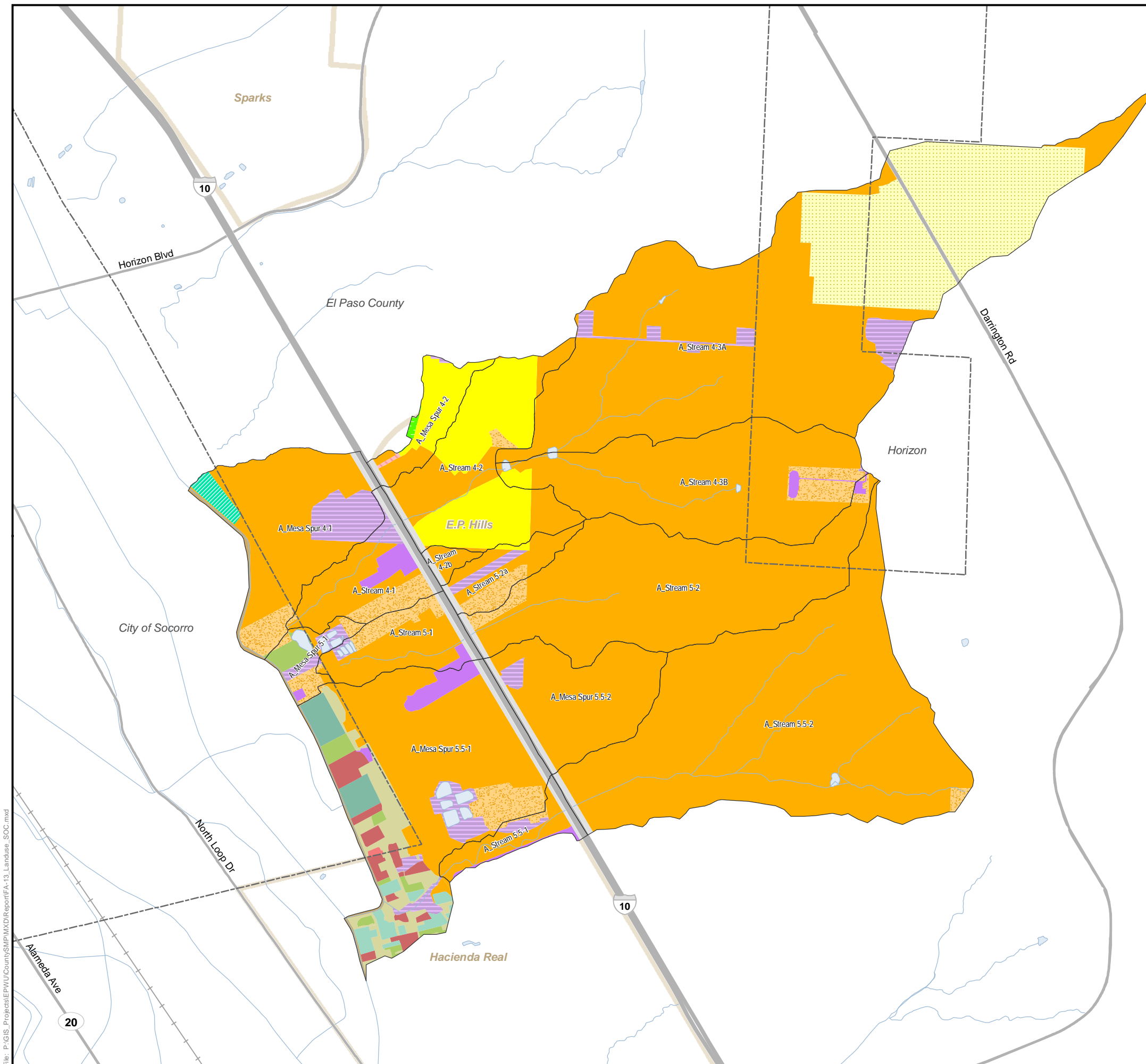

Legend

Land Use:

- Brush (fair)
- Commercial and Business
- Desert Shrub (fair)
- Desert Shrub (poor)
- Farmsteads
- Highway
- Industrial
- Meadow (fair)
- Meadow (Good)
- Newly Graded
- Open Space (good)
- Open Space (fair)
- Pasture, Grassland, or Range (poor)
- Pasture, Grassland, or Range (fair)
- Residential (1/4 acre)
- Residential (1/8 acres or less, townhouses)
- Straight Row Crops (good)
- Woods

Watershed
 Major Road
 Railroad
 Streamline
 Water Body
 Corporate Boundary
 Designated Place

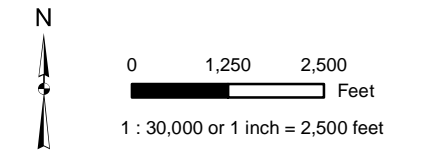

Land Use Map
Socorro Study Area
 El Paso County
 Stormwater Master Plan

August 2010 Figure A-13



File: P:\GIS_Projects\EP\CountySMP\MXD\Report\FA-13_Landuse_SOC.mxd

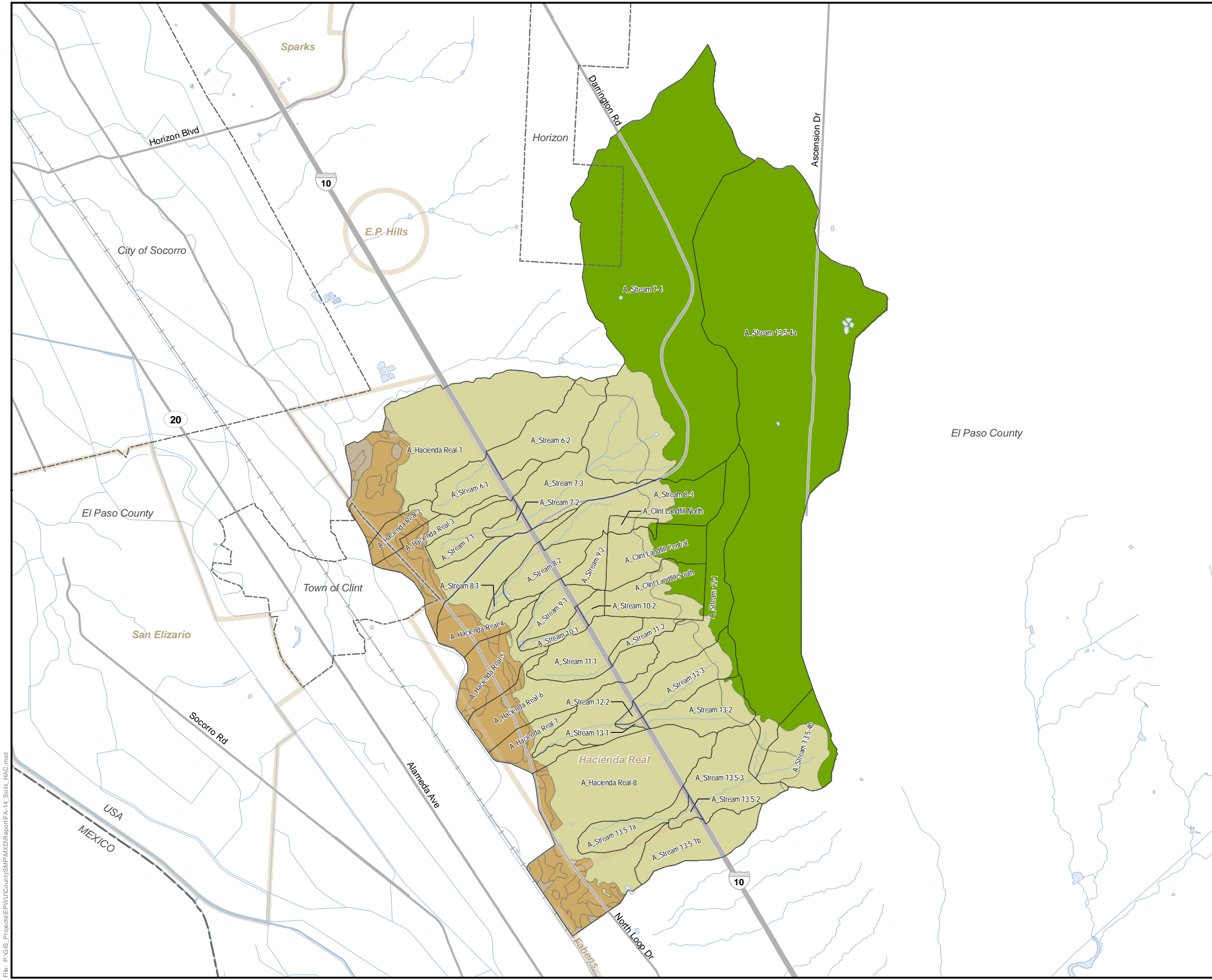

Legend

Hydrologic Soil Group

- A
- B
- C
- D

- Watershed
- Major Road
- Railroad
- Streamline
- Water Body
- State Boundary
- Corporate Boundary
- Designated Place

N

0 2,500 5,000
Feet

1 : 60,000 or 1 inch = 5,000 feet

Hydrologic Soil Groups Map
Hacienda Real Study Area
 El Paso County
 Stormwater Master Plan

August 2010 Figure A-14



File: P:\GIS_Projects\EP\U\County\SMP\MXD\Report\FA-14_Soils_HAC.mxd

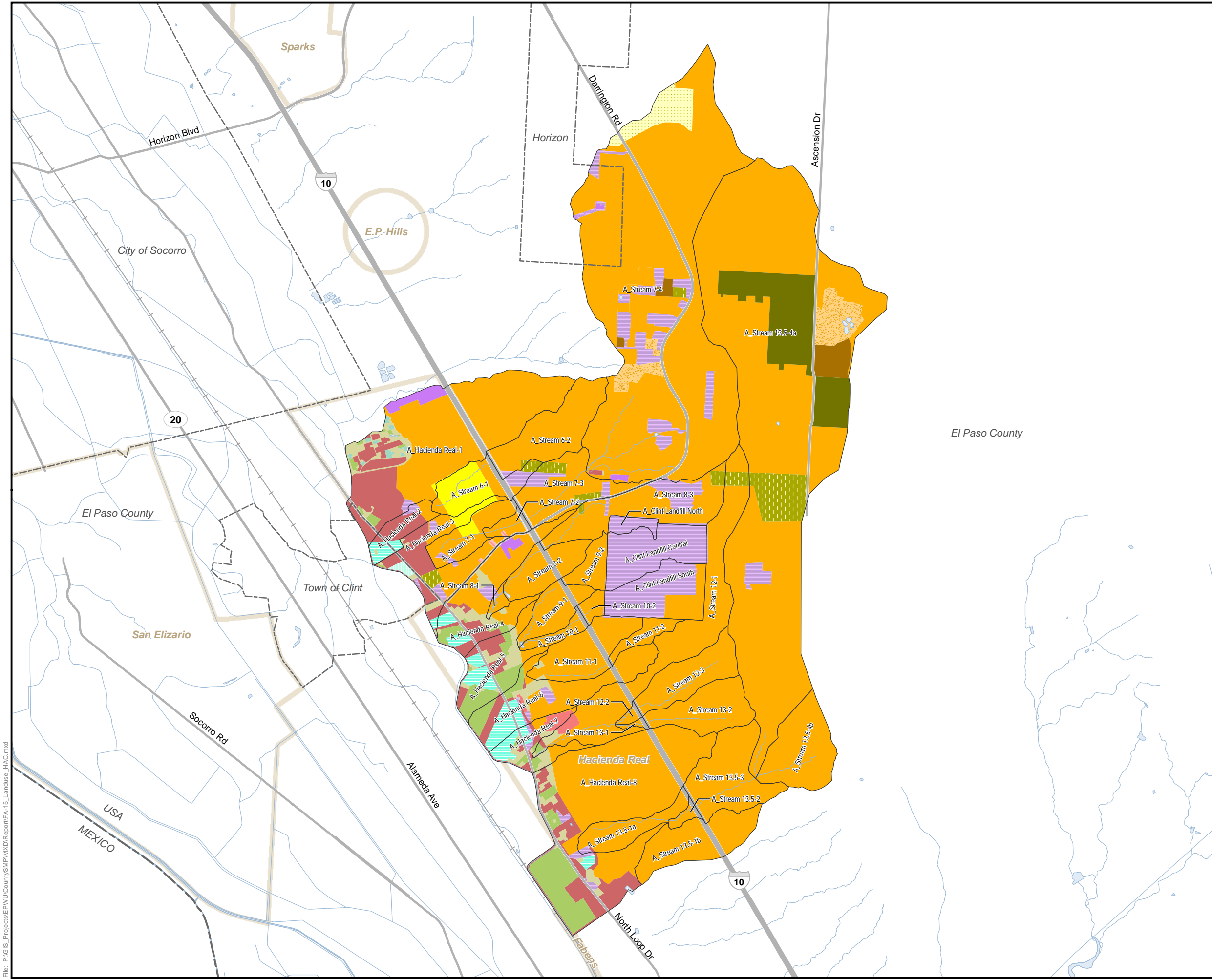

Legend

Land Use:

- Brush (fair)
- Commercial and Business
- Desert Shrub (good)
- Desert Shrub (fair)
- Desert Shrub (poor)
- Farmsteads
- Highway
- Industrial
- Meadow (fair)
- Newly Graded
- Pasture, Grassland, or Range (poor)
- Pasture, Grassland, or Range (fair)
- Residential (2 acres)
- Residential (1 acre)
- Residential (1/4 acre)
- Residential (1/8 acres or less, townhouses)
- Straight Row Crops (poor)
- Straight Row Crops (fair)
- Woods

Watershed
 Major Road
 Railroad
 Streamline
 Water Body
 State Boundary
 Corporate Boundary
 Designated Place

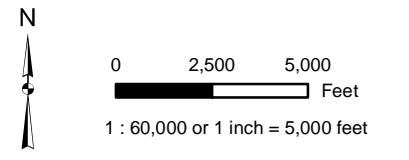

Land Use Map
Hacienda Real Study Area
 El Paso County
 Stormwater Master Plan

August 2010 Figure A-15



File: P:\GIS_Projects\EP\U\County\SMP\MXD\Report\FA-15_Landuse_HAC.mxd

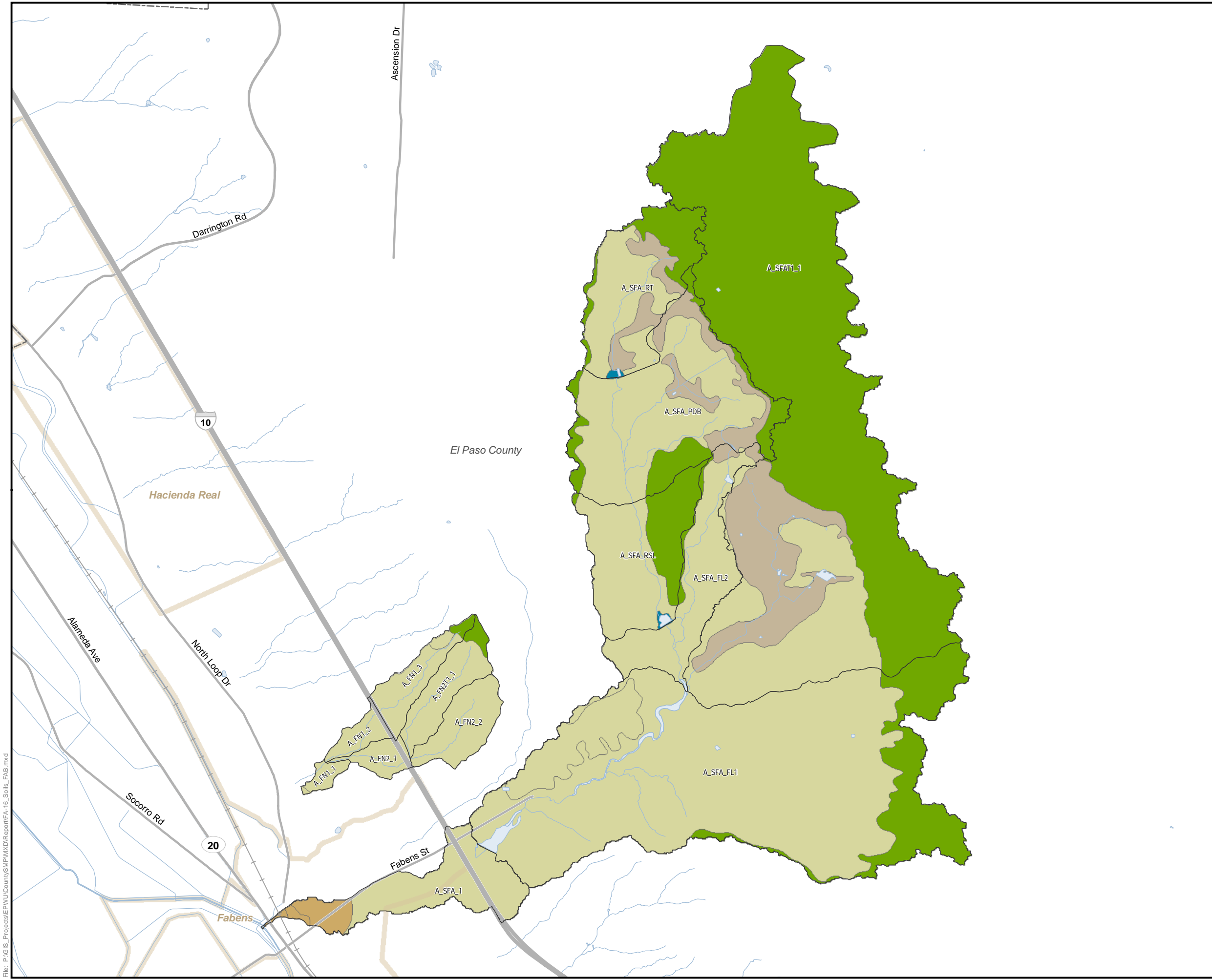

Legend

Hydrologic Soil Group

- A
- B
- C
- D
- W

- Watershed
- Major Road
- Railroad
- Streamline
- Water Body
- Corporate Boundary
- Designated Place

N

0 2,500 5,000
Feet

1 : 60,000 or 1 inch = 5,000 feet

Hydrologic Soil Groups Map
Fabens Study Area
 El Paso County
 Stormwater Master Plan

August 2010 Figure A-16



File: P:\GIS_Projects\EP\U\CountySMP\MXD\Report\FA-16_Soils_FAB.mxd

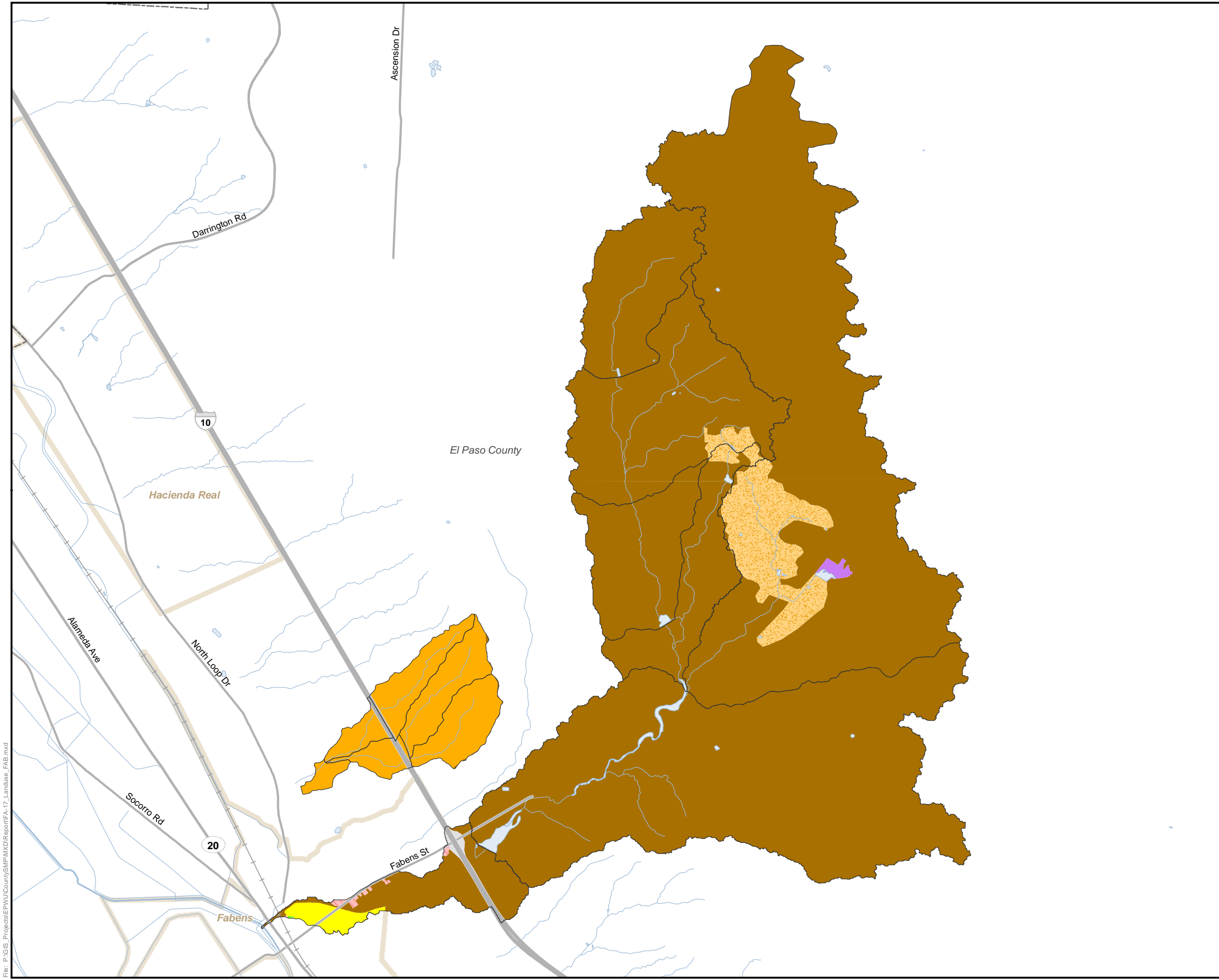

- Legend**
- Land Use:
- Commercial and Business
 - Desert Shrub (good)
 - Desert Shrub (fair)
 - Desert Shrub (poor)
 - Highway
 - Industrial
 - Open Space (fair)
 - Residential (1/4 acre)
- Watershed
 - Major Road
 - Railroad
 - Streamline
 - Water Body
 - Corporate Boundary
 - Designated Place

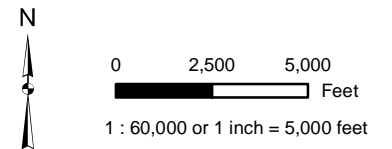

Land Use Map
Fabens Study Area
 El Paso County
 Stormwater Master Plan

August 2010 Figure A-17



File: P:\GIS_Projects\EP\U\CountySMP\MXD\Report\FA-17_Landuse_FAB.mxd

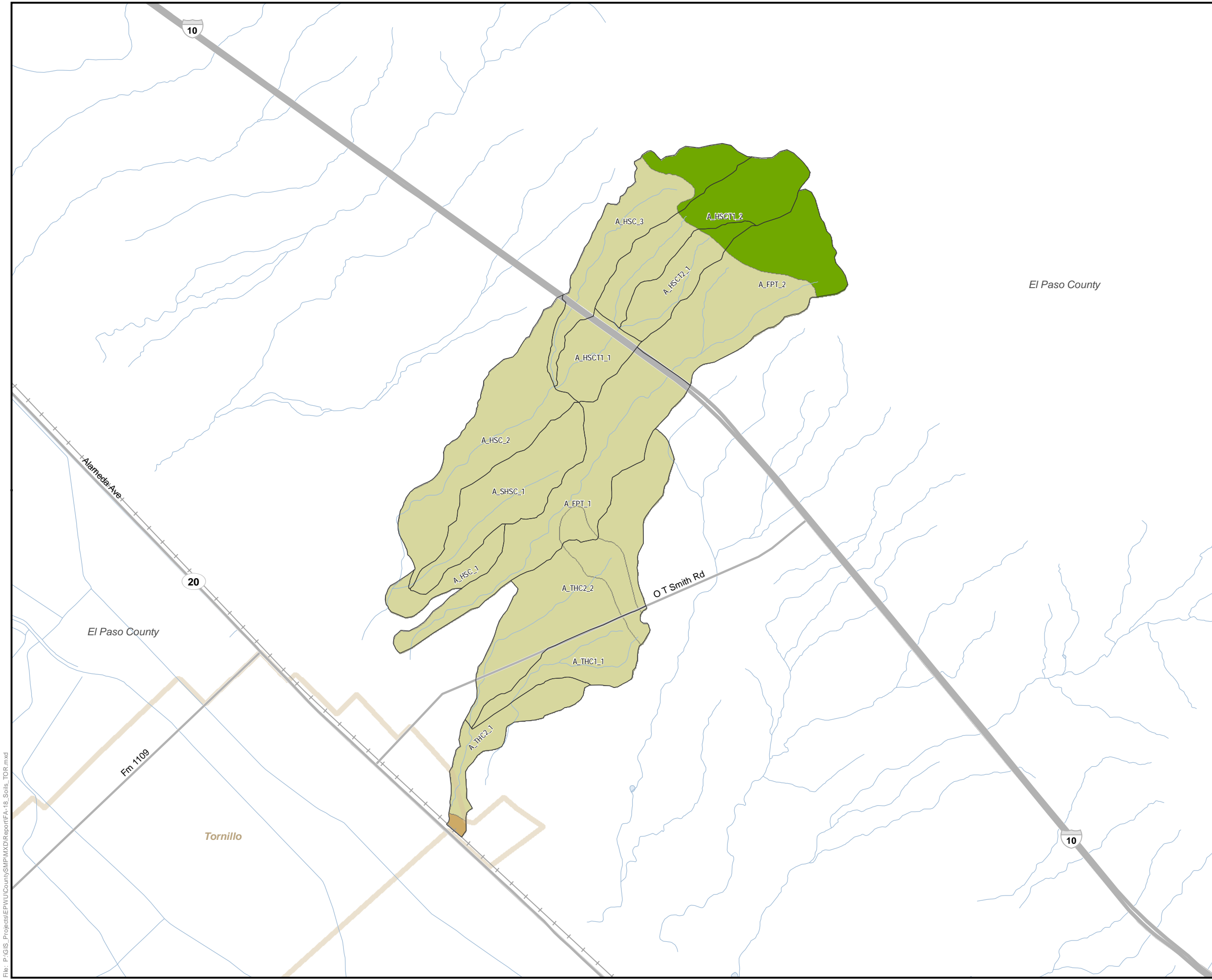

Legend

Hydrologic Soil Group

- A
- B
- C

- Watershed
- Major Road
- Railroad
- Streamline
- Water Body
- Corporate Boundary
- Designated Place

N

0 1,250 2,500
Feet

1 : 30,000 or 1 inch = 2,500 feet

Hydrologic Soil Groups Map
Tornillo Study Area
 El Paso County
 Stormwater Master Plan

August 2010 Figure A-18



File: P:\GIS_Projects\EP\U\CountySMP\MXD\Report\FA-18_Soils_TOR.mxd

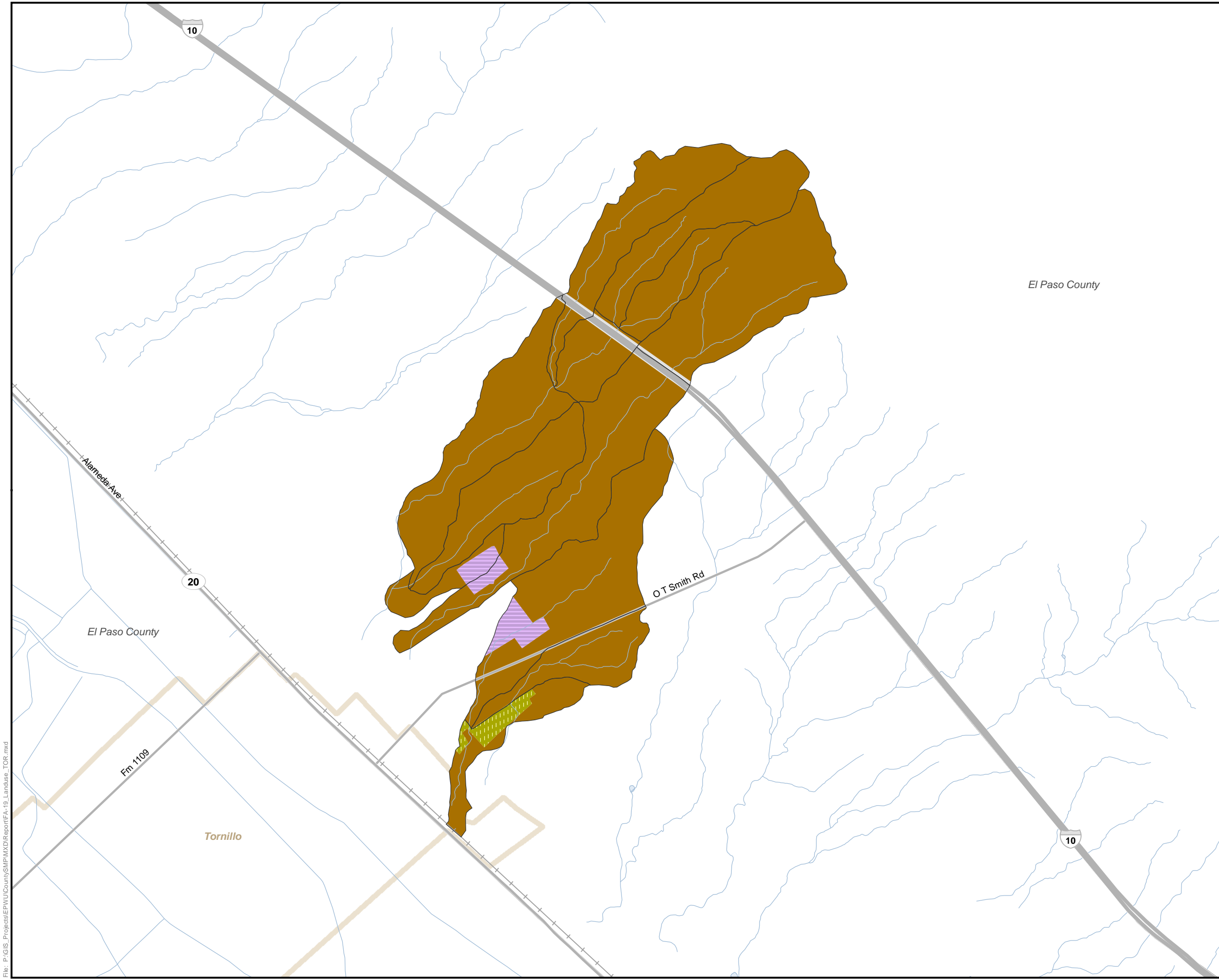

- Legend**
- Land Use:
- Desert Shrub (good)
 - Highway
 - Newly Graded
 - Residential (1 acre)
- Watershed
 - Major Road
 - ++ Railroad
 - Streamline
 - Water Body
 - Corporate Boundary
 - Designated Place

El Paso County

El Paso County

Tornillo

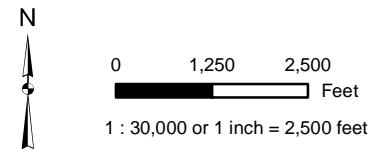

Land Use Map
Tornillo Study Area
 El Paso County
 Stormwater Master Plan

August 2010 Figure A-19



File: P:\GIS_Projects\EP\U\CountySMP\MXD\Report\FA-19_Landuse_TOR.mxd

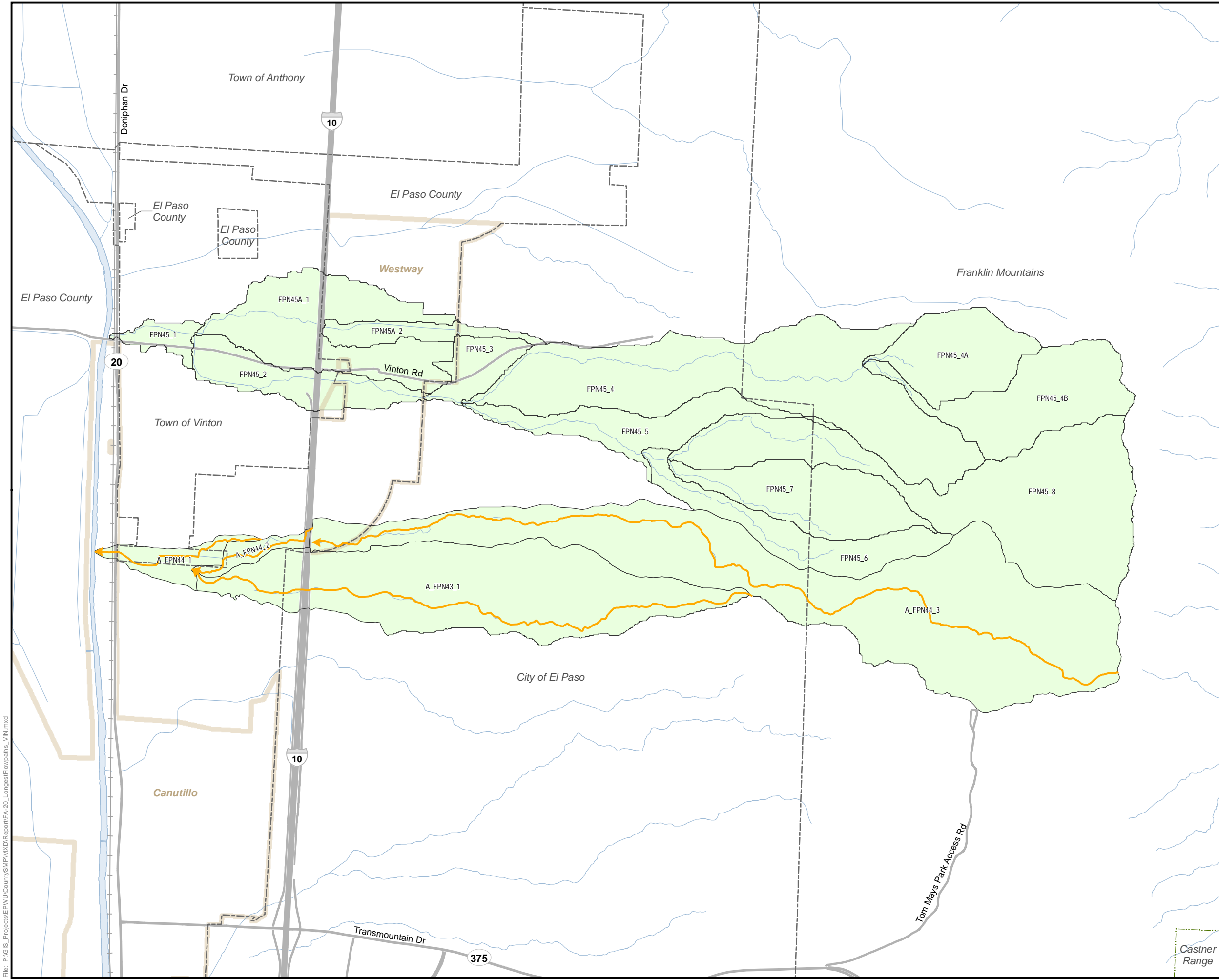

- Legend**
- Longest Flowpath
 - Watershed
 - Major Road
 - Railroad
 - Streamline
 - Water Body
 - Corporate Boundary
 - Designated Place

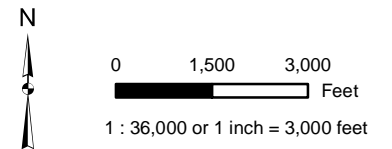

**Longest Flowpaths
Vinton Study Area**
El Paso County
Stormwater Master Plan

August 2010 Figure A-20



File: P:\GIS_Projects\EP\U\County\SMP\MXD\Report\FA-20_LongestFlowpaths_VIN.mxd

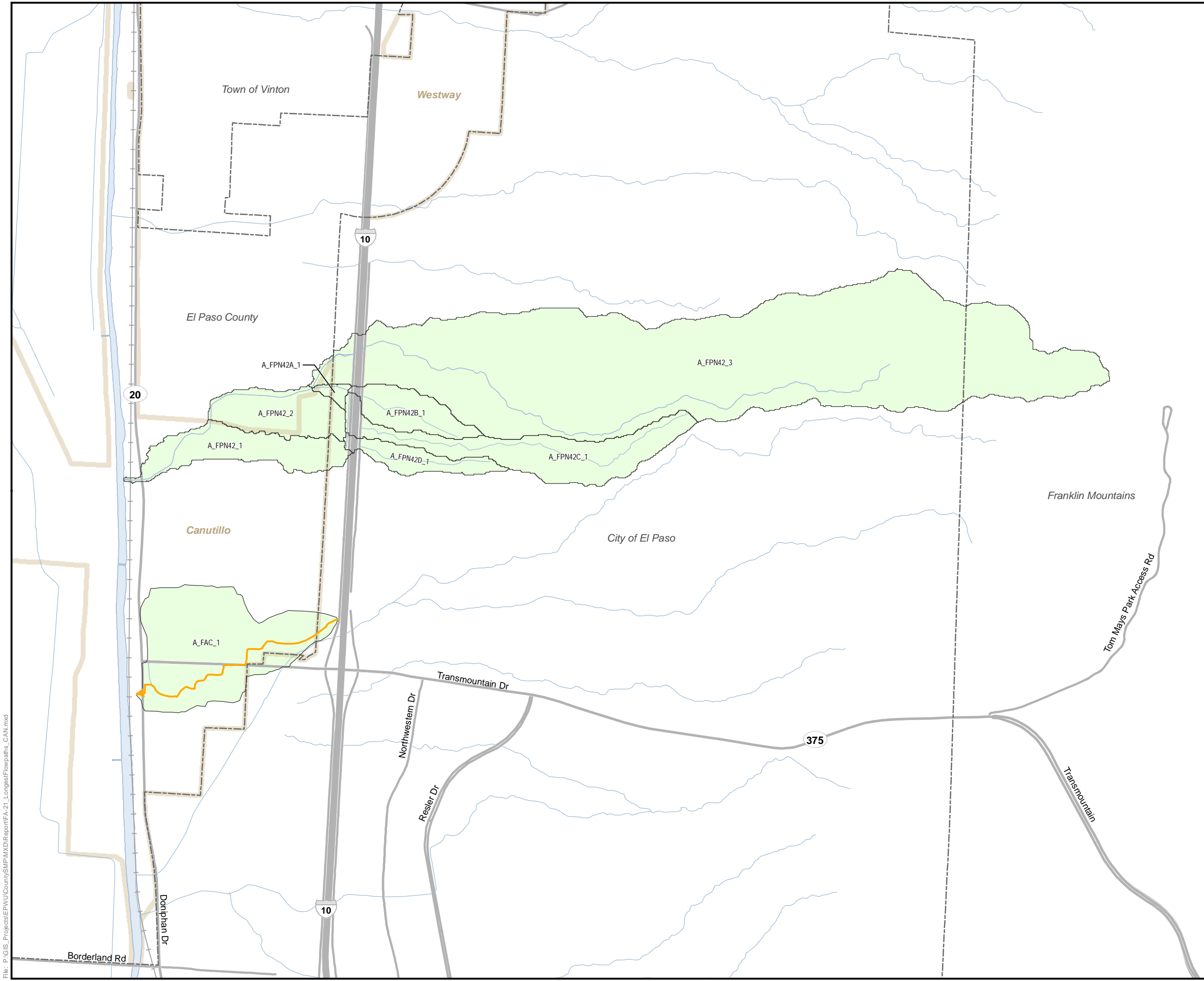

- Legend**
- Longest Flowpath
 - Watershed
 - Major Road
 - Railroad
 - Streamline
 - Water Body
 - Corporate Boundary
 - Designated Place

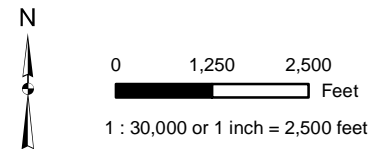

**Longest Flowpaths
Canutillo Study Area**
El Paso County
Stormwater Master Plan

August 2010 Figure A-21



File: P:\GIS_Projects\EP\U\County\SMP\MXD\Report\FA-21_LongestFlowpaths_CAN.mxd

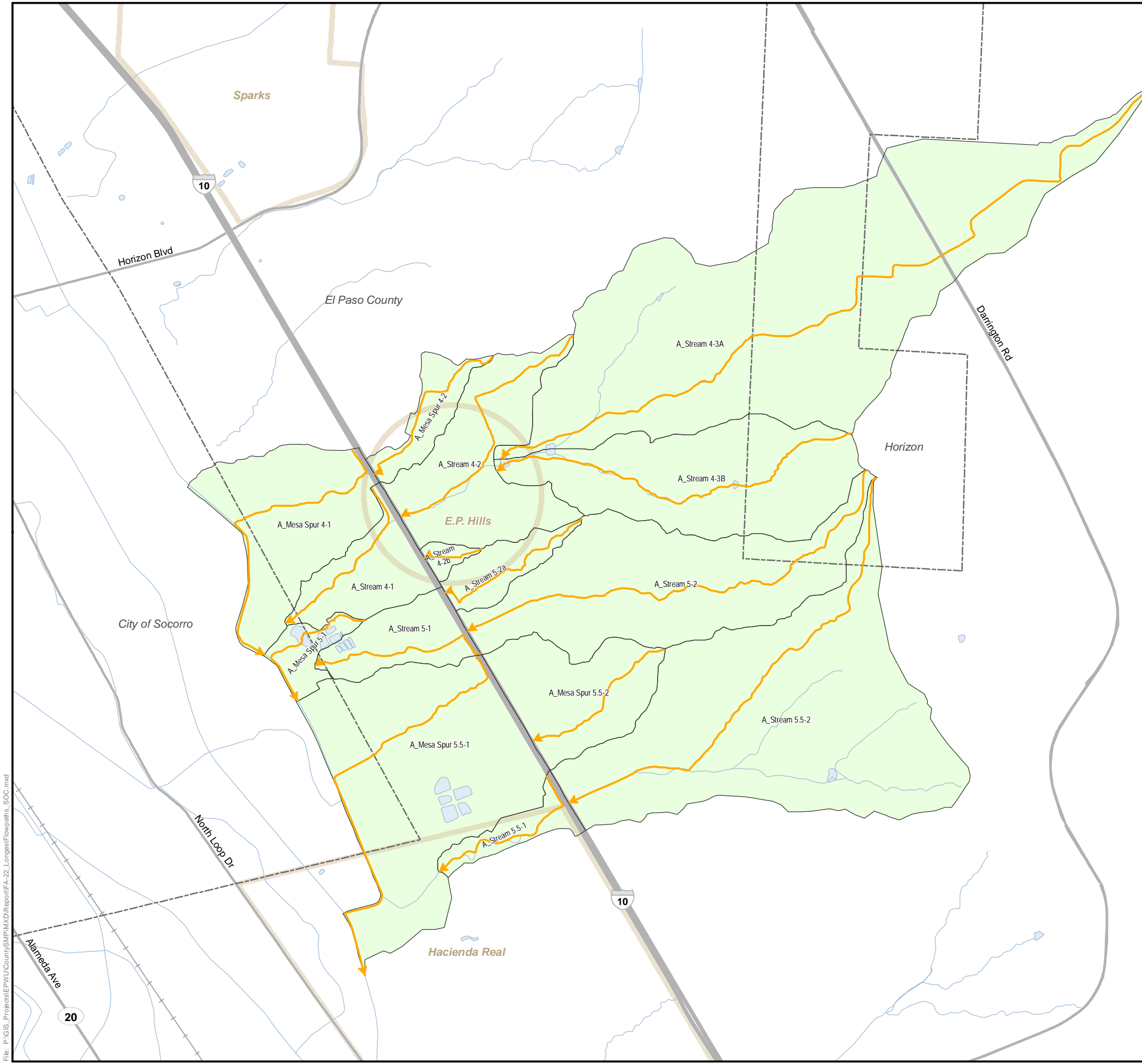

- Legend**
- Longest Flowpath
 - Watershed
 - Major Road
 - Railroad
 - Streamline
 - Water Body
 - Corporate Boundary
 - Designated Place

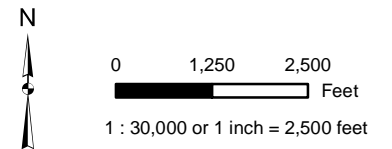

**Longest Flowpaths
Socorro Study Area**
El Paso County
Stormwater Master Plan

August 2010 Figure A-22



File: P:\GIS_Projects\EP\CountySMP\MXD\Report\FA-22_LongestFlowpaths_SOC.mxd

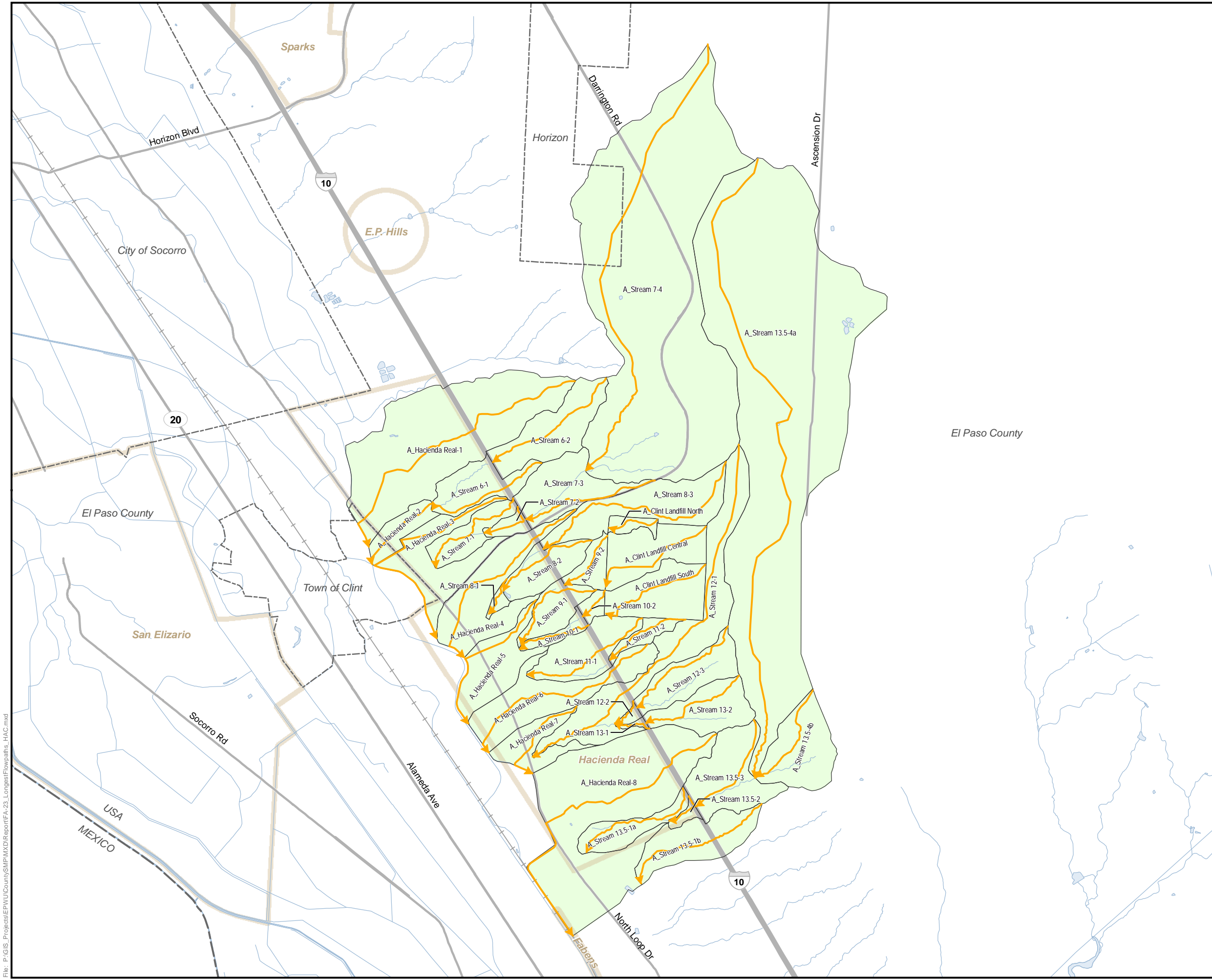

- Legend**
- Longest Flowpath
 - Watershed
 - Major Road
 - Railroad
 - Streamline
 - Water Body
 - State Boundary
 - Corporate Boundary
 - Designated Place

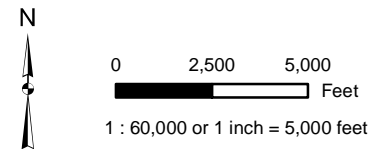

**Longest Flowpaths
Hacienda Real Study Area**
El Paso County
Stormwater Master Plan

August 2010 Figure A-23



File: P:\GIS_P\Projects\EP\U\County\SMP\MXD\Report\FA-23_LongestFlowpaths_HAC.mxd

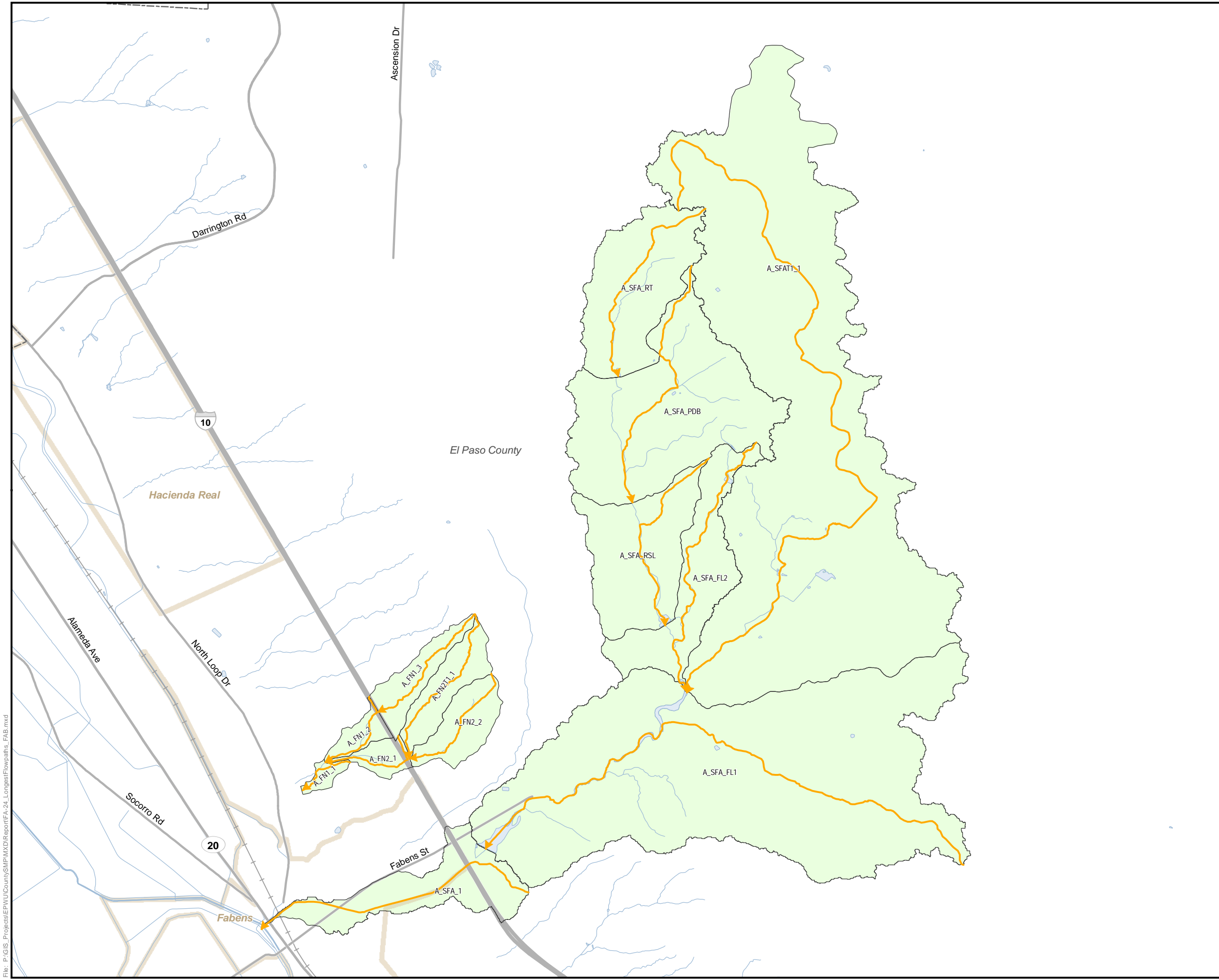

- Legend**
- Longest Flowpath
 - Watershed
 - Major Road
 - Railroad
 - Streamline
 - Water Body
 - Corporate Boundary
 - Designated Place

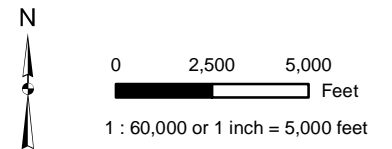

**Longest Flowpaths
Fabens Study Area**
El Paso County
Stormwater Master Plan

August 2010 Figure A-24



File: P:\GIS_Projects\EP\U\CountySMP\MXD\Report\FA-24_LongestFlowpaths_FAB.mxd

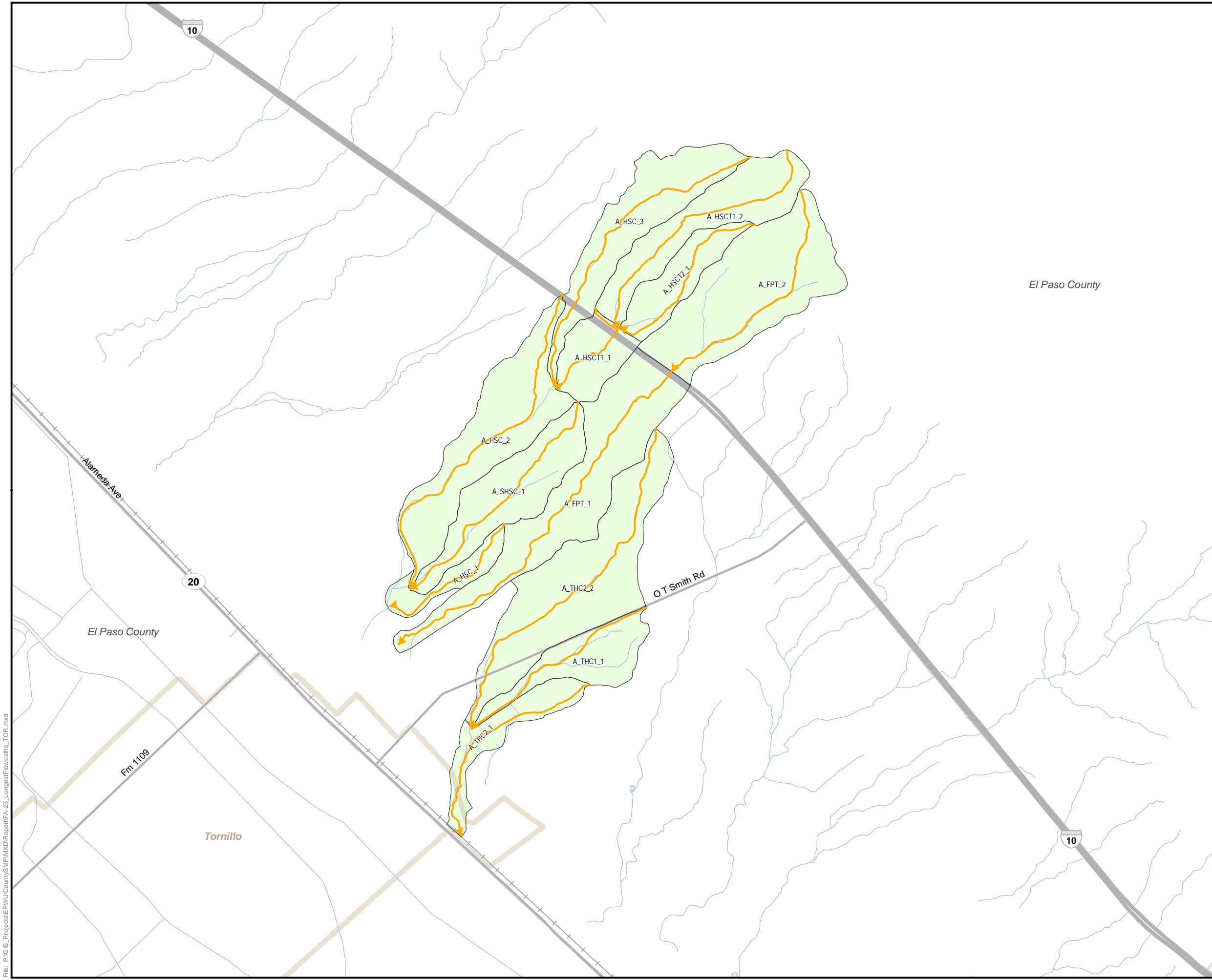

- Legend**
- Longest Flowpath
 - Watershed
 - Major Road
 - Railroad
 - Streamline
 - Water Body
 - Corporate Boundary
 - Designated Place

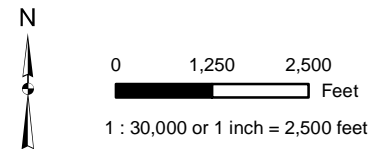







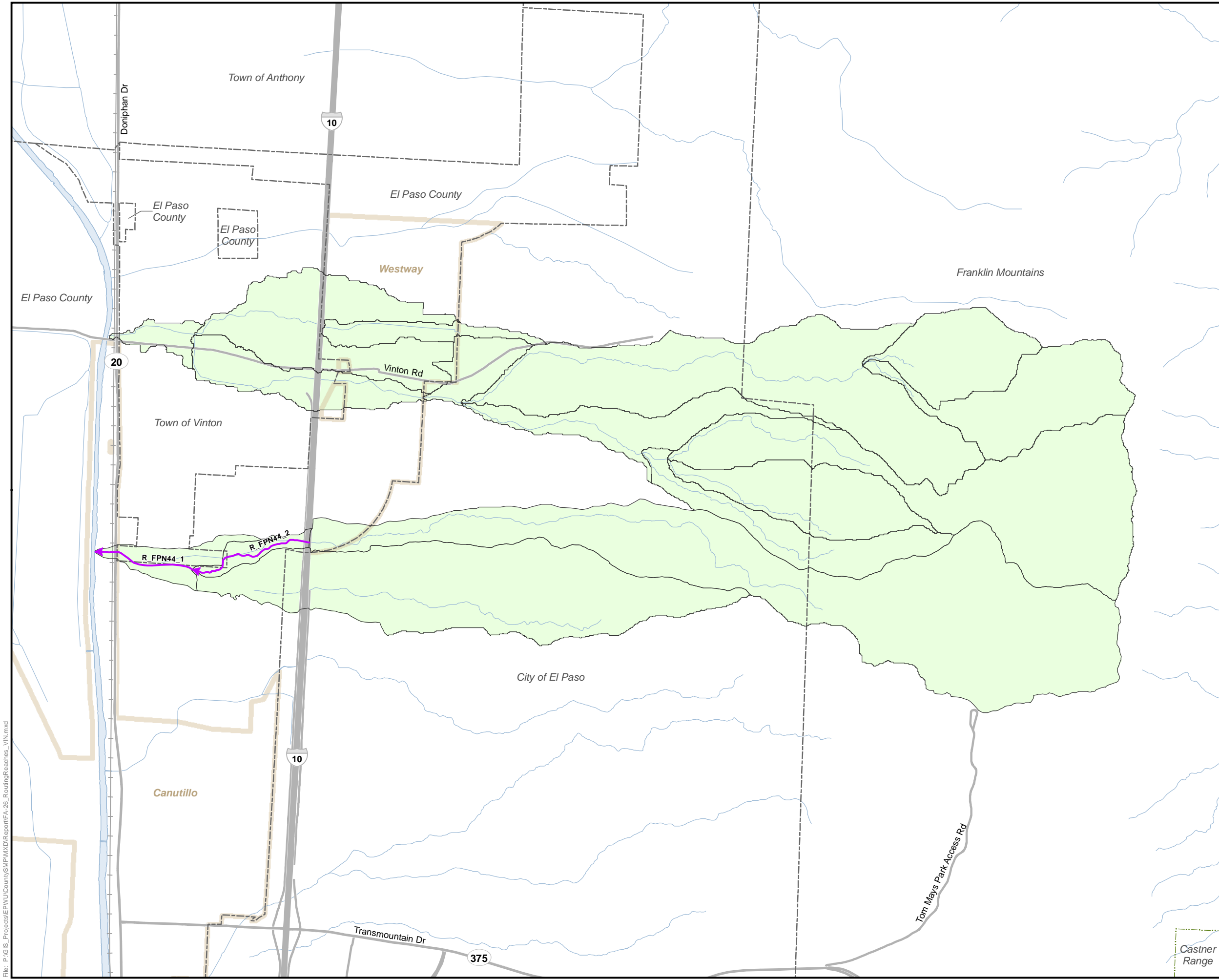

**Longest Flowpaths
Tornillo Study Area**
El Paso County
Stormwater Master Plan

August 2010 Figure A-25



File: P:\GIS_Projects\EP\U\County\SMP\MXD\Report\FA-25_LongestFlowpaths_TOR.mxd



- Legend**
-  Routing Reach
 -  Watershed
 -  Major Road
 -  Railroad
 -  Streamline
 -  Water Body
 -  Corporate Boundary
 -  Designated Place

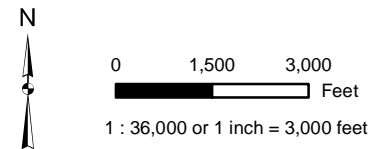







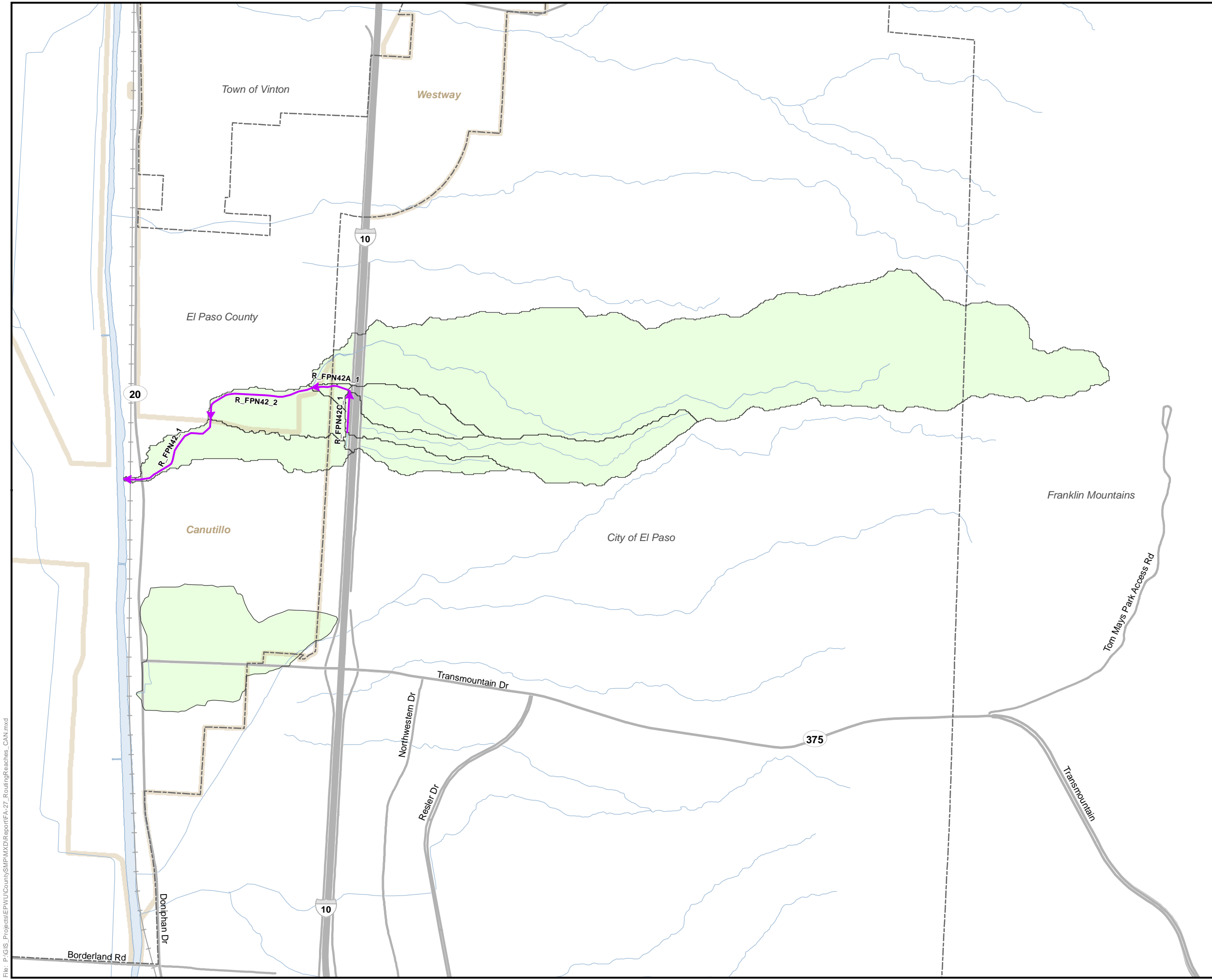

**Routing Reaches
Vinton Study Area**
El Paso County
Stormwater Master Plan

August 2010 Figure A-26



File: P:\GIS_Projects\EP\CountySMP\MXD\Report\FA-26_RoutingReaches_VIN.mxd



- Legend**
-  Routing Reach
 -  Watershed
 -  Major Road
 -  Railroad
 -  Streamline
 -  Water Body
 -  Corporate Boundary
 -  Designated Place

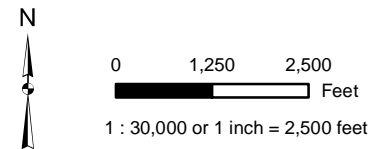

**Routing Reaches
Canutillo Study Area**
El Paso County
Stormwater Master Plan

August 2010 Figure A-27



File: P:\GIS_Projects\EP\U\County\SMP\MXD\Report\FA-27_RoutingReaches_CAN.mxd

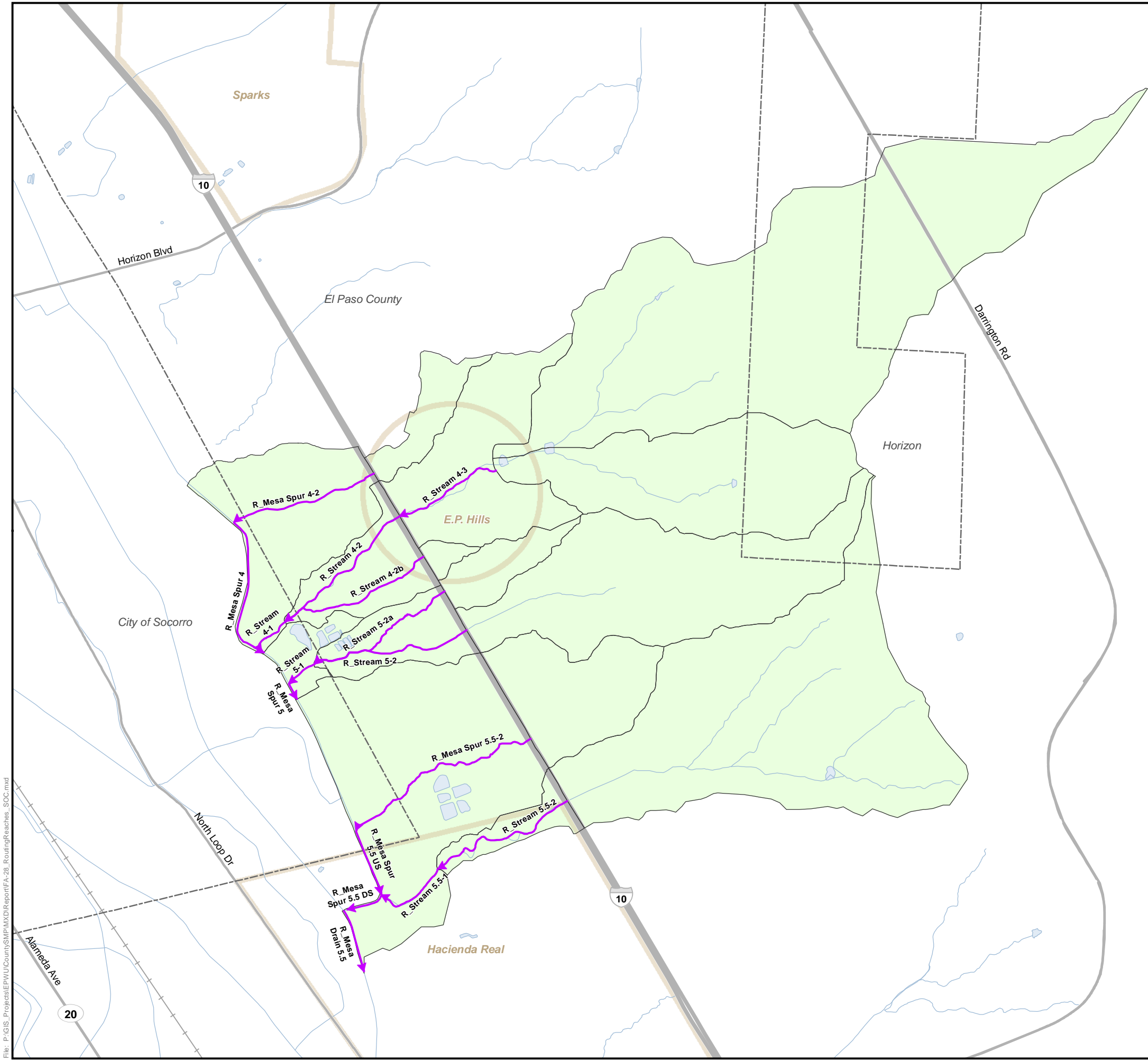

- Legend**
- Routing Reach
 - Watershed
 - Major Road
 - Railroad
 - Streamline
 - Water Body
 - Corporate Boundary
 - Designated Place

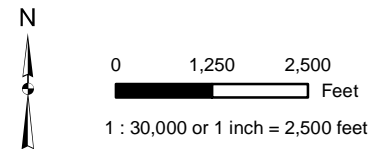

**Routing Reaches
Socorro Study Area**
El Paso County
Stormwater Master Plan

August 2010 Figure A-28



File: P:\GIS\Projects\EP\County\SMP\MXD\Report\FA-28_RoutingReaches_SOC.mxd

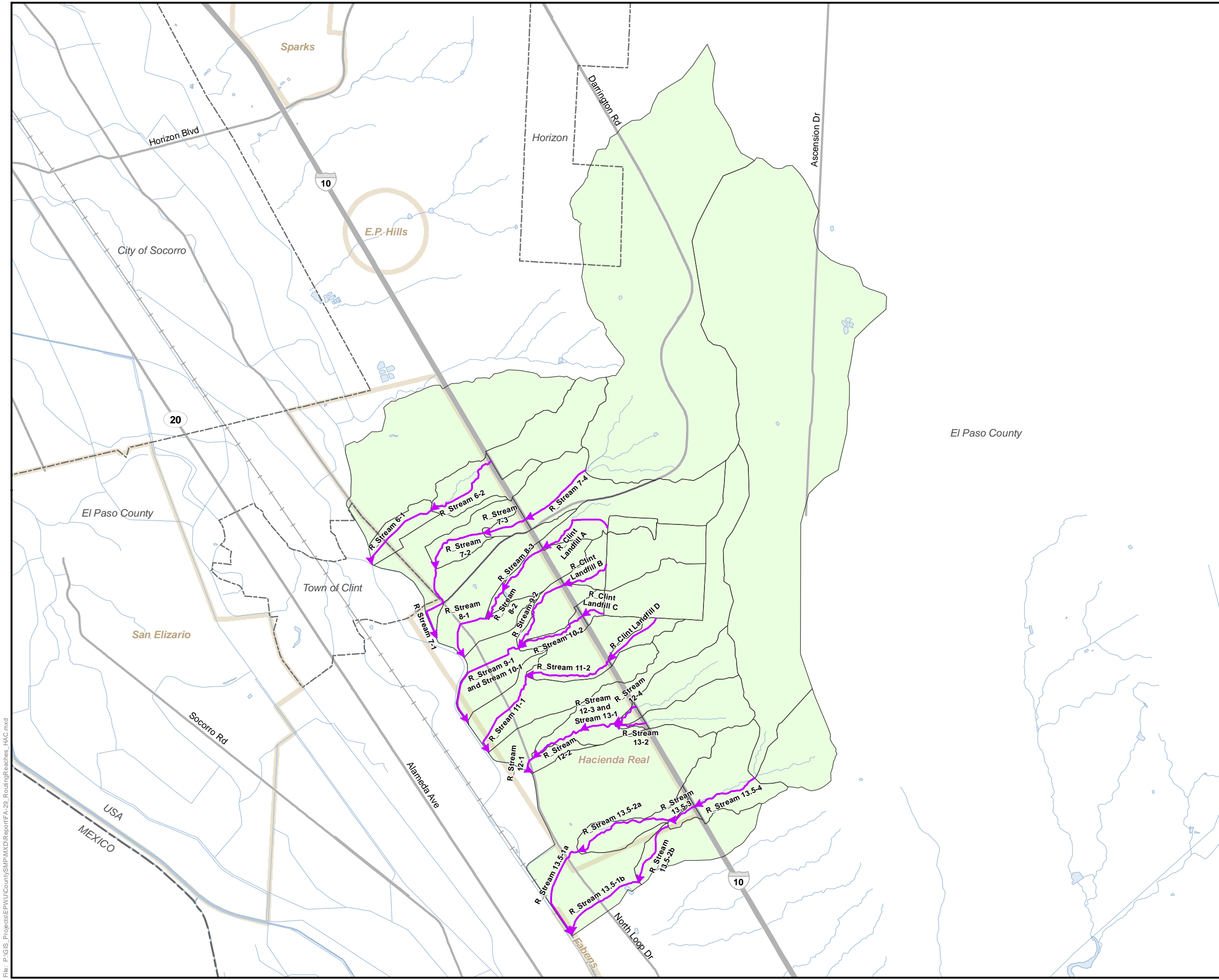

- Legend**
- Routing Reach
 - Watershed
 - Major Road
 - Railroad
 - Streamline
 - Water Body
 - State Boundary
 - Corporate Boundary
 - Designated Place

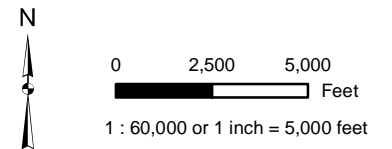







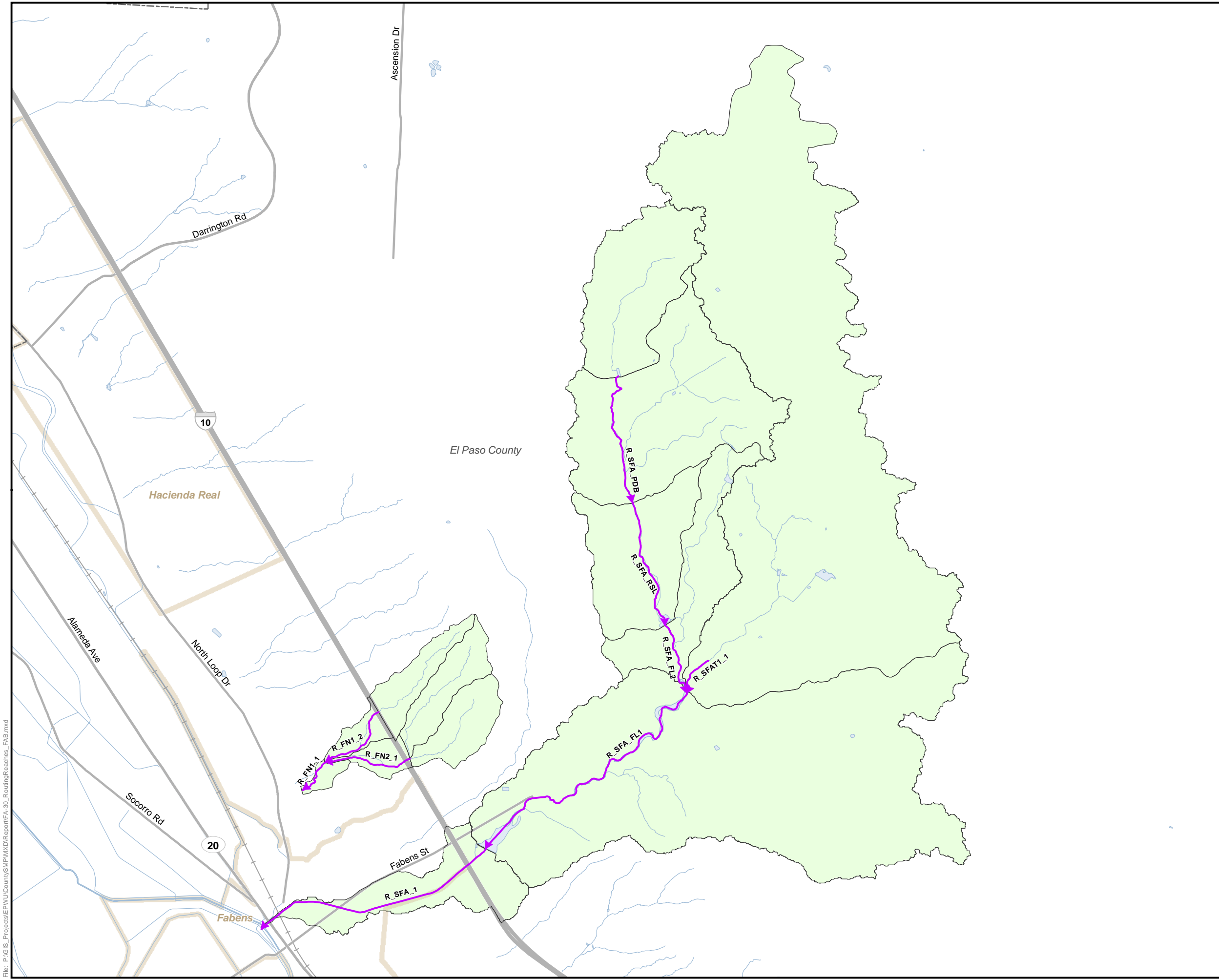

**Routing Reaches
Hacienda Real Study Area**
El Paso County
Stormwater Master Plan

August 2010 Figure A-29



File: P:\GIS_Projects\EP\CountySMP\MXD\Report\FA-29_RoutingReaches_HAC.mxd



- Legend**
-  Routing Reach
 -  Watershed
 -  Major Road
 -  Railroad
 -  Streamline
 -  Water Body
 -  Corporate Boundary
 -  Designated Place

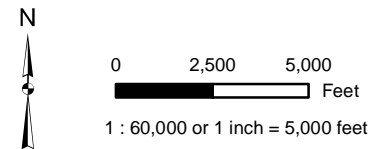

**Routing Reaches
Fabens Study Area**
El Paso County
Stormwater Master Plan

August 2010 Figure A-30



File: P:\GIS_Projects\EP\CountySMP\MXD\Report\FA-30_RoutingReaches_FAB.mxd

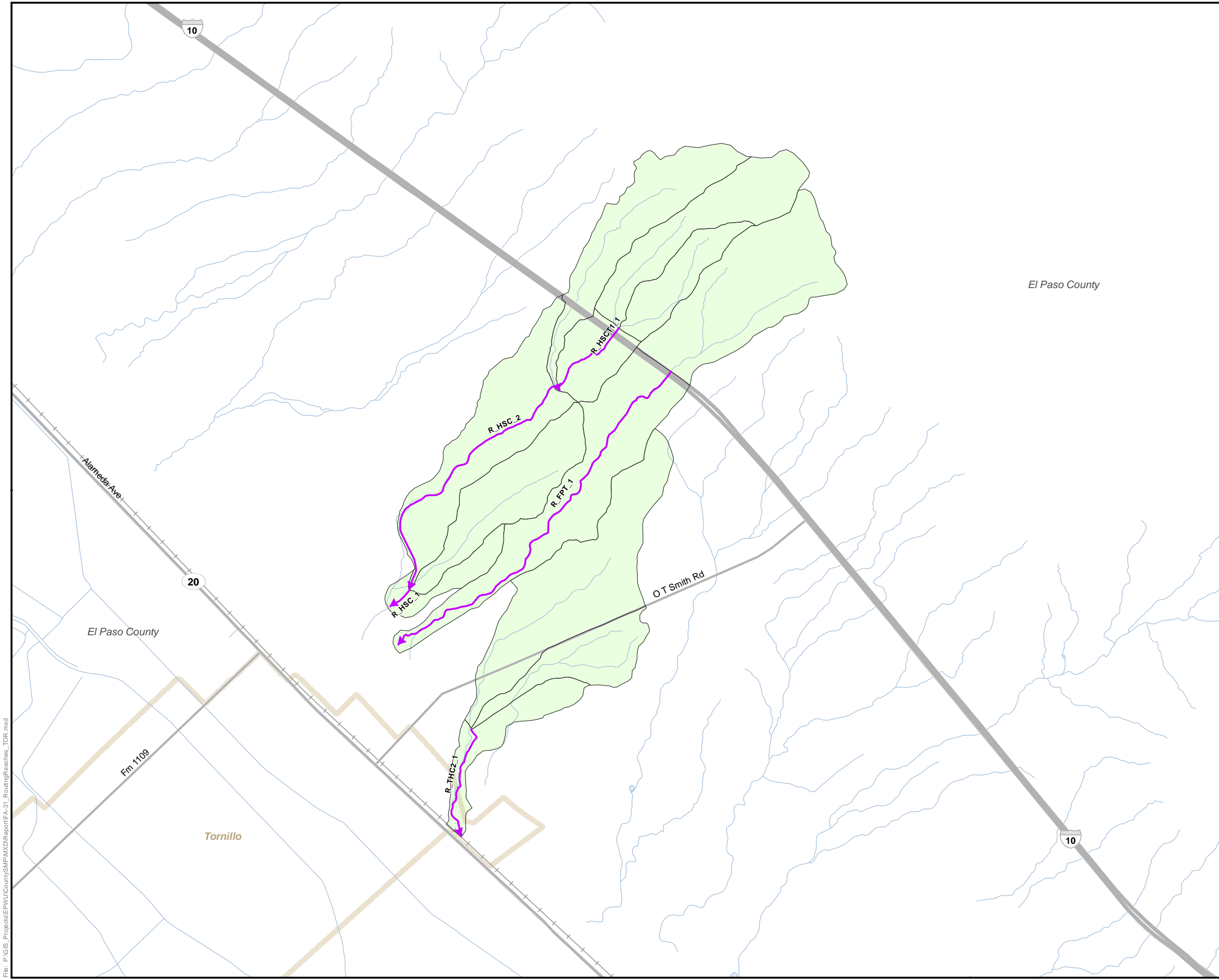

- Legend**
- Routing Reach
 - Watershed
 - Major Road
 - Railroad
 - Streamline
 - Water Body
 - Corporate Boundary
 - Designated Place

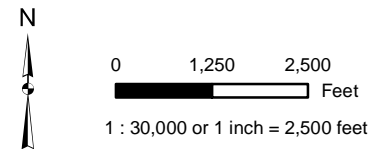

**Routing Reaches
Tornillo Study Area**
El Paso County
Stormwater Master Plan

August 2010 Figure A-31



File: P:\GIS_Projects\EP\U\County\SMP\MXD\Report\FA-31_RoutingReaches_TOR.mxd

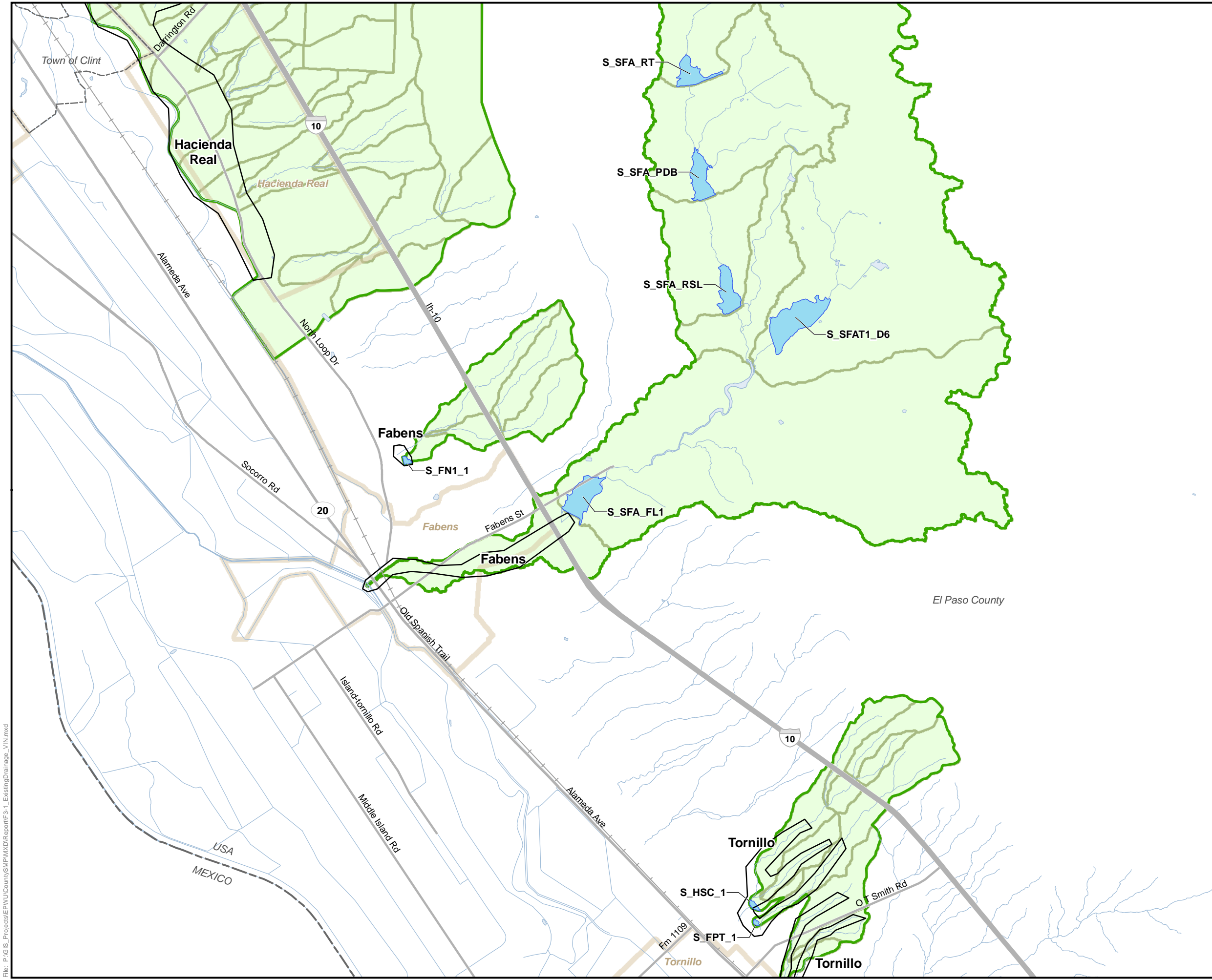

- Legend**
- Modeled Existing Detention Structure
 - Watershed
 - Watershed Area
 - Study Area
 - Major Road
 - Railroad
 - Streamline
 - Water Body
 - Corporate Boundary
 - Designated Place

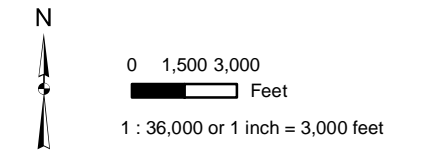

**Location Map
Modeled Existing
Detention Structures**
El Paso County
Stormwater Master Plan

August 2010 Figure A-32



File: P:\GIS_Projects\EP\U\County\SMP\MXD\Report\F3-1_ExistingDrainage_VIN.mxd

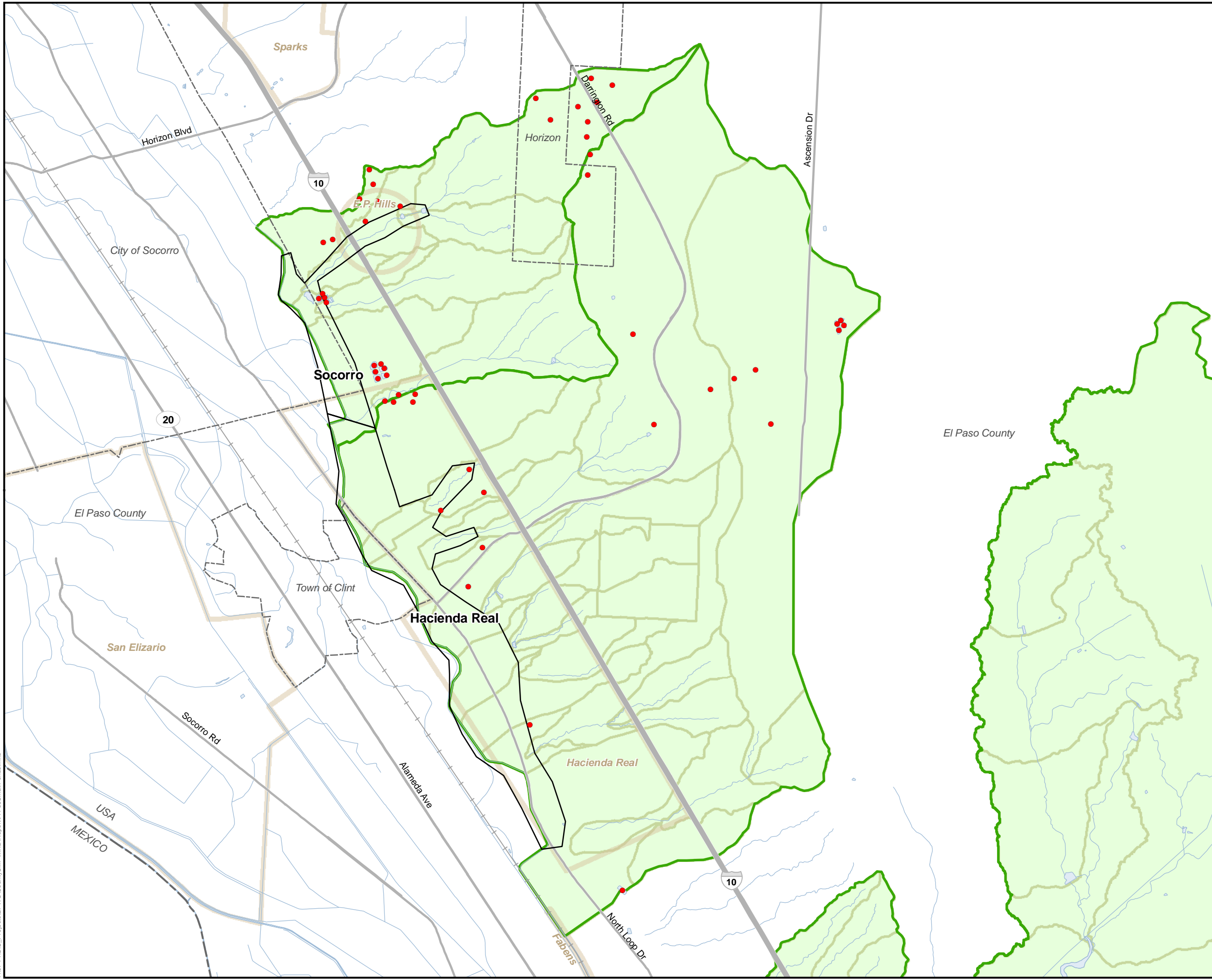

- Legend**
- Small Pond Location
 - ▭ Study Area
 - ▭ Watershed
 - ▭ Watershed Area
 - Major Road
 - +— Railroad
 - Streamline
 - ▭ Water Body
 - - - State Boundary
 - - - Corporate Boundary
 - ▭ Designated Place

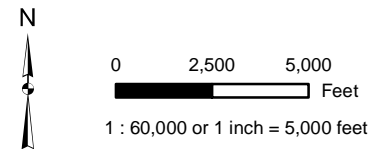

**Location Map
Small Ponds**
El Paso County
Stormwater Master Plan

August 2010 Figure A-33



File: P:\GIS_Projects\EP\U\County\SMP\MXD\Report\FA-33SmallPonds.mxd

Figure A-34. HEC-HMS Model Layout – Vinton Study Area

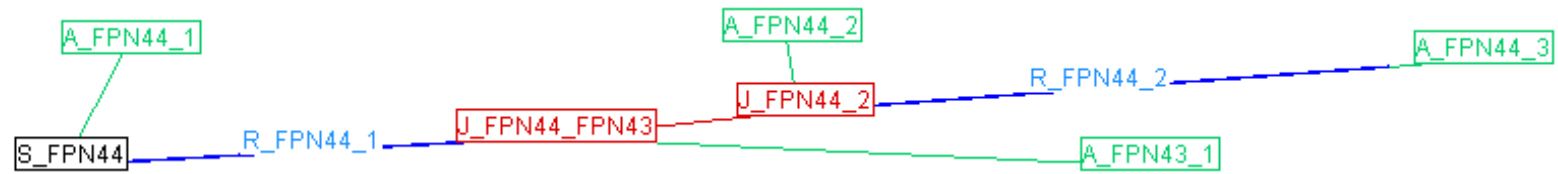

Figure A-35. HEC-HMS Model Layout – Canutillo Study Area

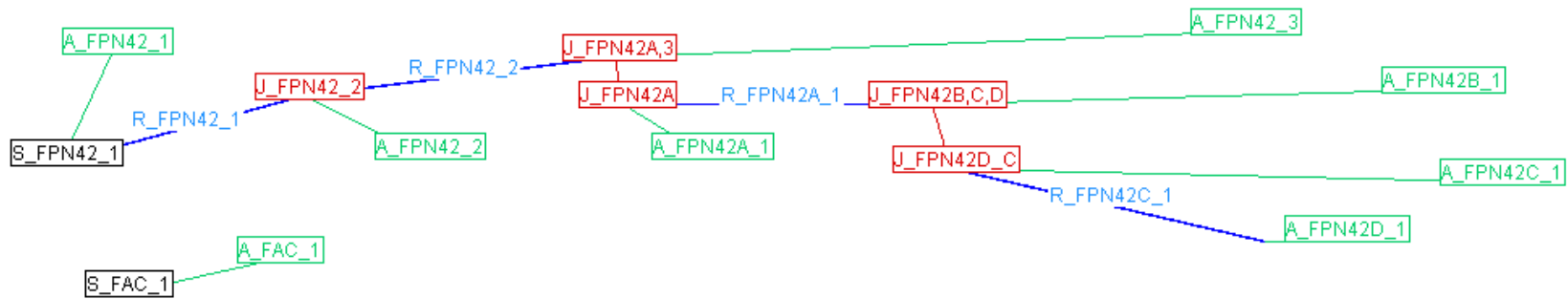

Figure A-36. HEC-HMS Model Layout – Socorro Study Area

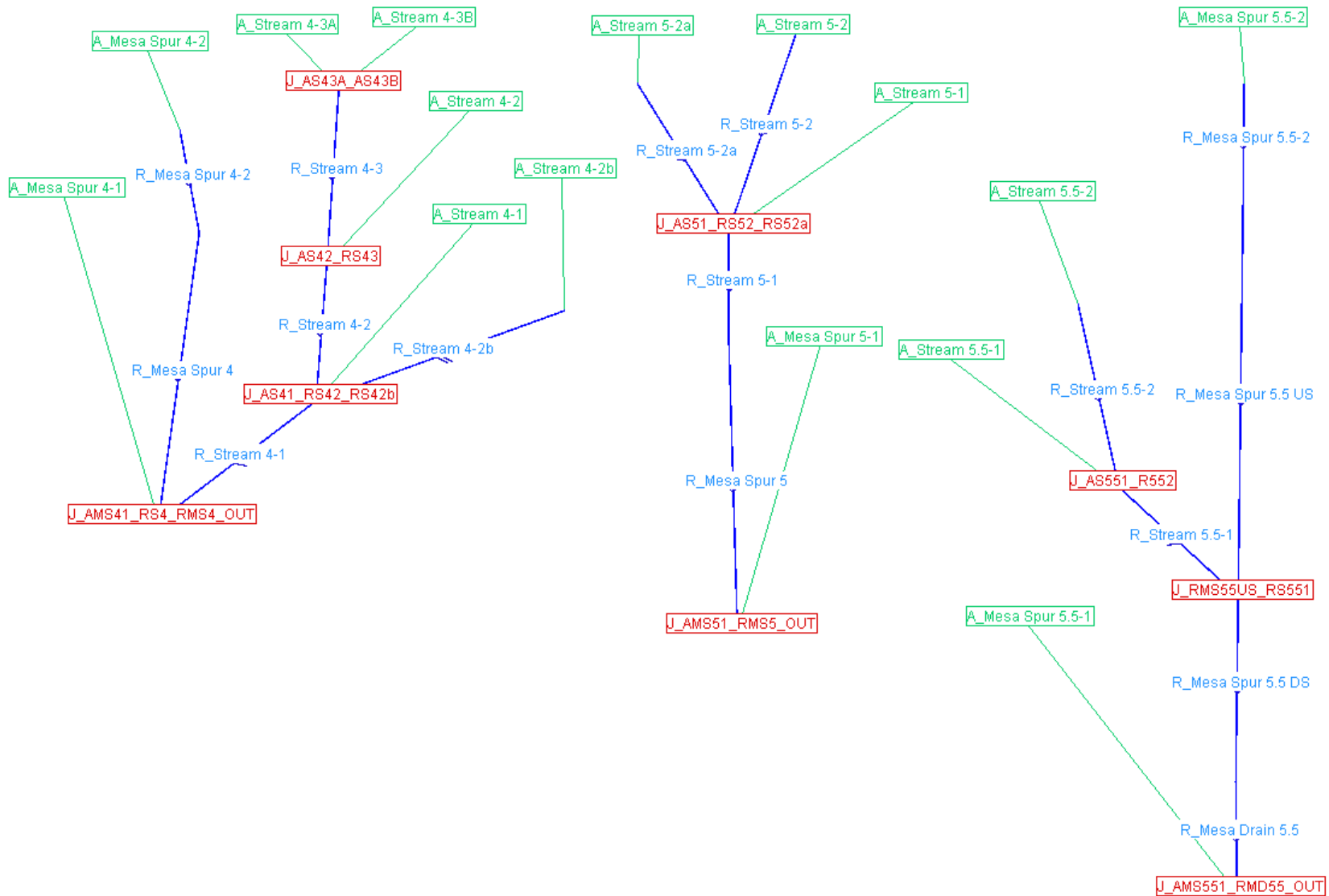

Figure A-37. HEC-HMS Model Layout – Hacienda Real Study Area

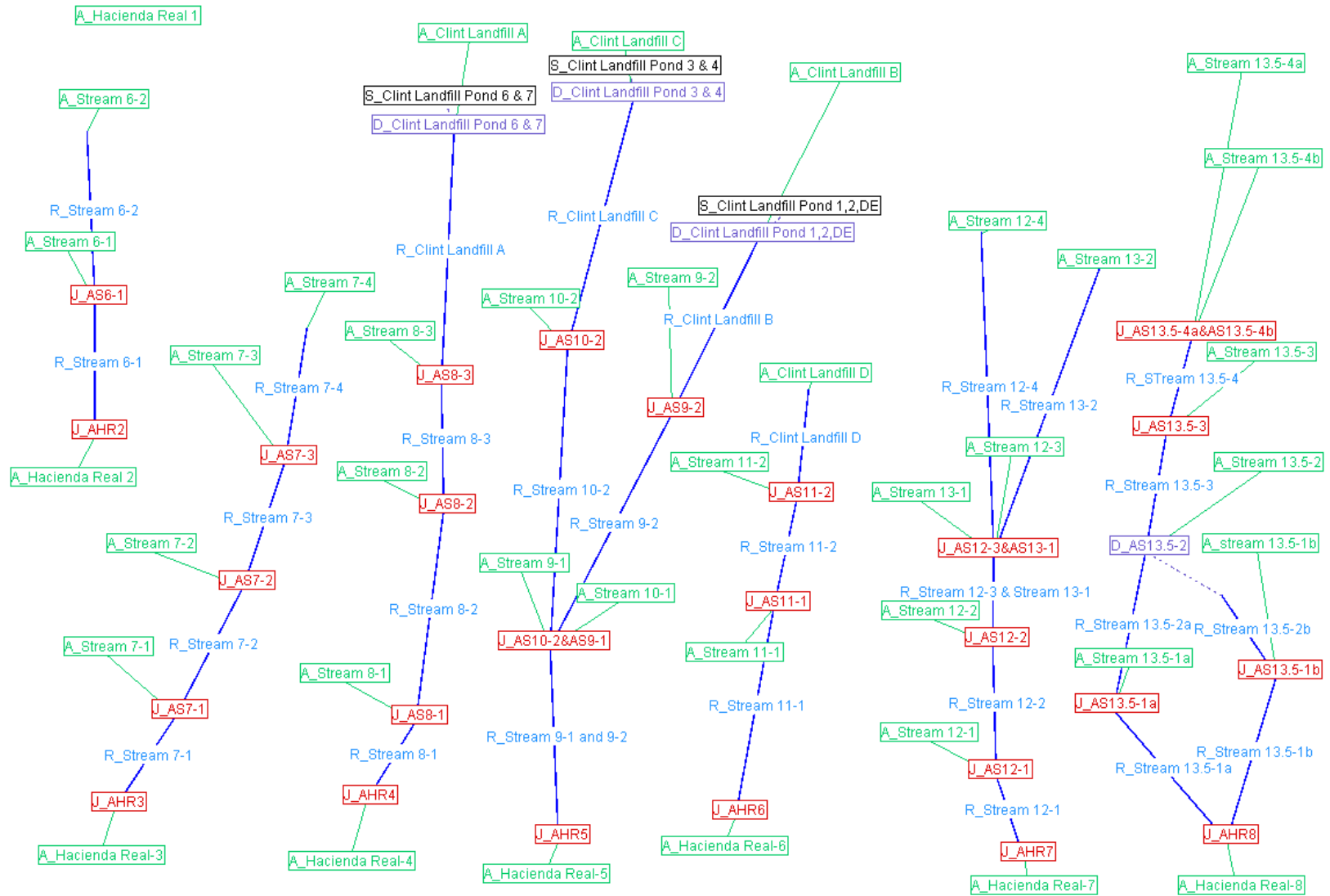

Figure A-38. HEC-HMS Model Layout – Fabens Study Area

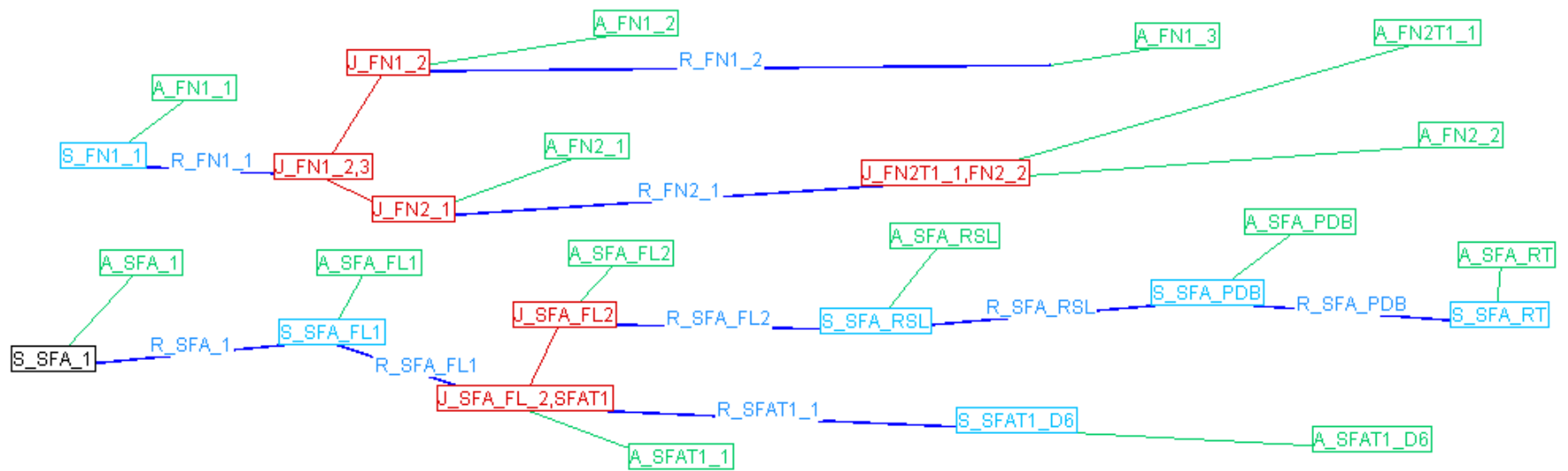
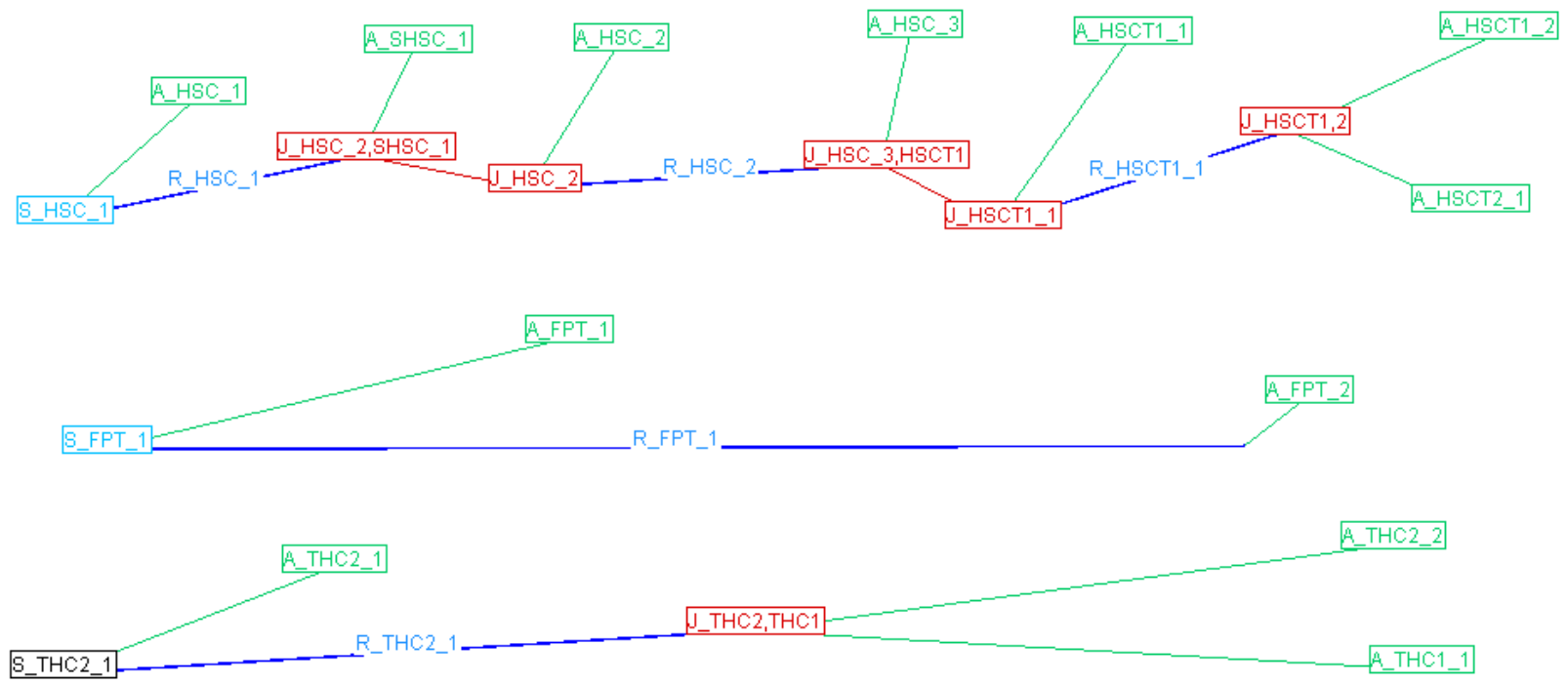

Figure A-39. HEC-HMS Model Layout – Tornillo Study Area



APPENDIX B
HYDRAULICS REPORT

This page was intentionally left blank.

TABLE OF CONTENTS

<u>Section</u>	<u>Page</u>
B.1.0 BACKGROUND	1
B.2.0 DATA SOURCES	3
B.3.0 CHANNEL ANALYSES.....	5
B.3.1 Method Overview.....	5
B.3.2 Channel Analysis - Vinton Study Area.....	5
B.3.3 Channel Analysis - Canutillo Study Area	5
B.3.4 Channel Analysis - Sparks Arroyo and Sub Basin A Study Area.....	5
B.3.5 Channel Analysis - Socorro Study Area	6
B.3.6 Channel Analysis - Hacienda Real Study Area	6
B.3.7 Channel Analysis - Fabens Study Area	6
B.3.8 Channel Analysis - Tornillo Study Area	6
B.4.0 CROSSING STRUCTURE ANALYSES.....	7
B.4.1 Method Overview.....	7
B.4.2 Crossing Structure Analysis - Vinton Study Area	7
B.4.3 Crossing Structure Analysis - Canutillo Study Area.....	7
B.4.4 Crossing Structure Analysis - Sparks Arroyo and Sub Basin A Study Area.....	8
B.4.5 Crossing Structure Analysis - Socorro Study Area	8
B.4.6 Crossing Structure Analysis - Hacienda Real Study Area	8
B.4.7 Crossing Structure Analysis - Fabens Study Area.....	8
B.4.8 Crossing Structure Analysis - Tornillo Study Area	8

LIST OF TABLES

Table B-1 Data Sources Used in Hydraulic Analysis.....	11
Table B-2 Channel Capacity Summary - Vinton Study Area	12
Table B-3 Channel Capacity Summary - Canutillo Study Area	13
Table B-4 Channel Capacity Summary - Sparks Arroyo and Sub Basin A Study Area	13
Table B-5 Channel Capacity Summary - Socorro Study Area.....	13
Table B-6 Channel Capacity Summary - Hacienda Real Study Area	14
Table B-7 Channel Capacity Summary - Fabens Study Area	14
Table B-8 Channel Capacity Summary - Tornillo Study Area.....	15
Table B-9 Culvert Capacity Summary - Vinton Study Area	16
Table B-10 Culvert Capacity Summary - Canutillo Study Area	17
Table B-11 Culvert Capacity Summary - Socorro Study Area.....	17
Table B-12 Culvert Capacity Summary - Hacienda Real Study Area	18
Table B-13 Culvert Capacity Summary - Fabens Study Area	19
Table B-14 Culvert Capacity Summary - Tornillo Study Area.....	19

LIST OF FIGURES

Figure B-1	Master Plan Study Areas	23
Figure B-2	Channel and Crossing Capacities - Vinton Study Area.....	24
Figure B-3	Channel and Crossing Capacities - Canutillo Study Area	25
Figure B-4	Channel and Crossing Capacities - Sparks Arroyo and Sub Basin A Study Area	26
Figure B-5	Channel and Crossing Capacities - Socorro Study Area	27
Figure B-6	Channel and Crossing Capacities - Hacienda Real Study Area	28
Figure B-7	Channel and Crossing Capacities - Fabens Study Area	29
Figure B-8	Channel and Crossing Capacities - Tornillo Study Area	30

B.1.0 BACKGROUND

A hydraulic analysis was performed for the study areas identified in *The Study of Rural Homesites Deemed at Risk of Flooding by the 100-Year Flood* (El Paso County, 2007) in order to identify drainage structures with capacity issues. The hydraulic efficiency of the structures in the El Paso County Study Areas was analyzed as follows:

- Normal depth calculations were performed along all study reaches to estimate channel capacity.
- CulvertMaster calculations were performed at channel crossings to estimate crossing capacity.
- Previous Federal Emergency Management Agency (FEMA) Hydrologic Engineering Center-River Analysis System (HEC-RAS) models listed below were reviewed to identify potential capacity issues.
 - Flow Path Number 42 - Canutillo Study Area
 - San Felipe Arroyo - Fabens Study Area
- Other features exhibiting poor performance were identified through site evaluation and County input.

This Appendix will present the basic methodologies associated with the calculations performed as part of the hydraulic evaluation process. An overview of the El Paso County Stormwater Master Plan (SMP) (hereafter referred to as County SMP) Study Areas is provided on Figure B-1.

This page was intentionally left blank.

B.2.0 DATA SOURCES

Table B-1 lists the sources used in the hydraulic analysis, as well as the specific calculation(s) each source was used for.

This page was intentionally left blank.

B.3.0 CHANNEL ANALYSES

B.3.1 Method Overview

As part of the hydraulic study, channel capacities were analyzed for cross-sections located along constructed study channels using Manning's Normal Depth assumption. In general, natural arroyo capacities were not estimated. Channel geometry was estimated from a variety of sources including site visit estimates, structure survey conducted as part of this project, 2008 Orthophotography (El Paso County, 2008), and 2004 Topography (Texas Department of Transportation [TxDOT], 2004). Cross-sections were analyzed near all crossing structures in order to estimate the channel capacity for the study channel. Capacity estimates were performed using Bentley FlowMaster, or an equivalent Normal Depth Method.

ArcView shapefiles were digitized to show the approximate cross-section locations corresponding to the capacities estimated for each of the regions studied.

B.3.2 Channel Analysis - Vinton Study Area

Channel flow capacities were calculated for Flow Path Number 44 within the Vinton Study Area as described above. Channel top width, bottom width, and depth were determined using 2004 Topography (TxDOT, 2004), survey data where available, and 2008 Orthophotography (El Paso County, 2008). Channel slopes were estimated using the average channel slope within the region where the channel geometry is consistent. Flow Path Number 45 and Flow Path No. 45A used the results that were determined during the analysis for the City of El Paso SMP (hereafter referred to as the City SMP). Results are provided in Table B-2 and Figure B-2 located at the end of this Appendix.

B.3.3 Channel Analysis - Canutillo Study Area

Channel flow capacities were calculated for First Avenue Channel and Flow Path Number 42 within the Canutillo Study Area as described above. First Avenue Channel's top width, bottom width, and depth were determined by survey data received for this project and verified using 2008 Orthophotography (El Paso County, 2008). Channel slope was estimated using the average channel slope between surveyed crossing structures. Flow Path Number 42 utilized a previous FEMA HEC-RAS model, completed during the 2005 FEMA update of the Flood Insurance Rate Maps (FIRMs) and Flood Insurance Study (FIS) for El Paso County. The model's span is from Interstate Highway 10 (IH-10) to Flow Path Number 42's outlet at the Rio Grande. Results are provided in Table B-3 and Figure B-3 located at the end of this Appendix.

B.3.4 Channel Analysis - Sparks Arroyo and Sub Basin A Study Area

The channel flow capacity was calculated for of the Sparks Arroyo within the Sparks Arroyo and Sub Basin A Study Area as described above. Channel top width, bottom width, and depth were estimated using 2004 Topography (TxDOT, 2004) and 2008 Orthophotography (El Paso County, 2008). Channel slope was estimated using 2004

Topography (TxDOT, 2004). Results are provided in Table B-4 and Figure B-4 located at the end of this Appendix.

B.3.5 Channel Analysis - Socorro Study Area

Channel flow capacities were calculated for the Mesa Spur Drain within the Socorro Study Area as described above. Channel top width, bottom width, and depth were measured during initial site visits and verified using 2008 Orthophotography (El Paso County, 2008). Channel slope was estimated using the average channel slope between surveyed crossing structures. Results are provided in Table B-5 and Figure B-5 located at the end of this Appendix.

B.3.6 Channel Analysis - Hacienda Real Study Area

Channel flow capacities were calculated for the Mesa Drain within the Hacienda Real Study Area as described above. Channel top width, bottom width, and depth were measured during initial site visits and verified using 2008 Orthophotography (El Paso County, 2008). Channel slope was estimated using the average channel slope between surveyed crossing structures. Results are provided in Table B-6 and Figure B-6 located at the end of this Appendix.

B.3.7 Channel Analysis - Fabens Study Area

Channel flow capacities were calculated for the Fabens North 1 and Fabens North 2 Channels within the Fabens Study Area as described above. Channel top width, bottom width, and depth were determined using 2004 Topography (TxDOT, 2004) and 2008 Orthophotography (El Paso County, 2008) for Fabens North 1 and Fabens North 2. Channel slope was estimated using the average channel slope between the confluence and either the outlet structure or crossing structure. San Felipe Arroyo utilized the FEMA HEC-RAS model, completed during the 2005 FEMA update of the FIRMs and FIS for El Paso County. The model span is from IH-10 to the channel outlet at the River Drain Canal. Results are provided in Table B-7 and Figure B-7 located at the end of this Appendix.

B.3.8 Channel Analysis - Tornillo Study Area

Channel flow capacities were calculated for the five channels located within the Tornillo Study Area as described above. Channel top width, bottom width, and depth were determined using 2004 Topography (TxDOT, 2004) and 2008 Orthophotography (El Paso County, 2008). Channel slopes were estimated using the average channel slope within the region where the channel geometry is consistent. Results are provided in Table B-8 and Figure B-8 located at the end of this Appendix.

B.4.0 CROSSING STRUCTURE ANALYSES

B.4.1 Method Overview

Crossing capacities were estimated using CulvertMaster and compared to channel capacities in order to identify potentially undersized crossings. Culvert geometry was obtained from a variety of sources including survey performed as part of this study and IH-10 crossing as-builts (TxDOT, 1957). In order to ascertain the effect of tailwater on the culverts included in this study, a downstream channel cross-section was entered for each culvert into CulvertMaster. Clear span bridges were not typically analyzed because they do not constrict channel flow and would have approximately the same capacity as the channel itself.

CulvertMaster uses several parameters, including the upstream invert elevation, the downstream invert elevation, and slope to analyze a culvert. Survey data was used where available for upstream and downstream invert elevations as well as top of road elevations. Inverts for IH-10 crossings were taken directly from the IH-10 as-builts (TxDOT, 1957).

As mentioned above, a parameter that is used by CulvertMaster to calculate tailwater depth is the channel geometry downstream of the culvert. This geometry was typically estimated from the nearest downstream analyzed cross-section as described in Section B.3.0. The bottom of channel elevation was set to the downstream invert used in the culvert analysis.

As with the channel analysis described previously, ArcView shapefiles were digitized to show the approximate crossing locations. For the crossings analyzed, the nearest downstream Hydrologic Engineering Center-Hydrologic Modeling System (HEC-HMS) flow node was identified for crossings on modeled channels and a comparison was performed between the 100-year frequency flow and the crossing capacity. If not on a modeled channel, the nearest analyzed channel cross-section was identified and compared to the crossing capacity to determine if the crossing was insufficiently sized to handle bank full channel flow.

B.4.2 Crossing Structure Analysis - Vinton Study Area

Crossing capacities were estimated for Flow Path Number 44 in the Vinton Study Area as described above. Flow Path Number 45 and Flow Path Number 45A crossings were analyzed during the City SMP and the results were incorporated into this study. Results are provided in Table B-9 and Figure B-2 located at the end of this Appendix.

B.4.3 Crossing Structure Analysis - Canutillo Study Area

Crossing capacities were estimated for First Avenue Channel in the Canutillo Study Area as described above. It was not necessary to analyze the crossing at West Avenue and First Avenue Channel, as it was identified as being visibly undersized during field reconnaissance. The crossing capacities along Flow Path Number 42 were estimates in the HEC-RAS model completed for the 2005 FEMA update of the FIRMs and FIS for

El Paso County. Results are provided in Table B-10 and Figure B-3 located at the end of this Appendix.

B.4.4 Crossing Structure Analysis - Sparks Arroyo and Sub Basin A Study Area

Existing crossing capacities were not estimated for the Sparks Arroyo and Sub Basin A Study Area as part of this SMP.

B.4.5 Crossing Structure Analysis - Socorro Study Area

Crossing capacities were estimated for the Socorro Study Area as described above. Results are provided in Table B-11 and Figure B-5 located at the end of this Appendix.

B.4.6 Crossing Structure Analysis - Hacienda Real Study Area

Crossing capacities were estimated for the Hacienda Real Study Area as described above. Results are provided in Table B-12 and Figure B-6 located at the end of this Appendix.

B.4.7 Crossing Structure Analysis - Fabens Study Area

Crossing capacities were estimated for the Fabens Study Area using the HEC-RAS model completed for the 2005 FEMA update of the FIRMs and FIS for El Paso County. Results are provided in Table B-13 and Figure B-7 located at the end of this Appendix.

B.4.8 Crossing Structure Analysis - Tornillo Study Area

Crossing capacities were estimated for the Tornillo Study Area as described above. Results are provided in Table B-14 and Figure B-8 located at the end of this Appendix.

TABLES

This page was intentionally left blank.

Table B-1. Data Sources Used in Hydraulic Analysis

Source	Used For
Bentley, CulvertMaster, 2005.	Conduit Analysis
Bentley, FlowMaster, 2005.	Channel Analysis
El Paso County, 2008. Orthophotography.	Crossing Analysis Channel Analysis
ESRI ArcView, Version 9.2 (2006) and Version 9.3.1 (2009).	Crossing Analysis Channel Analysis
Federal Emergency Management Agency (FEMA), 2005. Updated Flood Insurance Rate Maps (FIRMs) and Flood Insurance Study (FIS).	Channel Analysis
Texas Department of Transportation (TxDOT), 1957. Plans for Proposed Highway Improvement, IH-10 From FM 659 to a Point 2 Miles NE of Fabens. As-Builts.	Crossing Analysis
TxDOT, El Paso Office, 2004. Topography.	Crossing Analysis Channel Analysis

Table B-2. Channel Capacity Summary - Vinton Study Area

Channel	Bottom Width (ft)	Side Slopes (H:V)	Depth (ft)	Manning's n	Cross-Section Capacity (cfs)	Cross-Section Location	HMS Node ID	100-Year Flow (cfs)
Flow Path Number 44	11	3:1	8.5	0.032	2,169	360' Upstream of Doniphan Drive	S_FPN44	2,169
Flow Path Number 44	6	4:1	6.5	0.03	1,175	1,080' Downstream of Confluence of Flow Path Number 43	R_FPN44_1	2,146
Flow Path Number 44	67	2:1	1	0.03	525	480' Downstream of IH-10	R_FPN44_2	1,280
Flow Path Number 45 (Vinton)	Irregular Geometry			0.03	511	10,800' Upstream of Tom Mays Drive	N/A	511
Flow Path Number 45 (Vinton)	Irregular Geometry			0.031	2,909	4,625' Upstream of Tom Mays Drive	N/A	2,909
Flow Path Number 45 (Vinton)	Irregular Geometry			0.035	1,000	466' Downstream of Tom Mays Drive	N/A	2,909
Flow Path Number 45 (Vinton)	Irregular Geometry			0.035	6,070	340' Downstream of IH-10	N/A	6,070
Flow Path Number 45 (Vinton)	Irregular Geometry			0.03	2,910	250' Downstream of IH-10 Southbound On-Ramp	N/A	6,070
Flow Path Number 45 (Vinton)	Irregular Geometry			0.035	1,020	250' Downstream of Kiely Road	N/A	6,201
Flow Path Number 45 (Vinton)	Irregular Geometry			0.031	6,201	290' Downstream of AP Ramirez Street	N/A	6,201
Flow Path Number 45 (Vinton)	Irregular Geometry			0.03	660	Channel Downstream End	N/A	6,201
Flow Path Number 45A	Irregular Geometry			0.015	120	700' Upstream of De Alva Drive	N/A	189
Flow Path Number 45A	Irregular Geometry			0.03	1,050	550' Downstream of IH-10	N/A	1,050
Flow Path Number 45A	Irregular Geometry			0.03	550	200' Downstream of Lovena Way Road	N/A	1,050
Flow Path Number 45A	Irregular Geometry			0.032	630	535' Downstream of Lovena Way Road	N/A	1,050
Flow Path Number 45A	Irregular Geometry			0.032	1,050	200' Upstream of Kiely Road	N/A	1,050
Flow Path Number 45A	Irregular Geometry			0.032	1,050	290' Upstream of Confluence with Flow Path Number 45	N/A	1,050

Table B-3. Channel Capacity Summary - Canutillo Study Area

Channel	Bottom Width (ft)	Side Slopes (H:V)	Depth (ft)	Manning's n	Cross-Section Capacity (cfs)	Cross-Section Location	HMS Node ID	100-Year Flow (cfs)
First Avenue Channel	4	1:1	3	0.013	137	Upstream of West Avenue	A_FAC_1	533
Flow Path Number 42	Irregular Geometry			0.05	1,527	Upstream of Los Mochis Road	J_FPN42A,3	1,527
Flow Path Number 42	Irregular Geometry			0.05	1,537	530' Upstream of Doniphan Drive	J_FPN42_2	1,578
Flow Path Number 42	Irregular Geometry			0.05	571	Upstream of Doniphan Drive	J_FPN42_2	1,578

Table B-4. Channel Capacity Summary - Sparks Arroyo and Sub Basin A Study Area

Channel	Bottom Width (ft)	Side Slopes (H:V)	Depth (ft)	Manning's n	Cross-Section Capacity (cfs)	Cross-Section Location	HMS Node ID	100-Year Flow (cfs)
Sparks Arroyo	25	3	5	0.03	2,650	Sparks	N/A	N/A

Table B-5. Channel Capacity Summary - Socorro Study Area

Channel	Bottom Width (ft)	Side Slopes (H:V)	Depth (ft)	Manning's n	Cross-Section Capacity (cfs)	Cross-Section Location	HMS Node ID	100-Year Flow (cfs)
Mesa Spur Drain	10	1	10	0.05	335	Upstream of Carr Rd	N/A	N/A
Mesa Spur Drain	10	1	10	0.05	330	Upstream of Coker Rd	N/A	N/A
Mesa Spur Drain	10	1.5	8.5	0.05	275	Upstream of Anderson Rd	N/A	N/A
Mesa Spur Drain	12	1.25	10	0.05	480	Upstream of Mesa Drain	N/A	N/A

Table B-6. Channel Capacity Summary - Hacienda Real Study Area

Channel	Bottom Width (ft)	Side Slopes (H:V)	Depth (ft)	Manning's n	Cross-Section Capacity (cfs)	Cross-Section Location	HMS Node ID	100-Year Flow (cfs)
Mesa Drain	12	1.5	10	0.05	500	Upstream of Young John	N/A	N/A
Mesa Drain	16	1	9	0.05	470	Upstream of Pickard	N/A	N/A
Mesa Drain	12	1.5	9	0.05	320	Upstream of Northloop	N/A	N/A
Mesa Drain	17	1	9	0.05	870	Upstream of FM 1110 (Clint Cut-Off)	N/A	N/A
Mesa Drain	15	1.5	12	0.05	970	Upstream of Salatral Lateral	N/A	N/A
Mesa Drain	11	1	11	0.05	230	Upstream of Fenter	N/A	N/A
Mesa Drain	11	1.5	10	0.05	670	1000' Upstream of Celum (Dirt Road Crossing)	N/A	N/A
Mesa Drain	12	1.5	10	0.05	590	Upstream of Celum	N/A	N/A

Table B-7. Channel Capacity Summary - Fabens Study Area

Channel	Bottom Width (ft)	Side Slopes (H:V)	Depth (ft)	Manning's n	Cross-Section Capacity (cfs)	Cross-Section Location	HMS Node ID	100-Year Flow (cfs)
Fabens North 1	25	4:1	3	0.03	201	1830' Upstream of Downstream End	J_FN1_2,3	201
Fabens North 1	59	15:1	1	0.031	74	1355' Downstream of I-10 Crossing	J_FN1_2	74
Fabens North 2	72	3:0.5	0.5	0.03	127	1050' Downstream of I-10 Crossing	J_FN2_1	127
San Felipe Arroyo	Irregular Geometry			0.03	629	Upstream of Citizen Transfer Road	R_SFA_1	629

Table B-8. Channel Capacity Summary - Tornillo Study Area

Channel	Bottom Width (ft)	Side Slopes (H:V)	Depth (ft)	Manning's n	Cross-Section Capacity (cfs)	Cross-Section Location	HMS Node ID	100-Year Flow (cfs)
High School Channel	13	21:1	1	0.033	283	440' Upstream of Downstream End	S_HSC_1	283
High School Channel	22	3:1	3	0.033	254	1533' Upstream of Confluence of South High School Channel	J_HSC_2	254
High School Channel	82	5:1	1	0.03	223	3165' Downstream of Confluence of High School Channel Trib 1	R_HSC_2	223
South High School Channel	21	4:1	2	0.03	25	3000' Upstream of Confluence with High School Channel	A_SHSC_1	25
Flow Path T	46	1:1	1	0.03	232	5100' Upstream of Downstream end	S_FPT_1	232
Flow Path T	58	10:1	2	0.03	143	2670' Downstream of IH-10	R_FPT_1	143
Tornillo Handle Channel 1	32	4:1	4	0.03	17	810' Upstream of Confluence with Tornillo Handle Channel 2	A_THC1_1	17
Tornillo Handle Channel 1	23	14:1	1	0.03	17	2940' Upstream of Confluence with Tornillo Handle Channel 2	A_THC1_1	17
Tornillo Handle Channel 2	28	1:1	1	0.03	84	1160" Downstream of Big Master Street	S_THC2_1	84
Tornillo Handle Channel 2	13	4:1	2	0.03	53	Downstream of OT Smith Road	A_THC2_2	53
Tornillo Handle Channel 2	56	1:1	1	0.03	27	3300' Upstream of OT Smith Road	A_THC2_2	27

Table B-9. Culvert Capacity Summary - Vinton Study Area

Channel	Dimensions	Length (ft)	Velocity (ft/s)	Crossing Capacity (cfs)	Crossing Location	HMS Node ID	100-Year Flow (cfs)	Channel Capacity
Flow Path Number 44	1 - 16' x 5' CBC	70	27.11	800	Doniphan Drive	S_FPN44	2,169	2,169
Flow Path Number 45 (Vinton)	13 - 9' x 5' CBC	39	17	5,065	FP45 CV IH-10 Off-Ramp	NA	6,070	6,070
Flow Path Number 45 (Vinton)	Bridge	142	8	6,070	FP45 IH-10	NA	6,070	6,070
Flow Path Number 45 (Vinton)	13 - 9' x 5.3' CBC	42	7	4,610	FP45 CV IH-10 On-Ramp	NA	6,070	2,910
Flow Path Number 45 (Vinton)	2 - 8' x 3' CBC	43	11	303	FP45 CV Kiely Rd	NA	6,070	1,020
Flow Path Number 45 (Vinton)	4 - 36" Circular	67	16	348	FP45 CV A P Ramirez	NA	6,201	6,201
Flow Path Number 45 (Vinton)	2 - 6' x 6' CBC	70	16	915	FP45 CV Doniphan Dr	NA	6,201	6,201
Flow Path Number 45 (Vinton)	Bridge	19	16	3,555	FP45 Railroad	NA	6,201	6,201
Flow Path Number 45A	3 - 54" Circular	341	16	189	FP45A IH-10	NA	189	189
Flow Path Number 45A	5 - 48" Circular	73	17	788	FP45A - Lovena Way	NA	788	1,050
Flow Path Number 45A	3 - 30" Circular	38	9	116	FP45A Iron Dr	NA	1,050	630
Flow Path Number 45A	2 - 30" Circular	47	8	71	FP45A Kiely Rd	NA	1,050	1,050

Table B-10. Culvert Capacity Summary - Canutillo Study Area

Channel	Dimensions	Length (ft)	Velocity (ft/s)	Crossing Capacity (cfs)	Crossing Location	HMS Node ID	100-Year Flow (cfs)	Channel Capacity
First Avenue Channel	2 - 6' x 3' CBC	89	3.6	130	Doniphan Drive	A_FAC_1	533	137
Flow Path Number 42	2 - 8' x 8' CBC	74	17.4	1,255	Los Vecinos	J_FPN42A,3	1,527	1,527
Flow Path Number 42	2 - 8' x 8' CBC	74	15.3	977	Los Poblanos	J_FPN42A,3	1,527	1,527
Flow Path Number 42	2 - 8' x 8' CBC	93	19.4	1,527	Loas Mochis	J_FPN42A,3	1,527	1,527
Flow Path Number 42	3 - 8' x 8' CBC	92	18.1	1,578	El Chanate	J_FPN42_2	1,578	1,537
Flow Path Number 42	8 - 5' x 5' CBC	67	8.0	1,578	Doniphan Drive	J_FPN42_2	1,578	571

Table B-11. Culvert Capacity Summary - Socorro Study Area

Channel	Dimensions	Length (ft)	Velocity (ft/s)	Crossing Capacity (cfs)	Crossing Location	HMS Node ID	100-Year Flow (cfs)	Channel Capacity
Mesa Spur Drain	1 - 48" CMP	40	9.4	118	Anderson	N/A	N/A	275
Mesa Spur Drain	1 - 48" CMP	50	10.0	126	Carr Rd	N/A	N/A	335
Mesa Spur Drain	1 - 48" CMP	40	10.7	135	Coker	N/A	N/A	330
Mesa Spur Drain	1 - 60" CMP	65	9.4	185	Mesa Drain	N/A	N/A	480
Arroyo 5	2 - 8' x 8' CBC	69	20.2	1,420	IH-10	A_Stream 5-2	185	N/A
Arroyo 5.5	2 - 10' x 10' CBC	81	21.1	2,045	IH-10	A_Stream 5.5-2	308	N/A

Table B-12. Culvert Capacity Summary - Hacienda Real Study Area

Channel	Dimensions	Length (ft)	Velocity (ft/s)	Crossing Capacity (cfs)	Crossing Location	HMS Node ID	100-Year Flow (cfs)	Channel Capacity
Mesa Drain	1 - 60" RCP	65	14.4	245	Northloop	N/A	N/A	320
Mesa Drain	1 - 42" CMP	132	10.4	99	FM 1110/Clint Cut Off	N/A	N/A	870
Mesa Drain	1 - 36" RCP	128	77.6	549	Salatral Lateral	N/A	N/A	970
Mesa Drain	1 - 72" CMP	139	13.1	322	Fenter	N/A	N/A	230
Mesa Drain	1 - 54" CMP	60	10.2	162	1000 US of Celum	N/A	N/A	670
Mesa Drain	1 - 36" CMP	63	11.7	82	Celum	N/A	N/A	590
Stream 6	4 - 7' x 4' CBC	76	18.0	1,238	IH-10	A_Stream 6-2	111	N/A
Stream 7	3 - 10' x 10' CBC	74	20.3	1,630	IH-10	J_AS7-3	2,084	N/A
Stream 7	5 - 48" CMP	130	13.5	733	Bridgeway	J_AS7-2	2,090	N/A
Stream 8	2 - 10' x 6' CBC	70	18.5	832	IH-10	J_AS8-3	309	N/A
Stream 9	2 - 10' x 6' CBC	67	19.5	1,458	IH-10	J_AS9-2	39	N/A
Stream 10	3 - 54" RCP	86	16.8	428	IH-10	J_AS10-2	26	N/A
Stream 11	4 - 54" RCP	85	16.3	673	IH-10	J_AS11-2	576	N/A
Stream 12	4 - 60" RCP	93.8	18.4	962	IH-10	A_Stream 12-4	106	N/A
Stream 13	5 - 60" RCP	99.7	17.0	1,368	IH-10	A_Stream 13-2	99	N/A
Stream 13.5	5 - 9' x 5' CBC	76	22.6	2,476	IH-10	J_AS13.5-3	1,609	N/A

Table B-13. Culvert Capacity Summary - Fabens Study Area

Channel	Dimensions	Length (ft)	Velocity (ft/s)	Crossing Capacity (cfs)	Crossing Location	HMS Node ID	100-Year Flow (cfs)	Channel Capacity
San Felipe Arroyo	Bridge	130	6.7	629	IH-10	R_SFA_1	629	629
San Felipe Arroyo	4 - 60" RCP	58	14.4	313	Citizen Transfer Road	R_SFA_1	629	629
San Felipe Arroyo	12' x 6' CBC	88	12.6	390	Fabens Road	R_SFA_1	629	629
San Felipe Arroyo	5 - 8.5' x 4' CBC	39	5.1	629	Camp Street	R_SFA_1	629	629
San Felipe Arroyo	5 - 8' x 4' CBC	24	4.8	629	Railroad	R_SFA_1	629	629
San Felipe Arroyo	10 - 4' x 4' CBC	44	5.3	629	Alameda Avenue/Old Spanish Trail	R_SFA_1	629	629

Table B-14. Culvert Capacity Summary - Tornillo Study Area

Channel	Dimensions	Length (ft)	Velocity (ft/s)	Crossing Capacity (cfs)	Crossing Location	HMS Node ID	100-Year Flow (cfs)	Channel Capacity
Tornillo Handle Channel 2	2 - 36" x 19" Arch	70	8.95	27	OT Smith Road	A_THC2_2	53	53

This page was intentionally left blank.

FIGURES

This page was intentionally left blank.



Legend

- HECRAS-Modeled Stream
- Study Area
- Major Road
- Railroad
- State Boundary
- County Boundary
- Corporate Boundary
- Military Boundary
- Park Boundary
- Designated Place
- Watershed Area

Elevation:

- 7,616
- 7,000
- 6,500
- 6,000
- 5,500
- 5,000
- 4,500
- 4,000

N

0 2 4 Miles

1 : 253,440 or 1 inch = 4 miles

Master Plan Study Areas
 El Paso County
 Stormwater Master Plan

August 2010 Figure B-1

File: P:\GIS\Projects\EP\CountySMP\MXD\Report\FB-1_MasterPlanStudyAreas.mxd

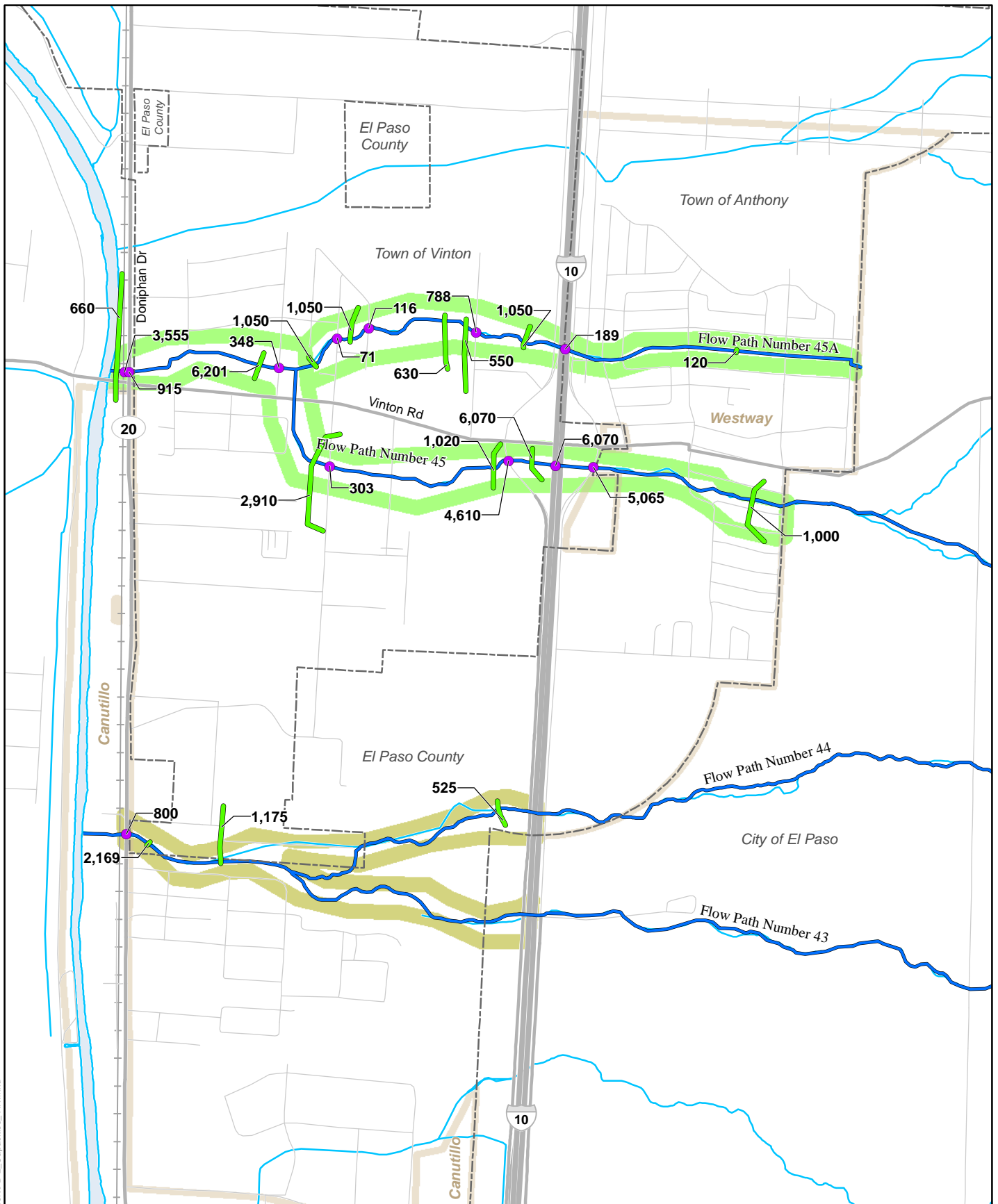

P:\GIS_Projects\EP\WUC\county\SMP\MXD\Report\FB-2_Capacities_VIN.mxd



0 1,000 2,000
 Feet
 1 : 24,000 or 1 inch = 2,000 Feet



URS

Legend

- █ Channel Capacity
- Crossing Capacity
- Study Reach
- █ Study Area
- █ City Master Plan Study Area
- Corporate Boundary
- █ Designated Place
- River, Stream, Canal
- Water Body
- Major Road
- Minor Road
- Railroad

**Channel and Crossing Capacities
 Vinton Study Area**

El Paso County
 Stormwater Master Plan

August 2010

Figure B-2

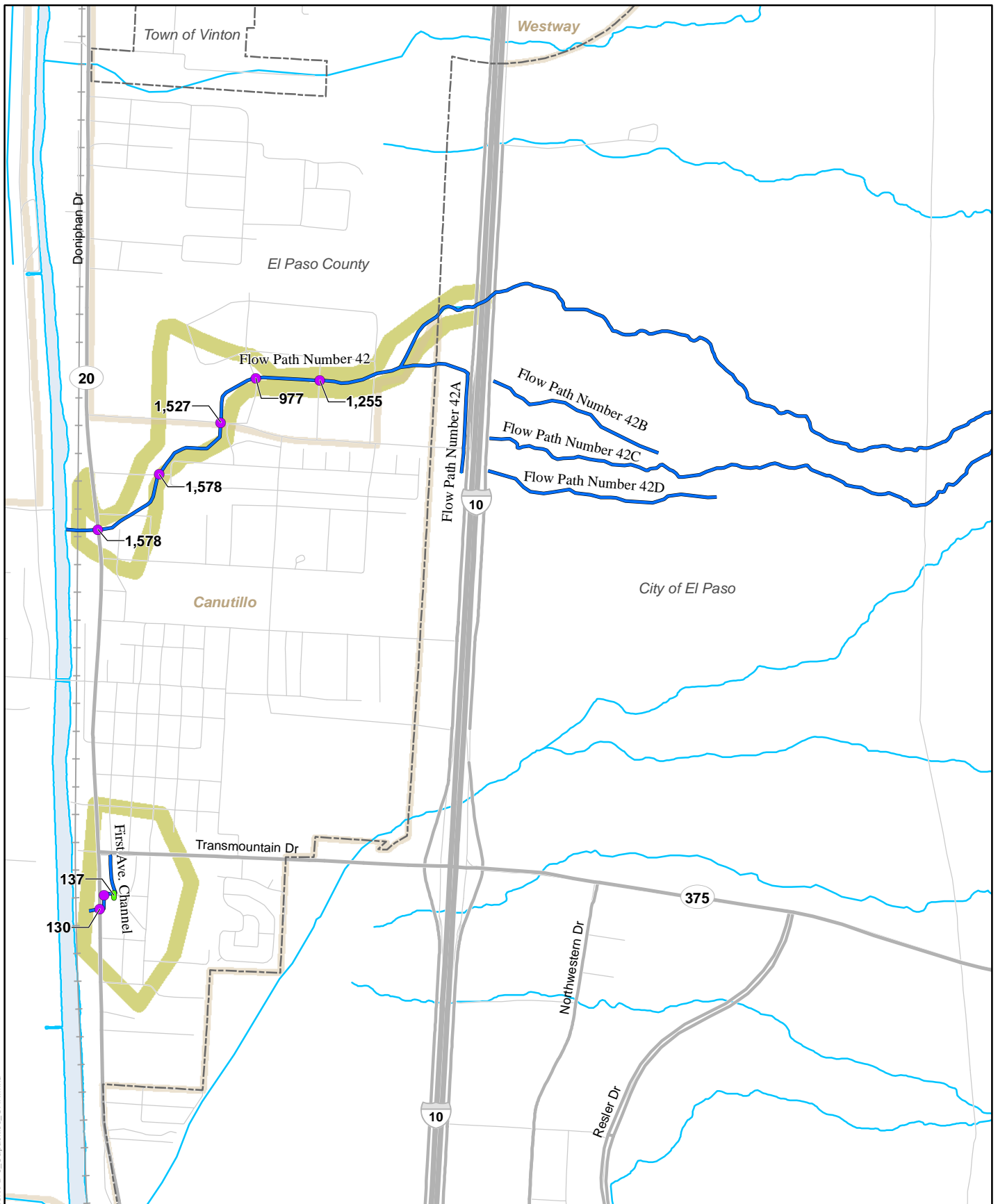

P:\GIS_Projects\EP\WUC_county\SMP\MXD\Report\FB-3_Capacities_CAN.mxd



0 1,000 2,000
 Feet
 1 : 24,000 or 1 inch = 2,000 Feet



URS



Legend

- Crossing Capacity
- Channel Capacity
- Study Reach
- Study Area
- - - Corporate Boundary
- Designated Place
- River, Stream, Canal
- Water Body
- Major Road
- Minor Road
- Railroad

**Channel and Crossing Capacities
 Canutillo Study Area**

El Paso County
 Stormwater Master Plan

August 2010

Figure B-3

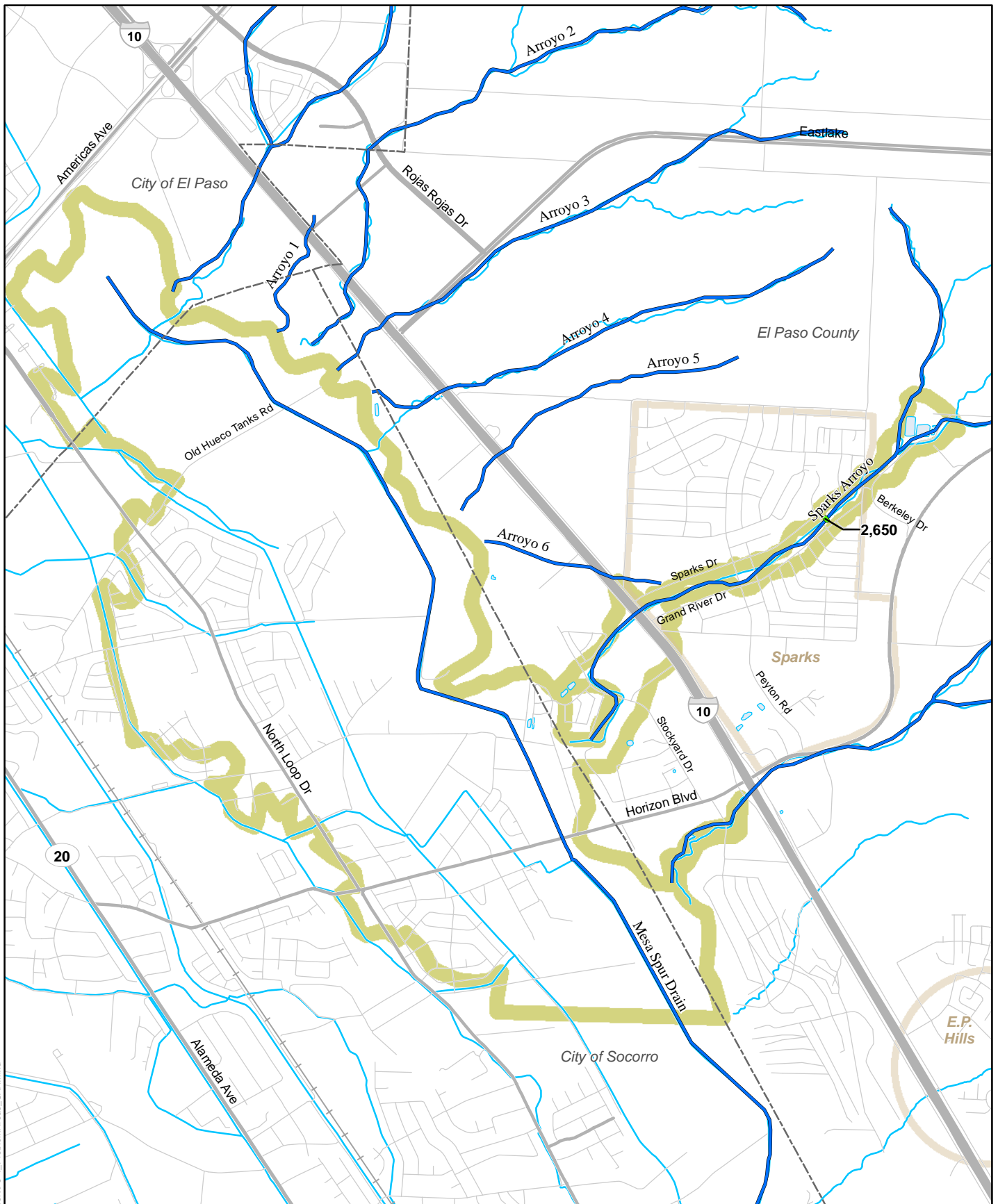

P:\GIS_Projects\EP\WUC_county\SM\PM\XD\Report\ES-4_ProblemAreas_SAA.mxd



0 1,500 3,000
 Feet
 1 : 36,000 or 1 inch = 3,000 Feet



URS

Legend

- █ Channel Capacity
- █ Study Reach
- Study Area
- - - Corporate Boundary
- Designated Place
- River, Stream, Canal
- ☁ Water Body
- Major Road
- Minor Road
- + Railroad

**Channel and Crossing Capacities
 Sparks Arroyo and Sub Basin A
 Study Area**

El Paso County
 Stormwater Master Plan

August 2010

Figure B-4

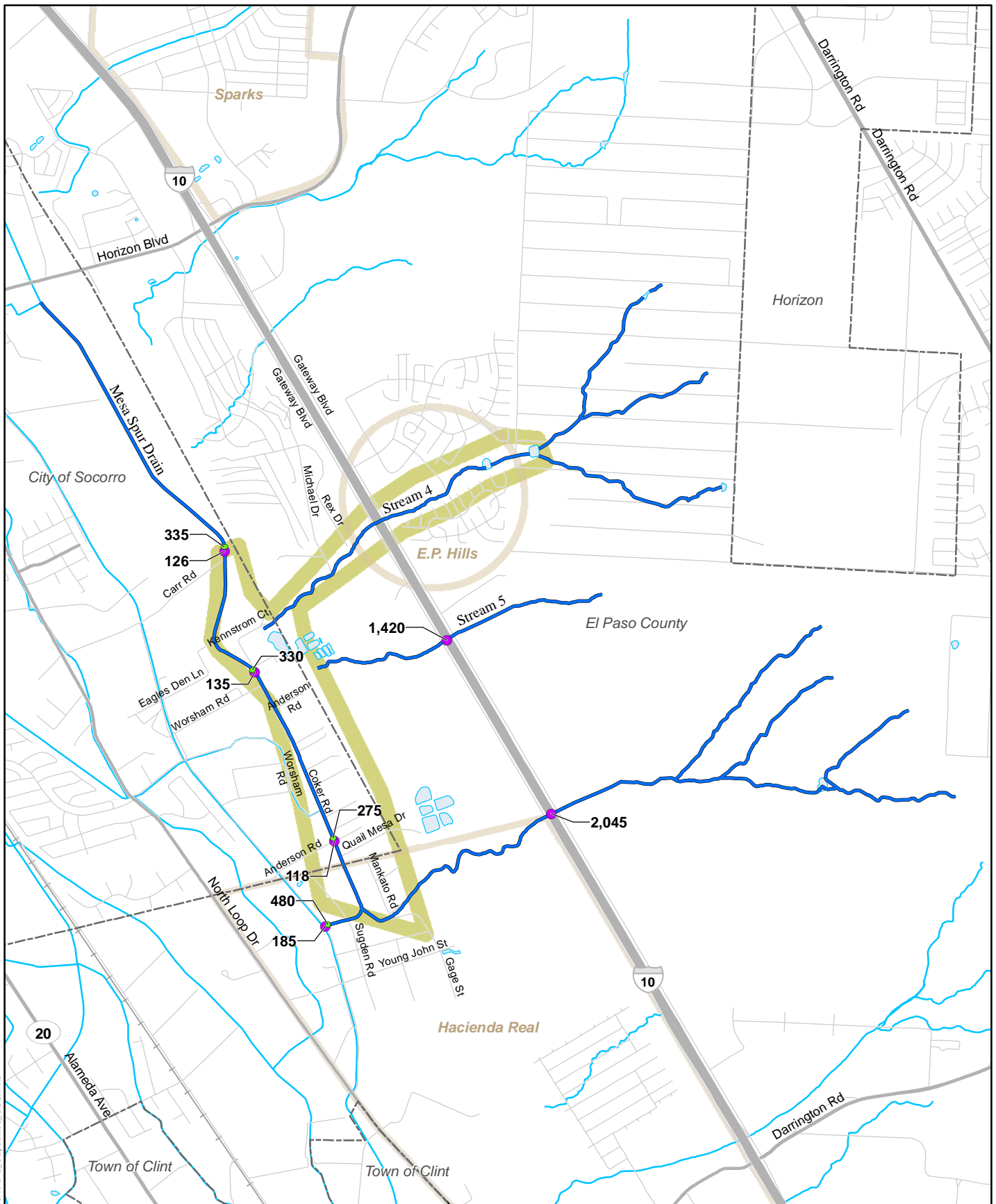

P:\GIS_Projects\EP\WUC\county\SMP\MXD\Report\FB-5_Capacities_SOC.mxd



0 1,600 3,200
 Feet
 1 : 38,400 or 1 inch = 3,200 Feet

Legend

- Crossing Capacity
- Channel Capacity
- Study Reach
- Study Area
- Corporate Boundary
- Designated Place
- River, Stream, Canal
- Water Body
- Major Road
- Minor Road
- Railroad

**Channel and Crossing Capacities
 Socorro Study Area**

El Paso County
 Stormwater Master Plan



August 2010

Figure B-5

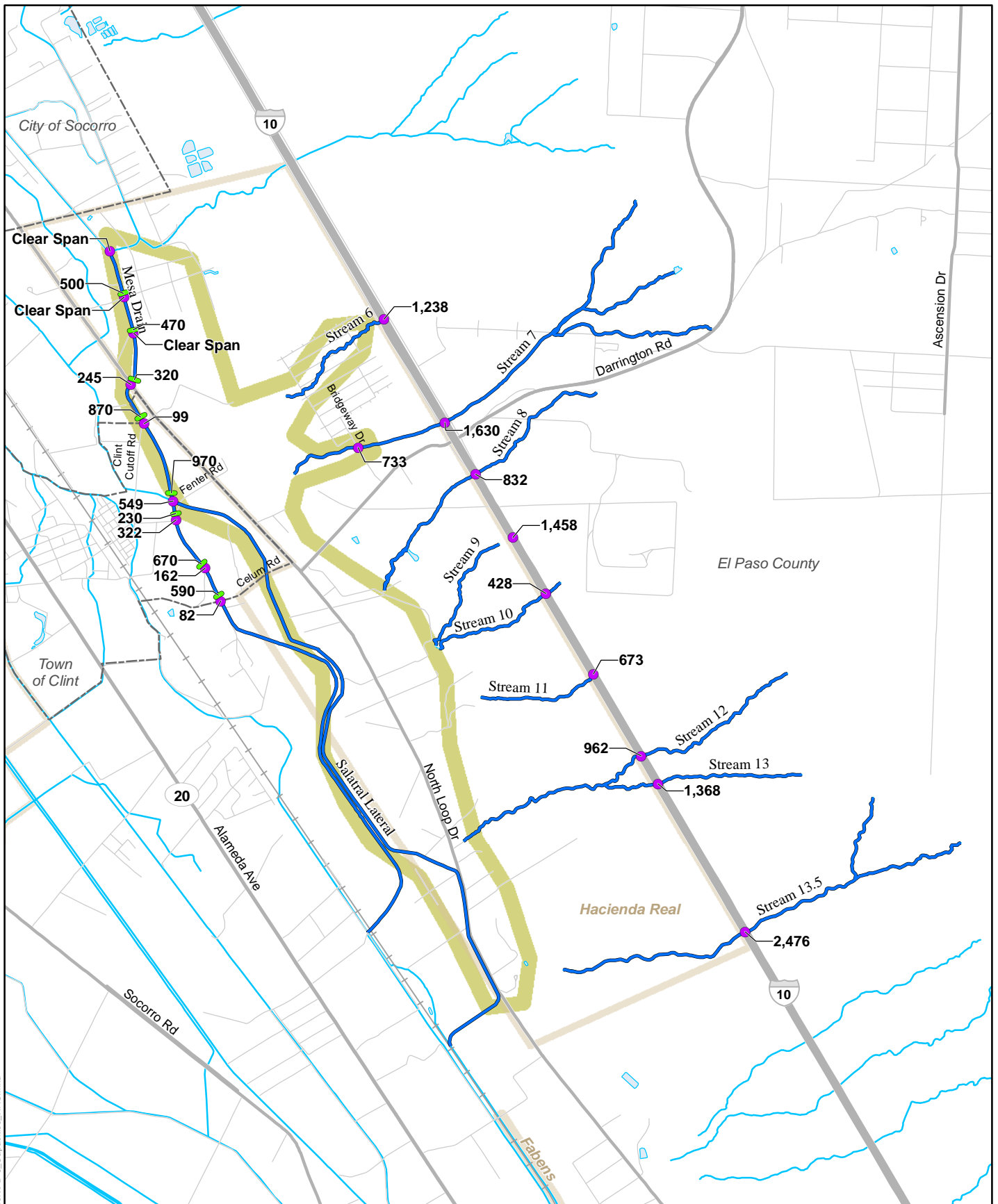

P:\GIS_Projects\EP\WUC\county\SMP\MXD\Report\FB-6_Capacities_HAC.mxd



0 2,000 4,000
 Feet
 1 : 48,000 or 1 inch = 4,000 Feet



URS

Legend

- Channel Capacity
- Crossing Capacity
- Study Reach
- Study Area
- - - Corporate Boundary
- Designated Place
- River, Stream, Canal
- Water Body
- Major Road
- Minor Road
- + Railroad

**Channel and Crossing Capacities
 Hacienda Real Study Area
 El Paso County
 Stormwater Master Plan**

August 2010

Figure B-6

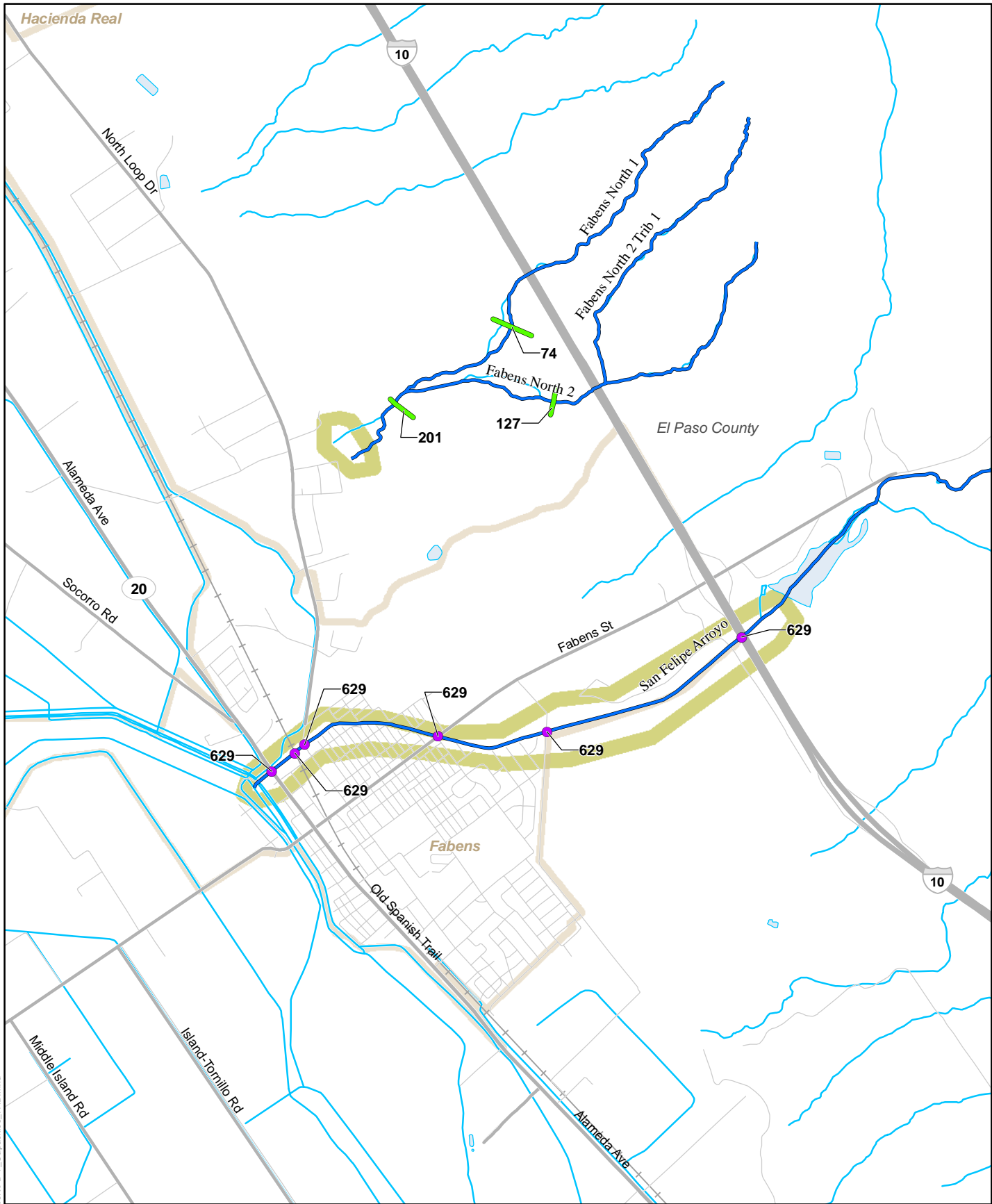

P:\GIS_Projects\EP\WUC_county\SM\PM\XD\Report\FB-7_Capacities_FAB.mxd



0 1,500 3,000
 Feet
 1 : 36,000 or 1 inch = 3,000 Feet



URS

Legend

- Crossing Capacity
- Channel Capacity
- Study Reach
- Study Area
- Corporate Boundary
- Designated Place
- River, Stream, Canal
- Water Body
- Major Road
- Minor Road
- Railroad

**Channel and Crossing Capacities
 Fabens Study Area**

El Paso County
 Stormwater Master Plan

August 2010

Figure B-7

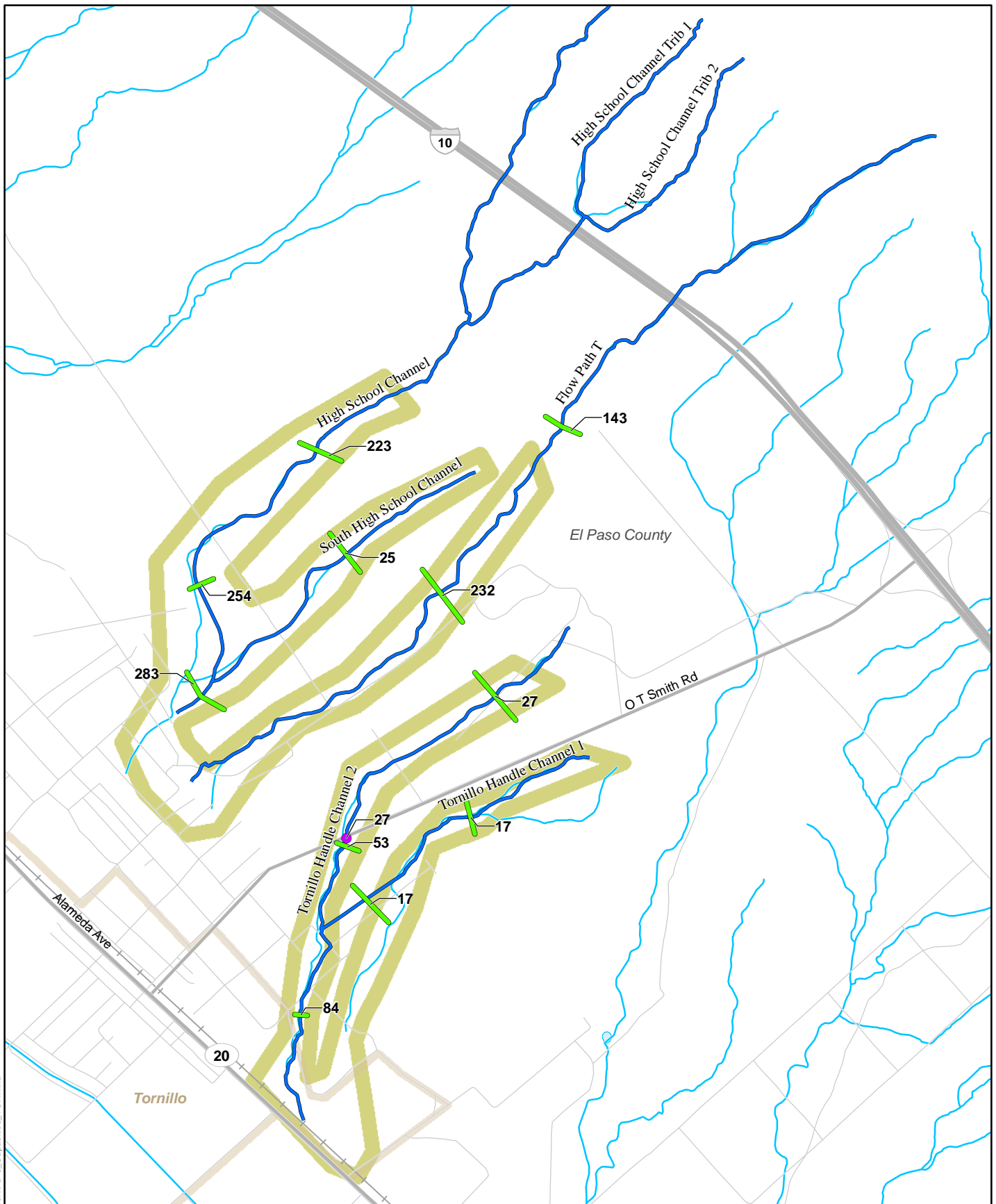

P:\GIS_Projects\EP\WUC\county\SMP\MXD\Report\FB-8_Capacities_TOR.mxd



0 1,000 2,000
 Feet
 1 : 24,000 or 1 inch = 2,000 Feet



URS

Legend

- Crossing Capacity
- ▬ Channel Capacity
- ▬ Study Reach
- Study Area
- Corporate Boundary
- Designated Place
- ▬ River, Stream, Canal
- ▬ Water Body
- ▬ Major Road
- ▬ Minor Road
- + Railroad

**Channel and Crossing Capacities
 Tornillo Study Area**

El Paso County
 Stormwater Master Plan

August 2010

Figure B-8

APPENDIX C

PROJECT ALTERNATIVES EVALUATION AND SELECTION

This page was intentionally left blank.

TABLE OF CONTENTS

<u>Section</u>	<u>Page</u>
C.1.0	GENERAL 1
C.2.0	COST ESTIMATION PROCEDURES 3
C.2.1	Road Crossings 3
C.2.1.1	General..... 3
C.2.1.2	Cost Basis 3
C.2.2	Basins..... 4
C.2.2.1	General..... 4
C.2.2.2	Cost Basis 4
C.2.3	Storm Drains 5
C.2.3.1	General..... 5
C.2.3.2	Cost Basis 5
C.2.4	Channels 6
C.2.4.1	General..... 6
C.2.4.2	Cost Basis 6
C.2.5	Markups to Construction Cost 7
C.3.0	IMPROVEMENT CONCEPT DESIGN..... 9
C.3.1	Road Crossings 9
C.3.1.1	Methodology..... 9
C.3.1.2	Results 9
C.3.2	Basins..... 9
C.3.2.1	Methodology..... 9
C.3.2.2	Results 13
C.3.3	Storm Drains 13
C.3.3.1	Methodology..... 13
C.3.3.2	Results 13
C.3.4	Channels 13
C.3.4.1	Methodology..... 13
C.3.4.2	Results 13
C.4.0	ALTERNATIVE COST ESTIMATION 15
C.5.0	ALTERNATIVE QUALITATIVE EVALUATION AND SELECTION 17
C.5.1	Undersized Existing Flood Channel Alternatives 17
C.5.1.1	Vinton Flow Path Number 44..... 17
C.5.2	Currently Unprotected Watersheds 18
C.6.0	PRIORITIZATION..... 21
C.6.1	Assignment of Risk Factors for Stormwater Issues of Concern..... 21
C.6.1.1	Assignment of Flood Risk Reduction Benefit for Real Property..... 21
C.6.1.2	Assignment of Flood Risk Reduction Benefit for Arterials .. 24
C.6.1.3	Assignment of Benefit for Maintenance Reduction..... 25

C.6.1.4	Assignment of Total Risk Reduction Benefit.....	25
C.6.2	Assignment of Priority Categories	25
C.6.3	Assignment of Priority Within Category I	25
C.6.4	Discussion of Alternatives to 100-Year Level of Protection	26

LIST OF TABLES

Table C-1	Summary of Significant Cost Factors/Unit Costs	29
Table C-2	Summary of Crossing Concept Designs	30
Table C-3	Summary of Basin Concept Designs	31
Table C-4	Summary of Storm Drain Concept Designs	34
Table C-5	Summary of Channel Concept Designs	36
Table C-6	Alternative Costing Table.....	37
Table C-7	Comparisons of Detention vs Retention.....	47
Table C-8	Stormwater Projects.....	48
Table C-9	Return Interval Analysis for Proposed Basins	56
Table C-10	Risk Reduction Benefit.....	58
Table C-11	Total Risk Reduction Benefit.....	60
Table C-12	Prioritization Summary.....	62

LIST OF FIGURES

Figure C-1	Cost per Square Foot of Flow Area vs. Flow Area of Culverts.....	66
Figure C-2	URS Basin Conceptual Design Embankment Stabilization Materials	67

C.1.0 GENERAL

Each developed alternative for drainage improvement was evaluated through the following general process:

- A set of general concept design level cost estimation procedures were developed for each generic type of improvement, specifically:
 - Road crossings
 - Detention/retention dams/basins
 - Storm drains
 - Channels
- The individual improvements (new culverts; new/expanded channels; new/expanded detention, etc.) associated with each project were sized using refined hydrologic and hydraulic analyses.
- The improvement sizes and other site information were input into the developed cost estimation procedures to obtain an estimated construction cost for each improvement. Costs of individual improvements associated with each project were summed to develop estimated project total costs.
- Finally, the most favorable alternative was selected for each project.

This appendix will present the basic methodologies associated with this evaluation process.

This page was intentionally left blank.

C.2.0 COST ESTIMATION PROCEDURES

The basic sources used for unit costs for all cost analyses were cost data available from the Texas Department of Transportation (TxDOT), the Natural Resources Conservation Service (NRCS) bid tabs, and bid tabs and other cost data provided by the City of El Paso and/or El Paso Water Utilities (EPWU). Specific sources are detailed in Table C-1.

C.2.1 Road Crossings

C.2.1.1 General

In many instances, a component of a drainage improvement alternative included the construction of a new drainage structure or improvement to an existing drainage structure under a road to meet project flood protection criteria (e.g. protection of road/railroad overtopping for the 100-year or 1 percent (%) annual exceedance probability flood). The estimated cost of construction generally consisted of the following significant components:

- Excavation;
- Conduit materials;
- Road surface repair; and
- Utility relocation.

C.2.1.2 Cost Basis

Excavation unit cost was estimated at \$5.00 per cubic yard, derived from recent El Paso TxDOT bid tabs. Unit costs for asphalt and concrete road surface repair were estimated at \$50.00 per square yard and \$54.00 per square yard, respectively. These estimated costs were derived from Statewide TxDOT bid tabs.

TxDOT bid tabs were initially used as the primary source for conduit materials costs. During review of costs estimated for project alternatives, it became apparent that use of the TxDOT data led to some significant inconsistencies in conduit costs, i.e. small conduits could have costs per unit length higher than significantly larger conduits. To address this issue a scattergram of current costs was developed versus conduit area (see Figure C-1). From this figure, a conservative cost estimate of \$25.00 per square foot of conduit area per foot of length was used for road crossing structure cost.

The cost of utility relocation was accounted for as a percentage of the estimated construction costs for road crossing improvements. Road crossing improvements were evaluated against historical data and estimated to require major, minor, or no utility relocation. Primary evaluation factors included extent of widening and urbanization along the route. For projects expected to have minor effect on existing utilities, estimated construction costs were increased by 10%; for projects expected to have major effect on existing utilities, estimated construction costs were increased by 50%.

C.2.2 Basins

C.2.2.1 General

In many instances, a component of a drainage improvement alternative included the construction of a new or expanded basin for the retention of sediment, and/or the retention or detention of floodwater. The estimated cost of construction generally consisted of the following significant components:

- Cost of excavation;
- Cost of embankment materials (semi-impervious fill, filter drain, etc);
- Cost of riprap for the upstream slope of embankments (for basins including aboveground storage);
- Cost of principal outlet (for basins including aboveground storage): The principal outlet is used to drain the basin flood pool slowly following a flood;
- Cost of auxiliary spillway (for basins including aboveground storage): The auxiliary spillway is used to drain the reservoir when the flood pool is filled, and serves the function to prevent overtopping of the dam crest;
- Cost of excess spoil disposal. For cases where an embankment was constructed to provide above ground detention, the estimated embankment volume was subtracted from the volume of excavation to obtain volume of excavation spoil; and
- Land acquisition.

C.2.2.2 Cost Basis

Excavation unit cost was estimated at \$5.00 per cubic yard, derived from recent El Paso TxDOT bid tabs. The unit cost applied for disposal of excess excavation spoil was \$5.00 per cubic yard, derived from recent EPWU experience. The cost of 18-inch riprap was estimated at \$84.00 per cubic yard, derived from recent Statewide TxDOT bid tabs. The cost for principal outlet construction was based upon conduit cost and estimated length per cost basis described in Section C.1.1.

The embankment materials unit cost estimates were derived from NRCS bid tabs and engineering judgment. Material quantities were estimated based upon a generic embankment design (Figure C-2). The following unit costs were used for embankment materials:

- Unit cost of earth work was estimated to be \$5.00 per cubic yard;
- Unit cost of clay embankment fill was estimated to be \$25.00 per cubic yard;
- Unit cost of coarse drainfill was estimated to be \$50.00 per cubic yard;

- Unit cost of polyurethane membrane was estimated to be \$0.50 per square foot; and
- Unit cost of geotextile was estimated to be \$0.15 per square foot.

In the case of land acquisition for projects involving basins, the property value for each affected parcel was determined by accessing the county property records site (www.elpasocad.org) for the property of interest. A portion of the property value, based on the percentage of the parcel that would be required for the improvements, was estimated to be the value of the affected property. In most cases, if more than 60% of the parcel was affected by the basin, or the portion required would greatly decrease the utility of the parcel, it was decided that the entire parcel would be acquired. An adjustment factor was applied to the estimated affected property value to calculate the estimated price of acquisition. If the property was in a developed area, the assessed value was multiplied by three. If the property was in an undeveloped area or an area with little development, the assessed value was multiplied by two.

C.2.3 Storm Drains

C.2.3.1 General

In one instance, a component of a drainage improvement alternative included the construction of a new conduit for the conveyance of floodwater. The estimated cost of construction generally consisted of items such as excavation, bedding and backfill, utility relocation, street repair, curb and gutter repair, and traffic control.

C.2.3.2 Cost Basis

For conduit placement, a cost per linear foot was used to estimate the total project cost. This cost per linear foot included a number of significant project elements that could not be estimated in detail: relocation of major utilities (water/sewer/electrical line, installation of curb and gutter, road repair, traffic control, etc.). The best sources for estimation of this factor were recent City of El Paso bid tabulations at http://www.elpasotexas.gov/financial_services/bid_tabs.asp. The cost per linear foot estimation process included the following:

- The over 500 bid tabs available on the website were reviewed for applicability to this project. Specifically, to be relevant, projects had to be focused on installation of new large diameter conduits (36 inches or greater) through an existing urban area. Two projects were identified: Upper Valley Drainage Improvements Phase III and Davis Drive Street and Drainage Improvements; and
- The total cost of each project was divided by a length of right-of-way disturbed associated with the project to determine a cost per linear foot.

The estimated cost per linear foot used in this analysis, derived from the method described above, was \$1,105.00 per linear foot for 48-inch reinforced concrete pipe (RCP) and \$820.00 per linear foot for 36-inch RCP. In project cost estimation, this cost

per linear foot was only applied to the construction of a single barrel in a multiple barrel conduit. The cost for the remaining barrels was estimated to be \$97.00 per linear foot for 48-inch RCP and \$66.00 per linear foot, based on cost data from TxDOT bid tabs.

C.2.4 Channels

C.2.4.1 General

In many instances, a component of a drainage improvement alternative included the construction of a new channel, or improvement to an existing channel. The estimated cost of construction generally consisted of the following significant components:

- Excavation;
- Concrete channel lining;
- Utility relocation; and
- Land acquisition.

C.2.4.2 Cost Basis

Excavation unit cost was estimated at \$5.00 per cubic yard, derived from recent El Paso TxDOT bid tabs. Concrete channel lining unit cost was estimated at \$88.00 per square yard, also derived from recent statewide TxDOT bid tabs.

The cost of utility relocation was accounted for as a percentage of the estimated construction costs for channel improvements. Channel improvements were evaluated against historical data and estimated to require major, minor, or no utility relocation. Primary evaluation factors included extent of widening and urbanization along the route. For projects expected to have minor effect on existing utilities, estimated construction costs were increased by 10%; for projects expected to have major effect on existing utilities, estimated construction costs were increased by 50%.

In the case of land acquisition for projects involving channels, the property value was determined by accessing the county property records site (www.elpasocad.org) for the property of interest. A portion of the property value, based on the percentage of the parcel that would be required for the improvements, was estimated to be the value of the affected property. In most cases, if more than 60% of the parcel was affected by the improvements, or the portion required would greatly decrease the utility of the parcel, it was decided that the entire parcel would be acquired. An adjustment factor was applied to the estimated affected property value to calculate the estimated price of acquisition. If the property was in a developed area, the assessed value was multiplied by three. If the property was in an undeveloped area or an area with little development, the assessed value was multiplied by two. Generally, it was assumed that it would be necessary to acquire property within 20 feet of the channel banks.

C.2.5 Markups to Construction Cost

The subtotal for each component (crossings, basins, storm drains, and channels) was increased by 35% because of the lack of detail at this stage of alternative evaluation. Property acquisition was the exception to this procedure. The estimated cost for property was not increased based on the 35% contingency.

This page was intentionally left blank.

C.3.0 IMPROVEMENT CONCEPT DESIGN

Tables C-2 through C-5 list the principal improvement components of each alternative. This section will describe the concept design of these improvements.

C.3.1 Road Crossings

C.3.1.1 Methodology

Road crossings for each watershed were analyzed using CulvertMaster. Characteristics such as existing invert elevations, length, dimensions, and material were used to develop a maximum capacity. The sources for this information included site visit measurements, survey, and Interstate Highway 10 (IH-10) As-Built Plans (TxDOT, 1957). Each culvert was analyzed, and the maximum capacity was compared to the peak flow (cubic feet per second [cfs]) from the contributing watershed if available. If the contributing watershed was not analyzed (e.g. Mesa Drain and Mesa Spur Drain), then the maximum capacity was compared to the estimated channel capacity. This was used to identify crossings that were potentially undersized. A conceptual design was completed on crossings that did not have an estimated maximum capacity equal to or greater than the 100-year return period (1% annual exceedance probability) flood, or the capacity of the channel.

CulvertMaster was used to estimate the culvert size needed to pass the peak flow without overtopping of the structure (road) to be protected. Channel geometry downstream of each culvert was entered into CulvertMaster to account for tailwater effects. Design parameters entered into CulvertMaster included culvert size, material, and elevations at the inlet, outlet, and top of road. Design culvert sizes were proposed based on the geometry of the channel and the top of road elevation, to ensure that the road could be returned to its original geometry after construction and the required culverts would fit properly. In some instances, it would be necessary to expand the channel at the culvert entrance to adjust for the proposed culvert widths.

C.3.1.2 Results

The material and dimensions of each existing and proposed crossing for selected alternatives are summarized in Table C-2. Other key parameters affecting cost, as well as estimated cost, are also provided in the table.

C.3.2 Basins

C.3.2.1 Methodology

Conceptual designs for three types of proposed basins were developed as part of this El Paso County Stormwater Master Plan (SMP):

- Retention without embankment;
- Retention with embankment; and
- Detention with embankment.

All three basins impound a sediment pool and a flood pool. Initial concept design included basin siting, sizing of the sediment pool, and sizing of the flood pool. Further concept design varied for each of the three types of basins.

Siting of Basins

In general, the locations of the proposed basins were selected based on recommendations from the County or by identifying vacant lands that were suitable locations for stormwater control. In a number of scenarios, analyses demonstrated the need for two basins in series: a basin located in the upstream portion of the watershed and in the lower portion of the watershed.

Sizing of Sediment Pool

The sediment pool is the basin storage volume (acre-feet) allocated for deposition of sediment. Sediment volumes were estimated utilizing the method outlined in the *Sparks Arroyo & SB A Hydraulics* document prepared by the U.S. Army Corps of Engineers (USACE) (USACE, 2007). This report provides a chart that plots annual sediment yield (acre-feet/square mile/year) versus urban development percent. In general, sediment pools were designed to contain two years of watershed average sediment yield.

Sizing of the Flood Pool

The flood pool is the basin storage volume (acre-feet) allocated for floodwaters. Concept design flood pool volumes were set to equal the runoff volume generated by a 100-year, 24-hour storm, as estimated by the program Hydrologic Engineering-Hydrologic Modeling System (HEC-HMS) (documented in Appendix A).

Design of Basins

The design of basins given the site, sediment pool volume, and flood pool volume is described below for each type of basin.

Retention without Embankment. This structure has both the sediment pool and flood pool below grade, i.e. no flood flow or sediment entering the basin is discharged until the basin is filled. Once the basin fills, the basin water level is lowered only by seepage into the ground beneath the basin. Given the expected high permeability of soils at the proposed sites, and the general aridity of the climate, these basins are expected to be dry for the vast majority of the time. Concept design steps included:

- For the length of downstream basin edge appropriate for the site, a basin cross-section was estimated with an area below grade that provided the requisite total storage volume. In general a maximum design depth of 10 feet was assumed, but this was varied when needed per engineering judgment;
- A surface based upon this cross-section, with side slopes above grade into the existing topography of 1 vertical to 4 horizontal, was subtracted from the existing topographic surface to obtain an estimate for needed excavation. This estimate included both the volume of excavation below grade, and the volume of cut into the above grade slopes adjacent to the basin. This estimate is provided as “total excavated volume” in Table C-3.

Embankment Designs, General. For retention and detention basins with embankments, it was necessary to account for above ground storage provided by the embankment. The elevation-storage relationship was estimated based on the 2004 Topography (TXDOT, 2004), and approximated by assuming a vertical wall along the trace of the proposed embankment.

Each embankment was assumed to have a principal spillway, a low level outlet that discharges from the impounded flood pool during and following a flood. The concept design height for each embankment was estimated as the height needed to contain the 100-year, 24-hour flood, given continuous discharge during that flood of the principal spillway. This estimation of needed height was performed within HEC-HMS, using as inputs watershed hydrologic parameters for the 100-year, 24-hour flood (see Appendix A), the derived elevation-storage relationship for the basin, and the hydraulic characteristics of the principal spillway.

The Texas Commission on Environmental Quality (TCEQ) regulates dams in excess of six feet in height, and provides specific detailed guidance on hydraulic adequacy for regulated dams. For SMP embankments estimated to be less than six feet in height, floods in excess of that generated by the 100-year flood were assumed to overtop the structure within an armored swale (to be addressed in later phases of design). Embankments in excess of six feet tall were assumed to require an additional five feet of height above that required to meet flood and sediment pool storage needs. An auxiliary spillway, whose purpose is to prevent embankment overtopping in the regulatory flood, is assumed to have its crest sited at the top of flood pool elevation. The added five feet of embankment is assumed (based upon URS Corporation [URS] experience with similar structures) to be sufficient to allow safe passage of the TCEQ regulatory flood within a reasonable auxiliary spillway width. No modeling of TCEQ regulatory flood or sizing of an auxiliary spillway was performed as part of the SMP. The volume of material required to construct the auxiliary spillway was assumed to be 10% of the total embankment volume.

Dam embankments were designed to include a 20-foot top width and 3 horizontal to 1 vertical side slope. Based on soil survey information, it was estimated the soil excavated from the basins would not be suitable for use in the dam embankment without a semi-impervious barrier. In order to utilize soil excavated from the basin, thus reducing soil disposal and fill material costs, all proposed embankments were designed based on the cross-section shown in Figure C-2. This cross-section is very similar in form to that developed by USACE for the America's Basin, immediately north of Socorro.

To estimate the volume of embankment material required, a calculation was performed within Geographic Information System (GIS) software (ArcView). The calculation required the identification of the proposed embankment centerline on a digital surface created from the 2004 Topography (TXDOT, 2004). The centerline terminated its ends at the concept design maximum embankment elevation. The area variations for a generic dam cross-section (Figure C-2) along the dam centerline (accounting for the

variations in dam height along the centerline) were estimated and summed to provide an estimate of total embankment volume.

In addition to aboveground storage provided by the embankment, designs included excavation within the basin footprint to provide additional storage, typically for the sediment pool. It was desirable to optimize the volume of excavation so that a majority of the material excavated could be utilized in the embankment, reducing the amount of outside fill and soil disposal required. In general, to find the optimum basin configuration the following analysis was performed.

- Estimate the required embankment volume for the maximum basin height required, 6-foot high embankment, and an embankment height that was approximately half of the maximum embankment height (in some cases embankment volumes were estimated for additional embankment heights);
- Develop an Embankment Elevation-Embankment Volume Required curve for the proposed basin location; and
- Utilize the Elevation-Storage curve, the Embankment Elevation-Embankment Volume Required curve, and the required volume of sediment pool storage to estimate the optimum basin configuration for a required combined sediment pool/flood pool volume.

In some cases engineering judgment was used in lieu of the optimization method described above.

Embankment Designs, Retention Basins. For retention basin concept design, the principal spillway was assumed to have the minimal size needed to reduce the frequency of clogging and cleanout. Per design practice of the U.S. Department of Agriculture (USDA) NRCS, the minimum size for a principal spillway is a 30-inch diameter conduit. For the SMP a similarly sized 2-foot by 2-foot concrete box culvert (CBC) was assumed as principal spillway size for retention basins. Required embankment heights for retention basins to contain the design flood were estimated based upon hydrologic modeling assuming this size principal spillway.

Embankment Designs, Detention Basins. For detention basin concept design, the principal spillway was assumed to have a size that discharged a 5-year flood flow rate, given a peak 100-year flood level in the basin. At the start of concept design the required dam height was unknown, and spillway size using this design criterion is a function of dam height. Required embankment heights for detention basins to contain the design flood were therefore estimated based upon iterative hydrologic modeling assuming varying sizes of principal spillway and dam height (until peak discharge matched the 5-year flood).

To provide an estimate of the cost required to construct basins for lesser return interval protections, a cost analysis was performed on four separate basins for the 10-, 25-, and 50-year return intervals. The percentage of the 100-year construction cost for each return interval was estimated for each basin and return interval, and an average

percentage was calculated for each return interval. The results of the analysis are provided in Table C-9. No analysis was performed on the reduction in estimated cost of property, but it was assumed that the percentages of construction costs could be applied to the total basin project cost. The average percentages were applied to all of the basins recommended as part of the County SMP.

C.3.2.2 Results

The dimensions of each proposed basin for selected alternatives are summarized in Table C-3. Other key parameters affecting cost, as well as estimated cost, are also provided in the table.

C.3.3 Storm Drains

C.3.3.1 Methodology

The storm drain conduit was designed using HEC-HMS, as this conduit served as a principal spillway outlet to an existing basin. HEC-HMS inputs include type of conduit, size, material, length, and slope. The material, length, and slope were first entered into the model. The size was then adjusted until the minimum size that would not cause the basin to overtop was determined.

C.3.3.2 Results

The dimensions of the proposed conduit for selected alternatives is summarized in Table C-5. Other key parameters affecting cost, as well as estimated cost, are also provided in the table.

C.3.4 Channels

C.3.4.1 Methodology

Where existing channels were estimated to lack 100-year return period (1% annual exceedance probability) capacity, a concept design was developed to provide additional capacity. This capacity was added either by channel widening or by lining an existing unlined channel. Where an existing Hydrologic Engineering Center-River Analysis System (HEC-RAS) model was available, the model was used in concept design. Where no model was currently available, flow capacity was estimated using a normal depth assumption.

C.3.4.2 Results

The dimensions of each existing (if applicable) and proposed channel for selected alternatives are summarized in Table C-5. Other key parameters affecting cost, as well as estimated cost, are also provided in the table.

This page was intentionally left blank.

C.4.0 ALTERNATIVE COST ESTIMATION

The improvements per the types and dimensions developed in concept design (Section C.3.0) were cost estimated per the procedures presented in Section C.2.0. The resulting costs are presented in Table C-6.

This page was intentionally left blank.

C.5.0 ALTERNATIVE QUALITATIVE EVALUATION AND SELECTION

In previous sections, projects were developed to address identified priority stormwater and sediment management concerns within the county. In several cases, alternative projects were developed to address the same concern. Alternatives generally were devised for each for of these situations:

Undersized Existing Flood Channel

The proposed alternatives were either to 1) improve the existing channel, or 2) build upstream detention/retention to reduce flood flows to a level within the flood capacity of the existing channel.

Currently Unprotected Watersheds

In these cases, communities and properties were undergoing flooding and excess sediment deposition during routine storms. The proposed solutions included siting of basin(s) to intercept flood waters and sediment. The basins were designed in two alternative configurations: retention or detention. In the retention alternative, the basin was designed to have a 100-year flood pool with a small low flow outlet. In this case, flow below flood levels was released from the basin downstream during floods from the upstream watershed. In the detention alternative, the low flow outlet was designed to allow a five-year flood to proceed downstream. The detention basin would significantly lower inundation-related damages from major floods, and reduce sediment loadings from routine floods, but not materially reduce routine inundation damage. This, in general, would allow for a smaller dam and lower capital costs.

The selection of most favorable alternative for all competing alternatives was performed in a URS Corporation (URS)-led workshop with the following entities represented:

- EPWU;
- El Paso County;
- City of Socorro;
- Village of Vinton; and
- Texas Water Development Board (TWDB).

The following sections summarize the reasoning underlying alternatives selection.

C.5.1 Undersized Existing Flood Channel Alternatives

Alternatives were proposed to address flooding in existing channels in Vinton Flow Path Number 44, and Canutillo Flow Path Number 42.

C.5.1.1 Vinton Flow Path Number 44

Table C-6 provides a comparison of projects VIN5_1 (Channel Improvements), VIN5_2 (Detention Basin VIN5_2), and VIN5_3 (Retention Basin VIN5_2). The estimated total

cost for channel improvements was \$860,000; while the cost for the basin alternatives varied between \$12.8M and \$16.2M. Given the wide disparity in cost for comparable benefits, the channel improvement alternative (VIN5_1) was selected in preference to the other two.

Canutillo Flow Path Number 42. Table C-6 provides a comparison of projects CAN1_1 (Channel Improvements), CAN1_2 (Detention Basin CAN1_2), and CAN1_3 (Retention Basin CAN1_3). The estimated total cost for channel improvements was \$1.4M; while the cost for the basin alternatives varied between \$3.7M and \$7.5M. Given the wide disparity in cost for comparable benefits, the channel improvement alternative (CAN1_1) was selected in preference to the other two.

C.5.2 Currently Unprotected Watersheds

As noted above, the projects proposed for currently unprotected communities and properties generally consisted of upstream construction of a stormwater and sediment basin. The retention alternative reduces 100-year floods to minor flows and provides major improvements in sediment reduction.

The detention alternative provides major improvements in sediment reduction, but essentially reduces 100-year floods to five-year floods. In the detention alternative, communities and properties currently undergoing routine flooding (flooding that occurs on average more frequently than once in five years) will still have regular flooding issues. Communities and properties outside the 5-year floodplain would be protected from the 100-year flood. For full protection against routine floods, some future projects would need to be devised to channel the 5-year flood to a drainage structure/drain with sufficient capacity to accept the flow; or the basin would need to be expanded to a retention configuration.

In short, the retention alternative is generally preferable to the detention alternative, if the costs for the two alternatives are reasonably similar. Two of the projects with alternatives in Table C-7 (CAN3, TOR1) do not involve detention versus retention alternatives, but involve alternative configurations of retention (higher dam, less excavation; versus lower dam, more excavation). In these two cases, alternative selection was purely based upon cost.

Alternatives involving detention and retention configurations of basins in the same location are presented in Table C-7. Table C-7 compares detention versus retention configuration cost, and provides a rough estimate of properties and roads potentially impacted by a 100-year flood event in the current, unprotected condition. A column in the table provides an estimate of the increase in cost (in terms of % of total cost) to provide retention in lieu of detention. The derivation of data for flood risk is explained in more detail in Section C.6.0.

In all of these comparisons, with one exception, the increase in cost associated with providing retention versus detention was less than 15%. For these cases (with less

than a 15% increase in cost), a retention alternative (CAN3_2, HAC2_2, HAC3_2, HAC4_2, HAC5_2, HAC6_2, and TOR1_2) was selected.

For Project HAC7, the estimated cost of retention was 39% more expensive than the cost of detention. For this case, the properties estimated to be impacted by routine flooding were almost exclusively agricultural. As the issue of routine concern with agricultural lands is more with sediment deposition than shallow inundation, and the retention and detention basins each provide sediment protection, the detention basin option (HAC7_2) was selected in this case.

Selected alternatives and their associated costs are shown in Table C-8.

This page was intentionally left blank.

C.6.0 PRIORITIZATION

As shown in Table C-8, the SMP identified 55 projects with a total estimated cost exceeding \$150 million. The next task was to develop a method for prioritizing the projects so that they could eventually be incorporated into a Capital Improvement Program (CIP).

The first task of the prioritization process was to identify the major concerns associated with stormwater management. The major concerns identified to be addressed by the stormwater improvements were:

- Reduce flooding of real property (residences, commercial, and agricultural land);
- Reduce uncontrolled sediment deposition;
- Reduce flooding of critical transportation arteries (e.g. IH-10, Doniphan Road); and
- Reduce maintenance.

The second task was to develop relative risk index values for each of the above issues for each project. The third task was to use these relative risk index values to assign a priority category (I, II, or III) to each task. The final task was to rank those projects in Category I into three subcategories (high, medium, and low priority).

Finally, a discussion is included on the opportunities to reduce costs for major capital projects, via staging and downsizing to allow for more initial risk.

C.6.1 Assignment of Risk Factors for Stormwater Issues of Concern

C.6.1.1 Assignment of Flood Risk Reduction Benefit for Real Property

C.6.1.1.1 Qualitative Assessment of Flood Risk Reduction Benefit for Each Project

The existing flooding of real property was estimated as follows, for each area to be protected by the proposed projects. The method varied by type of flooding reduced: overbank flooding from an existing channel; or overland flooding associated with the outlet of the terminus of an arroyo.

Overland Flooding from an Existing Channel

This issue applies to Vinton Flow Path Nos. 44 and 45, Canutillo Flow Path Number 42, Sparks Channel, San Felipe Arroyo through Fabens, High School Channel (Fabens), and Tornillo Handle Channel 2. In these cases, the residences that would be inundated the most often and to the greatest depth, those adjacent to the channel reach to be improved were counted.

Overland Flooding Associated with the Terminus of an Arroyo

All of the proposed basin projects improve downstream flooding and sediment loading associated with the terminus of an arroyo. In these cases, routine storms historically have largely infiltrated into the ground or into the bed of the arroyo, making flows out of the terminus of the arroyo (where the arroyo banks lose definition and flatten out into the flat valley of the Rio) relatively rare occurrences. During extreme, relatively long duration storms (like the August 2006 series of storms) the ground is saturated, the arroyo bed is saturated, and significant flow is discharged through the arroyo outlet onto developed (residential, commercial, or agricultural) property. The project sites selected generally provide protection where such property has generally been unprotected. The flooding problem is worsened by another result of extreme, long duration storms: the saturation of unvegetated or poorly vegetated ground and arroyo banks mobilizes sediment which stays in suspension or moves along the bed until deposition at the arroyo terminus. Both the flooding and sediment issues are further worsened when upstream development (commercial or residential) reduces the historic infiltration and produces more runoff.

Because the flooding at the arroyo outlets does not occur within the overbank of a confined channel, the conventional development of a floodplain per routine hydraulic calculations is not feasible. The method used to estimate extent of current property at risk is as follows:

- The volume (in acre-feet) associated with a 100-year storm for the watershed upstream of a proposed basin site was estimated using the hydrologic methods documented in Appendix A.
- The topography downstream of the proposed basin site was reviewed, and a flow path was delineated from the north (upstream per the valley of the Rio) edge of the arroyo outlet to the first linear valley drain (e.g. the Mesa Drain or Mesa Drain Spur).
- A flood area was extended from this flow line downstream along the valley drain until the area encompassed equaled the 100-year flood pool volume from the arroyo, assuming a 1-foot depth of inundation. This area was reviewed for reasonableness. In some cases, based upon the nature of the topography and engineering judgment, the maximum average assumed depth exceeded 1-foot.

The number of buildings (in all cases these were almost exclusively residential) and acres of agricultural lands within the delineated flooded area were counted.

Control of Routine Floods

As noted in Section C.5.0, basins configured for detention allow routine floods (less than the 5-year flood) to proceed downstream. Retention basins, which control these routine floods, have a relative advantage over detention basins in this sense, and this was accounted for in prioritization.

Sediment Control

All of the project basins (detention or retention) contain a sediment pool and provide 5-year protection. Although this improvement does not differentiate between projects, this feature was accounted for in ranking of flood risk reduction.

Current Level of Protection

This issue is used to differentiate between road crossing improvements. An approximate capacity in terms of flood return period was estimated for crossings on existing stormwater conveyance channels.

C.6.1.1.2 Estimation of Real Property Flood Risk Reduction Benefit for Projects with Basins

Given the above information, an index value for Real Property Flood Risk Reduction Benefit was estimated for each project with a basin as the sum of index values for each of the above improvement features:

- Index Value for Residences at Risk. Projects with over 200 residences at risk were assigned an index value of 9; with over 25 residences at risk were assigned an index value of 6, and with any residences at risk were assigned an index value of 3 for this factor. These breakpoints (200, 25) were chosen based upon review of the full distribution of values, and represent the clearest categories of values.
- Index Value for Agricultural Acreage at Risk. Projects with over 400 agricultural acres at risk were assigned an index value of 3; with over 100 agricultural acres at risk were assigned an index value of 2, and with any agricultural acres at risk were assigned an index value of 1 for this factor. Again, these breakpoints (400, 100) were chosen based upon review of the full distribution of values, and represent the clearest categories of values.
- Index Value for Controlling Routine Floods. Projects that control routine floods were given an index value of one for this factor.
- Index Value for Controlling Sediment. Projects that control sediment were given an index value of one for this factor.
- The sum of the above 4 index values is the estimated Real Property Flood Risk Reduction Benefit for each basin project.

This value for each project is shown in Table C-10.

C.6.1.1.3 Estimation of Real Property Flood Risk Reduction Benefit for Projects with Channels

A common method for estimation of Real Property Flood Risk Reduction Benefit for basins and for channels could not be devised because of the difference between types of flooding associated with channels and with basins. The residences counted to be at risk for channel projects are adjacent to existing channels. These residences when flooded are potentially impacted to a significant depth and to a greater degree (due to

the relatively high velocity of overbank flows) than residences impacted by the relatively shallow overland floods generally associated with the arroyo outlet floods.

Given the above information, an index value for Real Property Flood Risk Reduction Benefit was estimated for each project with a channel as the sum of index values for each of the above improvement features:

- Index Value for Residences at Risk. Projects with over 20 residences at risk were assigned an index value of 6; with over 10 residences at risk were assigned an index value of 4. Projects that involved stabilization of existing, adequately sized channel, or procurement of maintenance easements for an existing adequately sized channel were assigned an index value of 2. These breakpoints (20, 10) were chosen based upon review of the full distribution of values, and represent the clearest categories of values.
- Index Value for Controlling Routine Floods. Projects that control routine floods were given an index value of one for this factor.
- The sum of the above 4 index values is the estimated Real Property Flood Risk Reduction Benefit for each channel improvement project.

This value for each project is shown in Table C-10.

C.6.1.1.4 Estimation of Real Property Flood Risk Reduction Benefit for Road Crossing Improvement Projects.

Index values were assigned based upon the estimated existing flood capacity of the culvert/crossing to be improved. Severely undersized road crossings (with capacities less than a 5-year flood) were assigned an index value of three. Road crossings with relatively limited capacities (6-year to 49-year flood) were assigned an index value of 2. Road crossings with significant capacities (50-year flood and greater) were assigned an index value of 1.

This value for each project is shown in Table C-10.

C.6.1.2 Assignment of Flood Risk Reduction Benefit for Arterials

Most of the projects developed reduce the frequency of overtopping of arterials (roads) either by reducing flow into road crossings, reducing sediment load (and associated frequency of culvert blockage), or expanding capacity of the culvert under the road. The process for assigning a flood risk reduction benefit for roads proceeded as follows:

- For each project, roads which would overtop less often after project implementation were identified.
- These roads were divided into two categories: those which have been designated as critical routes, and those which have not. Critical routes were designated based upon whether the relevant road was a major arterial, and whether by map review a road was deemed likely to be a principal route for emergency traffic during a flood.

- A flood risk reduction benefit of two was assigned where critical routes were improved; and a benefit of one was assigned where other roads were improved.

This value for each project is shown in Table C-10.

C.6.1.3 Assignment of Benefit for Maintenance Reduction

Each of the proposed projects involves a maintenance benefit, either by reducing the amount of sediment removal required, by stabilizing channels whose frequent erosion/ sedimentation damage requires repair, by reducing the frequency of culvert blockage, etc. Depending upon the entity currently performing the maintenance, the benefit could accrue to the county, a local municipality (e.g. Socorro, Vinton), or the individual landowner.

The maintenance reduction benefit for each project was estimated qualitatively in a working meeting with public agency participants (El Paso County, EPWU, Vinton, and Socorro). Benefit values from one to five were assigned based upon recent public maintenance experience and input received in the September 2009 public meeting. Experience discussed qualitatively included:

- Frequency of need for maintenance;
- Magnitude of periodic maintenance (e.g. amount of periodic sediment removal); and
- Need for private owner sediment removal at outlet of currently uncontrolled arroyos (this issue was generally assigned a value from 3 to 4).

This value for each project is shown in Table C-10.

C.6.1.4 Assignment of Total Risk Reduction Benefit

The total risk reduction benefit for each project was estimated by adding together the Real Property Flood Risk Reduction Benefit, the Arterial Flood Risk Reduction Benefit, and the Maintenance Benefit. This value for each project is shown in Table C-10.

C.6.2 Assignment of Priority Categories

Table C-11 is the same as Table C-10 sorted 1) by project type (basin, crossing, channel), then 2) by Total Risk Reduction Benefit (in descending order of value). Projects with the highest estimated benefit for each project type were assigned to Priority Category I, and the remainder were divided into Priority Category II or III. The breakpoints between Priority Category were identified by discussion and consensus during the working meeting.

C.6.3 Assignment of Priority Within Category I

In development of large federal projects, it is a common requirement to estimate a direct ratio of project benefit (in dollars) to project costs (in dollars). This estimation, which is

a very detailed, time-consuming process, allows for direct comparison during funding decisions of projects across the United States. This final step in the prioritization process was intended to parallel this process by qualitatively selecting within the list of Priority Category I projects those projects whose benefits (in avoided cost of damages, repairs, and maintenance) would likely exceed the estimated total cost. These qualitative decisions were made in the working meeting by stepping down through the Category I projects one by one and:

- Comparing magnitude of project costs to magnitude of the identified benefits;
- Discussion of rationale ordering of linked projects (e.g. the series of projects along Sparks Arroyo; crossing improvement projects on channels to be improved); and
- Identification of each project as being “High,” “Medium,” or “Low” sub-priority based upon the discussions.

Table C-12 is the same as Table C-11 sorted 1) by Priority Category (I,II,II) and 2) for Category I, by subcategory (High, Medium, Low).

C.6.4 Discussion of Alternatives to 100-Year Level of Protection

Each of the costs in Tables C-10 through C-12 are associated with provision of protection against a 100-year flood (1% annual exceedance probability event). The likely reduction in cost for basin projects associated with provision of lesser protection was estimated per procedures discussed in Appendix C, Section C.3.2.1, with estimated costs provided in Table C-6. Table C-12 provides an alternative cost for larger basin projects for provision of the 25-year flood (4% annual exceedance probability event) protection. These costs are roughly half that of those for provision of 100-year protection.

TABLES

This page was intentionally left blank.

Table C-1. Summary of Significant Cost Factors/Unit Costs

Item	Unit	Unit Cost	Source	Notes
Excavation	CY	\$5.00	TxDOT Bid Tabs-El Paso	Excavation (Special) - Item 110 2003 average was \$4.08 (12 month moving 02/08/2010).
Earthwork	CY	\$5.00	NRCS Bid Tabs and Engineering Judgment	Placing Excavated Fill, Compacting, and Shaping for Embankment.
Embankment Fill	CY	\$23.00	"Draft Unit Cost Summary" Spreadsheet for Active El Paso Drainage Projects	Bringing In Fill, Placing, Compacting, and Shaping for Embankment.
Riprap (18-inch)	CY	\$84.00	TxDOT Bid Tabs-Statewide	Item 432 2021 average was \$83.42 (12 month moving 02/08/2010).
Concrete Box Culverts	CF	\$25.00	Based on Engineering Judgment (Used In City SMP)	\$25 per square foot of opening x LF.
Outlet Works for Basins	LS	\$120,000.00	Capital Improvements Report (July 2008) and Engineering Judgment	Includes Trash Rack, Intake Tower, Impact Basin, etc.
Soil Disposal	CY	\$5.00	EPWU Guidance for City SMP	
Channel Excavation	CY	\$8.00	TxDOT Bid Tabs-El Paso	Excavation (Channel) - Item 110 2002 average was \$8.00 (12 month moving 02/08/2010).
Backfill	CY	\$12.00	TxDOT Bid Tabs-Statewide	Backfill (TY A) - Item 134 2005 average was \$11.13 (12 month moving 02/08/2010).
Cut and Restore Asphalt Road Surface	SY	\$50.00	TxDOT Bid Tabs-Statewide	Item 400 2008 average was \$49.76 (12 month moving 02/08/2010).
Cut and Restore Concrete Road Surface	SY	\$54.00	TxDOT Bid Tabs-Statewide	Item 400 2009 average was \$53.16 (12 month moving 02/08/2010).
Concrete Channel Lining	SY	\$88.00	TxDOT Bid Tabs-Statewide	CL A CONC (Misc) (6") - Item 420 2045 average was \$88.00 (12 month moving 10/2009).
Finish Grading for Earthen Channels	SY	\$3.00	TxDOT Bid Tabs-Statewide	Items 251 2003 - 251 2035 (12 month moving 10/2009) - Based on average cost of rework base material for different soil types at 6-inch ordinary compaction.
RCP Storm Sewer system (48-inch)	LF	\$1,105.00	City of El Paso Bid Tabs	Estimated on a LF Basis from Upper Valley Drainage Improvements Phase III - Bid Phase II.
RCP Storm Sewer System (36-inch)	LF	\$820.00	City of El Paso Bid Tabs	Estimated on a LF Basis from Davis Drive Street and Drainage Improvements.
RCP Storm Sewer System Additional Barrel (48-inch)	LF	\$97.00	TxDOT Bid Tabs-Statewide	RCP (CL III) (48IN) - Item 464 2011 average was \$96.52 (12 month moving 02/2010)
RCP Storm Sewer System Additional Barrel (36-inch)	LF	\$66.00	TxDOT Bid Tabs-Statewide	RCP (CL III) (36IN) - Item 464 2009 average was \$65.74 (12 month moving 02/2010).
Embankment Fill (Clay)	CY	\$25.00	NRCS Bid Tabs and Engineering Judgment	For Dam Embankment.
Coarse Drainfill	CY	\$50.00	NRCS Bid Tabs and Engineering Judgment	For Dam Embankment.
Polyurethane Membrane	SF	\$0.50	NRCS Bid Tabs and Engineering Judgment	For Dam Embankment.
Geotextile	SF	\$0.15	NRCS Bid Tabs and Engineering Judgment	For Dam Embankment.

Table C-2. Summary of Crossing Concept Designs

Project No. & Alternative	Location	Material and Dimensions of Existing Crossing	Dimensions of Proposed Crossing	Type	Length (ft)	Road Surface	ROW/Easement Issues	Utility Relocation	Total Cost	Preferred Alternative	Comments
VINTON											
VIN6_1	Flow Path Number 44 and Doniphan Drive	16' x 5' CBC	3 - 9' x 8'	CBC	70	ASPHALT	NONE	MINOR	\$600,408	VIN6_1	
VIN7_1*	Flow Path Number 45 and Railroad	42' span bridge	84' span bridge		18.5	Railroad	NONE	NONE	\$619,813	VIN7_1*	
VIN8_1*	Flow Path Number 45 and Doniphan Drive	2 - 6' x 6' CBC	56' span bridge		70	ASPHALT	NONE	NONE	\$1,258,908	VIN8_1*	
VIN9_1*	Flow Path Number 45 and AP Ramirez Street	4 - 36" CMP	110' span bridge		40	ASPHALT	NONE	NONE	\$1,409,760	VIN9_1*	
VIN11_1*	Flow Path Number 45 and Kiely Road	2 - 8' x 3' CBC	58' span bridge		42	ASPHALT	NONE	NONE	\$731,165	VIN11_1*	
VIN12_1*	Flow Path Number 45 and Quejette Road	at grade crossing	58' span bridge		40	ASPHALT	NONE	NONE	\$696,348	VIN12_1*	
VIN13_1*	Flow Path Number 45 and IH-10 Northbound Off-ramp	adding to existing structures	3 - 9' x 5'	CBC	39	ASPHALT	NONE	NONE	\$198,977	VIN13_1*	
VIN14_1*	Flow Path Number 45A and Kiely Road	2 - 30" RCP	5 - 7' x 4'	CBC	47	ASPHALT	NONE	NONE	\$256,444	VIN14_1*	
VIN15_1*	Flow Path Number 45A and Iron Drive	3 - 30" RCP	6 - 6' x 6'	CBC	38	ASPHALT	NONE	NONE	\$311,296	VIN15_1*	
CANUTILLO											
CAN3_1	First Avenue Channel and West Avenue	2 - 12" CMP	1 - 6' x 3'	CBC	102	ASPHALT	NONE	NONE	\$69,819	CAN3_1	Must be completed with basin CAN3_1E and CAN3_1C.
CAN4_1	First Avenue Channel and Doniphan Drive	2 - 6' x 3' CBC	2 - 6' x 3'	CBC	89	ASPHALT	NONE	MINOR	\$135,053	CAN4_1	Must be completed with basin CAN3_1C and CAN3_1E.
SPARKS ARROYO AND SUB BASIN A											
SSA5_1	Sparks Arroyo and Stockyard Drive	N/A	6 - 10' x 4'	CBC	60	ASPHALT	NONE	MINOR	\$585,750	SSA5_1	
SSA7_1	Valley Ridge Ditch and Driveway 1	N/A	6 - 5' x 4'	CBC	60	CONCRETE	NONE	NONE	\$268,152	SSA7_1	
SSA7_1	Valley Ridge Ditch and Driveway 2	N/A	6 - 5' x 4'	CBC	40	CONCRETE	NONE	NONE	\$178,768	SSA7_1	
SSA7_1	Valley Ridge Ditch and Driveway 3	N/A	6 - 5' x 4'	CBC	40	CONCRETE	NONE	NONE	\$178,768	SSA7_1	
SSA7_1	Valley Ridge Ditch and Road	N/A	6 - 5' x 4'	CBC	60	ASPHALT	NONE	MINOR	\$293,700	SSA7_1	
SOCORRO											
SOC5_1	Mesa Spur Drain and Carr Road	1 - 48" CMP	2 - 7' x 7'	CBC	50	NONE	NONE	NONE	\$173,375	SOC5_1	
SOC6_1	Mesa Spur Drain and Coker Road	1 - 48" CMP	2 - 7' x 7'	CBC	40	NONE	NONE	NONE	\$138,700	SOC6_1	
SOC7_1	Mesa Spur Drain and Anderson Road	1 - 48" CMP	2 - 7' x 7'	CBC	40	ASPHALT	NONE	MINOR	\$157,850	SOC7_1	Culverts provide greater capacity than required.
SOC8_1	Mesa Spur Drain and Mesa Spur	1 - 60" CMP	2 - 7' x 7'	CBC	65	NONE	NONE	NONE	\$224,868	SOC8_1	
HACIENDA REAL											
HAC8_1	Stream 7 and Bridgeway Drive	5 - 48" CMP	5 - 4' x 4'	CBC	130	ASPHALT	NONE	MINOR	\$457,028	HAC8_1	Requires HAC2_1 or HAC2_2 to be completed in order to meet 100-year discharge.
HAC8_2	Stream 7 and Bridgeway Drive	5 - 48" CMP	6 - 6' x 6'	CBC	130	ASPHALT	NONE	MINOR	\$1,122,264		
HAC10_1	Mesa Drain and Northloop Drive	1 - 60" RCP	3 - 4' x 4'	CBC	65	ASPHALT	NONE	MINOR	\$130,845	HAC10_1	
HAC11_1	Mesa Drain and FM1110	1 - 42" CMP	2 - 7' x 7'	CBC	132	ASPHALT	NONE	MINOR	\$515,823	HAC11_1	
HAC12_1	Mesa Drain and Salatrall Lateral	1 - 36" RCP	2 - 7' x 7'	CBC	128	NONE	NONE	NONE	\$497,235	HAC12_1	
HAC13_1	Mesa Drain and Fenter	1 - 72" CMP	2 - 7' x 7'	CBC	139	ASPHALT	NONE	MINOR	\$547,458	HAC13_1	
HAC14_1	Mesa Drain and dirt crossing 1,000' upstream of Celum Road	1 - 54" CMP	2 - 7' x 7'	CBC	60	DIRT	NONE	NONE	\$227,535	HAC14_1	
HAC15_1	Mesa Drain and Celum Road	1 - 36" CMP	2 - 7' x 7'	CBC	63	ASPHALT	NONE	MINOR	\$246,188	HAC15_1	
TORNILLO											
TOR6_1	Tornillo Handle Channel 2 and OT Smith Road	2 - 36" x 19" Arch	2 - 4' x 2'	CBC	70	ASPHALT	NONE	MINOR	\$49,203	TOR6_1	

* Issues, alternatives and cost identified in the City of EL Paso Stormwater Master Plan (SMP).

Table C-3. Summary of Basin Concept Designs

Project No. & Alternative	Reservoir		Embankment						Principal Spillway			Other	Property Cost	Structure Cost	Total Cost	Preferred Alternative	Comments
	100-Year Flood Pool (acre-feet)	Sediment Pool (acre-feet)	Length (ft)	Max Height (ft)	Volume of Embankment (acre-feet)	Volume of Embankment (CY)	Total Excavated Volume (acre-feet)	Total Excavated Volume (CY)	Type	Dimensions	Length (ft)						
VINTON																	
VIN1_1A*	388.3	134.2	800	24	44.7	72,116	380.2	613,421	RCP	54"	106		N/A		\$13,867,636	VIN1_1A*	
VIN1_1B*	249.4	125.9	875	23	37.2	60,016	200.2	322,989	RCP	54"	102		N/A		\$7,764,761	VIN1_1B*	
VIN5_1 (detention)	466.0	9.0	2,901	19	91.1	146,975	237.5	383,086	CBC	1 - 6' x 6'	250	Clay core, chimney drain, and polyurethane membrane. Riprap interior embankment face. Five feet freeboard for PMP.	\$737,129	\$11,335,629	\$12,072,758		
VIN5_2 (retention)	499.0	9.0	2,901	27	172.6	278,461	237.5	383,086	CBC	1 - 2' x 2'	250	Clay core, chimney drain, and polyurethane membrane. Riprap interior embankment face. Five feet freeboard for PMP.	\$737,129	\$14,774,169	\$15,511,298		
CANUTILLO																	
CAN1_2 (detention)	262.0	5.0	1,260	17	32.5	52,433	39.0	62,920	CBC	1 - 4.5' x 4.5'	250	Clay core, chimney drain, and polyurethane membrane. Riprap interior embankment face. Five feet freeboard for PMP.	\$136,645	\$3,033,744	\$3,170,389		
CAN1_3 (retention)	262.0	5.0	1,260	30	91.1	146,975	39.0	62,920	CBC	1 - 2' x 2'	250	Clay core, chimney drain, and polyurethane membrane. Riprap interior embankment face. Five feet freeboard for PMP.	\$136,645	\$6,833,588	\$6,970,233		
CAN3_1 (Basin 1A)	30.0	0.0	1,225	20	42.2	68,083	9.4	15,085	CBC	1 - 2' x 2'	250	Clay core, chimney drain, and polyurethane membrane. Riprap interior embankment face. Five feet freeboard for PMP.	\$397,973	\$1,837,420	\$2,235,393		
CAN3_1 (Basin 1B)	14.0	0.0	0	0	0.0	0	10.9	17,569	None	None	None		\$0	\$170,320	\$170,320		
CAN3_2 (Basin 1A)	30.0	0.0	1,108	6	5.0	8,131	21.1	34,057	CBC	1 - 2' x 2'	250	Clay core, chimney drain, and polyurethane membrane. Riprap interior embankment face.	\$397,973	\$1,143,157	\$1,541,130	CAN3_2	
CAN3_2 (Basin 1B)	14.0	0.0	0	0	0.0	0	10.9	17,569	None	None	None		\$0	\$170,320	\$170,320	CAN3_2	
SPARKS ARROYO AND SUB BASIN A																	
SSA1_1	1019.2	21.8	3,954	41	305.7	493,212	305.7	493,212	RCP	1 - 2'	250	Clay core, chimney drain, and polyurethane membrane. Riprap interior embankment face. Ten feet freeboard for PMP.	\$148,473	\$22,483,176	\$22,631,649	SSA1_1	
SSA2_1	117.8	2.8	1,837	22	45.7	73,681	45.7	73,681	RCP	1 - 2'	250	Clay core, chimney drain, and polyurethane membrane. Riprap interior embankment face. Six feet freeboard for PMP.	\$215,884	\$4,147,644	\$4,363,528	SSA2_1	
SSA3_1	167.6	3.4	1,511	36	67.2	108,416	67.2	108,416	RCP	1 - 2'	250	Clay core, chimney drain, and polyurethane membrane. Riprap interior embankment face. Seven feet freeboard for PMP.	\$7,131	\$5,453,652	\$5,460,782	SSA3_1	
SSA4_1	626.5	12.0	2,389	37	139.2	224,528	139.2	224,528	RCP	1 - 4'	250	Clay core, chimney drain, and polyurethane membrane. Riprap interior embankment face. Ten feet freeboard for PMP.	\$816,970	\$10,781,583	\$11,598,553	SSA4_1	
SSA6_1 (Location A)	13.3	0.0	0	0	0.0	0	13.3	21,457	None	None	None		\$79,586	\$289,674	\$369,260	SSA6_1	
SSA6_1 (Location B)	8.4	0.0	0	0	0.0	0	8.4	13,552	None	None	None		County Owned	\$182,952	\$182,952	SSA6_1	Actual cost may be less after existing basin capacity is accounted for.
SSA7_1	684.0	NA	2,133	6	8.0	12,891	684.0	1,103,520	CBC	1 - 2' x 2'	250	Clay core, chimney drain, and polyurethane membrane. Riprap interior embankment face.	\$709,168	\$15,627,272	\$16,336,440	SSA7_1	

Table C-3. Summary of Basin Concept Designs (Continued)

Project No. & Alternative	Reservoir		Embankment						Principal Spillway			Other	Property Cost	Structure Cost	Total Cost	Preferred Alternative	Comments
	100-Year Flood Pool (acre-feet)	Sediment Pool (acre-feet)	Length (ft)	Max Height (ft)	Volume of Embankment (acre-feet)	Volume of Embankment (CY)	Total Excavated Volume (acre-feet)	Total Excavated Volume (CY)	Type	Dimensions	Length (ft)						
SOCORRO																	
SOC1_1 (detention)	47.0	4.8	925	15	2.4	3,840	33.0	53,240	CBC	2 - 3' x 3'	250	Five feet freeboard for PMP.	\$8,362	\$1,233,705	\$1,242,067	SOC1_1 (detention)	Existing embankment that breached. Requires embankment repair and excavation.
SOC2_1 (detention with SOC1_1 complete)	107.1	0.8	498	30	17.5	28,169	50.6	81,692	CBC	1 - 2' x 2'	250	Clay core, chimney drain, and polyurethane membrane. Riprap interior embankment face. Five feet freeboard for PMP.	\$101,908	\$2,302,633	\$2,404,541		Requires SOC1 to be completed.
SOC3_1 (detention)	23.0	2.6	307	26	7.9	12,810	7.9	12,810	CBC	1 - 2' x 2'	250	Clay core, chimney drain, and polyurethane membrane. Riprap interior embankment face. Five feet freeboard for PMP.	\$26,537	\$840,305	\$866,842		
SOC4_1 (detention)	31.5	3.5	421	29	9.5	15,327	9.5	15,327	CBC	1 - 2' x 2'	250	Clay core, chimney drain, and polyurethane membrane. Riprap interior embankment face. Five feet freeboard for PMP.	\$178,626	\$998,874	\$1,177,501		
HACIENDA REAL																	
HAC1_1 (detention)	8.0	1.3	0	0	0.0	0	0.0	0	CBC	1 - 2' x 2'	3700	Storm Drain to Stream 7.	\$88,024	\$661,500	\$749,524	HAC1_1 (detention)	Existing basin - no excavation required.
HAC2_1 (Basin A detention)	93.3	1.9	1,819	15	5.4	8,744	5.4	8,744	CBC	1 - 5' x 5'	250	Clay core, chimney drain, and polyurethane membrane. Riprap interior embankment face. Five feet freeboard for PMP.	\$69,170	\$1,441,117	\$1,510,287		
HAC2_1 (Basin B detention)	340.1	11.5	4,070	26	84.7	136,633	84.9	136,633	CBC	1 - 4' x 4'	250	Clay core, chimney drain, and polyurethane membrane. Riprap interior embankment face. Five feet freeboard for PMP.	\$42,654	\$7,968,645	\$8,011,299		
HAC2_2 (Basin A retention)	110.8	1.9	1,912	16	5.5	8,793	5.5	8,793	CBC	1 - 2' x 2'	250	Clay core, chimney drain, and polyurethane membrane. Riprap interior embankment face. Five feet freeboard for PMP.	\$69,170	\$1,298,318	\$1,367,488	HAC2_2	
HAC2_2 (Basin B retention)	476.2	11.5	4,372	28	101.0	162,914	101.0	162,914	CBC	1 - 2' x 2'	250	Clay core, chimney drain, and polyurethane membrane. Riprap interior embankment face. Five feet freeboard for PMP.	\$42,654	\$9,158,159	\$9,200,813	HAC2_2	
HAC3_1 (detention)	41.3	2.5	1,547	13	14.5	23,458	14.5	23,458	CBC	1 - 2' x 2'	250	Clay core, chimney drain, and polyurethane membrane. Riprap interior embankment face. Five feet freeboard for PMP.	\$27,833	\$1,845,883	\$1,873,717		
HAC3_2 (retention)	66.1	2.5	1,200	6	2.5	4,066	64.0	103,253	CBC	1 - 2' x 2'	250	Clay core, chimney drain, and polyurethane membrane. Riprap interior embankment face.	\$27,833	\$2,136,561	\$2,164,394	HAC3_2	
HAC4_1 (detention)	8.8	2.1	1,322	11	8.9	14,407	8.9	14,407	CBC	1 - 2' x 2'	250	Clay core, chimney drain, and polyurethane membrane. Riprap interior embankment face. Five feet freeboard for PMP.	\$40,680	\$1,345,473	\$1,386,152		
HAC4_2 (retention)	27.0	2.1	1,105	6	2.2	3,565	36.0	58,080	CBC	1 - 2' x 2'	250	Clay core, chimney drain, and polyurethane membrane. Riprap interior embankment face.	\$40,680	\$1,472,582	\$1,513,262	HAC4_2	
HAC5_1 (detention)	28.7	1.8	1,695	13	19.9	32,138	19.9	32,138	CBC	1 - 2' x 2'	250	Clay core, chimney drain, and polyurethane membrane. Riprap interior embankment face. Five feet freeboard for PMP.	\$13,913	\$2,308,121	\$2,322,034		
HAC5_2 (retention)	49.0	1.8	1,355	6	5.8	9,293	61.0	98,413	CBC	1 - 2' x 2'	250	Clay core, chimney drain, and polyurethane membrane. Riprap interior embankment face.	\$13,913	\$2,322,624	\$2,336,537	HAC5_2	

Table C-3. Summary of Basin Concept Designs (Continued)

Project No. & Alternative	Reservoir		Embankment						Principal Spillway			Other	Property Cost	Structure Cost	Total Cost	Preferred Alternative	Comments
	100-Year Flood Pool (acre-feet)	Sediment Pool (acre-feet)	Length (ft)	Max Height (ft)	Volume of Embankment (acre-feet)	Volume of Embankment (CY)	Total Excavated Volume (acre-feet)	Total Excavated Volume (CY)	Type	Dimensions	Length (ft)						
HACIENDA REAL (Continued)																	
HAC6_1 (detention)	65.8	4.2	1,956	18	31.2	50,304	31.2	50,304	CBC	1 - 2' x 2'	250	Clay core, chimney drain, and polyurethane membrane. Riprap interior embankment face. Five feet freeboard for PMP.	\$4,142	\$3,204,952	\$3,209,093		
HAC6_2 (retention)	100.1	4.2	1,350	6	2.2	3,501	127.0	204,893	CBC	1 - 2' x 2'	250	Clay core, chimney drain, and polyurethane membrane. Riprap interior embankment face.	\$4,142	\$3,541,609	\$3,545,751	HAC6_2	
HAC7_1 (Basin A detention)	6.2	2.7	888	6	2.2	3,501	2.7	4,308	CBC	2 - 4' x 4'	250	Clay core, chimney drain, and polyurethane membrane. Riprap interior embankment face.	\$4,428	\$909,438	\$913,865	HAC7_1	
HAC7_1 (Basin B detention)	278.3	12.8	2,557	6	6.6	10,600	12.8	20,570	CBC	1 - 2' x 2'	250	Clay core, chimney drain, and polyurethane membrane. Riprap interior embankment face.	\$28,234	\$1,764,752	\$1,792,986	HAC7_1	
HAC7_2 (Basin A det/ret)	33.9	2.7	1,274	15	17.6	28,362	17.6	28,362	CBC	1 - 2' x 2'	250	Clay core, chimney drain, and polyurethane membrane. Riprap interior embankment face. Five feet freeboard for PMP.	\$4,428	\$1,953,986	\$1,958,414		
HAC7_2 (Basin B det/ret)	278.3	12.8	2,557	6	6.6	10,600	12.8	20,570	CBC	1 - 2' x 2'	250	Clay core, chimney drain, and polyurethane membrane. Riprap interior embankment face.	\$28,234	\$1,764,752	\$1,792,986		
FABENS																	
FAB1_1	44.0	4.0	1,197	15	24.7	39,849	27.4	44,189	CBC	1 - 2' x 2'	250	Clay core, chimney drain, and polyurethane membrane. Riprap interior embankment face. Five feet freeboard for PMP.	\$18,847	\$2,521,197	\$2,540,044	FAB1_1	
FAB3_1	NA	NA	NA	NA	NA	NA	NA	NA	None	None	None	Add 1,165 feet of 4-foot high parapet wall and widen east auxiliary spillway to 150 feet.	\$0	\$1,338,060	\$1,338,060	FAB3_1	Upgrade Fabens Dam.
TORNILLO																	
TOR1_1 (Basin TOR1_1A)	0.0	2.0	0	0	0.0	0	4.3	6,873	None	None	None		\$379	\$92,783	\$93,162		Sediment Basin only.
TOR1_1 (Basin TOR1_1 & TOR3_1)	74.0	3.0	2,144	14	39.3	63,404	12.0	19,360	CBC	1 - 2' x 2'	250	Clay core, chimney drain, and polyurethane membrane. Riprap interior embankment face. Five feet freeboard for PMP.	\$5,606	\$3,479,255	\$3,484,861		
TOR1_2 (Basin TOR1_1A)	0.0	2.0	0	0	0.0	0	4.26	6,873	None	None	None		\$379	\$92,783	\$93,162	TOR1_2	Sediment Basin only.
TOR1_2 (Basin TOR1_1 & TOR3_1)	74.0	3.0	1,734	6	7.9	12,745	12.00	19,360	CBC	1 - 2' x 2'	250	Clay core, chimney drain, and polyurethane membrane. Riprap interior embankment face.	\$5,606	\$2,328,799	\$2,334,405	TOR1_2	
TOR3_1 (Basin TOR3_1A)	0.0	1.0	0	0	0.0	0	2.02	3,259	None	None	None		\$7,554	\$43,995	\$51,549	TOR3_1	Sediment Basin only.
TOR4_1 (Basin TOR4_1 & TOR5_1)	15.0	1.0	1,100	10	11.4	18,392	6.87	11,084	CBC	1 - 2' x 2'	250	Clay core, chimney drain, and polyurethane membrane. Riprap interior embankment face. Five feet freeboard for PMP.	\$1,218	\$1,339,658	\$1,340,876	TOR4_1	

* Issues, alternatives and cost identified in the City of EL Paso Stormwater Master Plan (SMP).

Table C-4. Summary of Storm Drain Concept Designs

Project No. & Alternative	Location	Existing Structure Dimensions	Proposed Dimensions	Type	Length (ft)	Total Cost	Preferred Alternative	Comments
CANUTILLO								
CAN3_1	East of Third Street and Joe Angel Avenue from proposed basin CAN3_1A to existing basin CAN3_1B	N/A	1 - 48"	RCP	1,665	\$2,483,764	CAN3_1	

This page was intentionally left blank.

Table C-5. Summary of Channel Concept Designs

Project No. & Alternative	Location	Existing Channel Material and Dimensions (ft) ¹	Proposed Channel Material	Proposed Bottom Width (ft)	Proposed Depth (ft)	Side Slopes (hor:1)	Length of Improvements (ft)	Property Cost	Total Cost	Preferred Alternative	Comments
VINTON											
VIN1_1*	Flow Path Number 45A, east of and parallel to Remington Drive from Flow Path Number 45A to Flow Path Number 45	No existing channel	Earthen	10	3	2	2,240	\$54,573	\$179,565	VIN1_1*	
VIN2_1*	Lower portion of Flow Path Number 45A from 240 feet upstream of Iron Drive to 260 feet downstream of Kiely Road	Earthen channel, various dimensions	Earthen	15	5	2	950	\$164,700	\$241,234	VIN2_1*	
VIN3_1*	Flow Path Number 45, between Tom Mays Drive and De Alva Drive	Earthen channel, various dimensions	Earthen	30	3	2	1,600	N/A	\$120,359	VIN3_1*	
VIN4_1*	Flow Path Number 45, between IH-10 Southbound on-ramp and the confluence of Flow Path Number 45A	Earthen channel, various dimensions	Earthen	20	9.5	2	4,500	N/A	\$859,949	VIN4_1*	
VIN5_1	Flow Path Number 44, between conversion of Flow Path Number 43 and Doniphan Drive	Earthen channel, various dimensions	Earthen	25	6	3	2,054	\$698,329	\$856,746	VIN5_1	
CANUTILLO											
CAN1_1	Flow Path Number 42 between El Chanate Drive and Doniphan Drive	Earthen channel, various dimensions	Concrete	30	5	2	1,238	\$533,548	\$1,436,292	CAN1_1	
CAN3_1	First Avenue Channel between store entrance from Doniphan Drive to culvert under Doniphan Drive	No existing channel	Concrete	4	3	2	143	N/A	\$36,210	CAN3_1	
SPARKS ARROYO AND SUB BASIN A											
SSA3_1	1,100 feet upstream of proposed A5-A6 Basin along A5 Arroyo	Earthen channel, various dimensions	Concrete	20	3	3	1,053	\$0	\$710,300	SSA3_1	
SSA5_1	Sparks Arroyo between proposed Sparks Basin and proposed Valley Ridge Basin	Earthen channel, various dimensions	Concrete	25	5	3	10,329	\$0	\$8,100,099	SSA5_1	
SSA6_1 (Location A)	Parallel to the Sparks Arroyo from the intersection of Notre Dame Lane and Upsala Drive to the intersection of Notre Dame Lane and Bowdoin Drive	No existing channel	Concrete	10	3	3	980	\$0	\$457,164	SSA6_1	
SSA6_1 (Location A)	Parallel to the Sparks Arroyo from the intersection of Notre Dame Lane and Bryn Mawr Court to the intersection of Notre Dame Lane and Bowdoin Drive	No existing channel	Concrete	10	3	3	250	\$0	\$116,623	SSA6_1	
SSA6_1 (Location B)	Parallel to Berkley from 940 feet north of Sparks Drive to Sparks Drive	No existing channel	Concrete	10	3	3	940	\$0	\$597,960	SSA6_1	
SSA6_1 (Location B)	From the intersection of Grand River Drive and Notre Dame Lane to the proposed pond near the intersection of Notre Dame Lane and Sparks Drive	No existing channel	Concrete	10	3	3	390	\$0	\$181,933	SSA6_1	
SSA7_1	Northwest along Stockyard Drive from Jaime Street past Sparks Arroyo	N/A	Concrete	10	5	2	3,474	\$1,180,331	\$3,046,162	SSA7_1	
FABENS											
FAB2_1	San Felipe Arroyo between IH-10 to channel outlet	N/A	N/A	N/A	N/A	N/A	N/A	\$500,643	\$500,643	FAB2_1	No current capacity issues with the channel, acquire property to maintain channel capacity.
TORNILLO											
TOR2_1	High School Channel from 2,490' US of confluence with South High School Channel to 448' US of confluence	Earthen channel with tire riprap west embankment	Reinforcing Riprap Embankment	No Change	No Change	5	2,032	\$2,336	\$806,048	TOR2_1	Improvements to the channels west bank only.
TOR5_1	Tornillo Handle Channel 11,652' US of confluence with Tornillo Handle Channel 2 to the confluence	Earthen channel	Reinforcing Riprap Embankment	No Change	No Change	3	1,652	\$1,003	\$209,234	TOR5_1	Improvements to the channels south bank only.

* Issues, alternatives and cost identified in the City of EL Paso Stormwater Master Plan (SMP).

Table C-6. Alternative Costing Table

Project No & Alternative	Issue to be Addressed	Description of Alternative	Component			Total Cost	Total Cost (Rounded to \$10,000)				Preferred Alternatives
			Description	Cost (No Contingency)	Cost		100-Year Protection	50-Year Basin Protection (81%)	25-Year Basin Protection (55%)	10-Year Basin Protection (45%)	
VINTON											
Flow Path Number 45A and Flow Path Number 45											
VIN1_1*	Flooding along channel due to uncontrolled flows from Flow Path Number 45A and Flow Path Number 45.	This alternative involves constructing a diversion channel upstream of Remington Drive directing the flow to Flow Path Number 45, and two combination sediment/detention basins. One basin on the north portion of the upper watershed (VIN1_1A) and the other on the south portion of the upper watershed (VIN1_1B). VIN1_1A will be 24 feet high. Approximately 380 acre-feet of excavation will be required for flood and sediment pool storage. A culvert principal outlet and an earthen auxiliary spillway will be included in the design. VIN1_1B will be 23 feet high. Approximately 200 acre-feet of excavation will be required for flood and sediment pool storage. A culvert principal outlet and an earthen auxiliary spillway will be included in the design.	Sediment/Detention Basin (VIN1_1A) - property acquisition not included	\$10,272,323	\$13,867,636	\$21,811,963	\$21,810,000	\$17,700,000	\$12,080,000	\$9,910,000	X
			Sediment/Detention Basin (VIN1_1B) - property acquisition not included	\$5,751,675	\$7,764,761						
			2,240' of Channel Improvements	\$92,587	\$124,992						
			Property (For Channel Acquisition)	\$54,573	\$54,573						
VIN2_1*	Area flooding due to uncontrolled flows from Flow Path Number 45A.	This alternative involves increasing 950 feet of the lower portion of Flow Path Number 45A channel capacity from 240 feet upstream of Iron Drive to 260 feet downstream of Kiely Road.	950' of Channel Improvements	\$56,692	\$76,534	\$241,234	\$240,000	N/A	N/A	N/A	X
			Property (For Channel Acquisition)	\$164,700	\$164,700						
VIN3_1*	Area flooding due to uncontrolled flows from Flow Path Number 45.	This alternative involves increasing 1,600 feet of the upper portion of Flow Path Number 45 channel capacity to convey the outflow of the basins associated with VIN1_1*. Basins VIN1_1A and VIN1_1B will be constructed as part of VIN3_1* ONLY if VIN1_1* does not construct the basins. Please refer to VIN1_1* for cost breakdown of proposed basins.	1,600' of Channel Improvements	\$89,155	\$120,359	\$120,359	\$120,000	N/A	N/A	N/A	X
VIN4_1*	Area flooding due to uncontrolled flows from Flow Path Number 45.	This alternative involves increasing 4,500 feet of the middle portion of Flow Path Number 45 channel capacity to convey the outflow of the basins associated with VIN1_1*.	4,500' of Channel Improvements - property acquisition not included	\$636,999	\$859,949	\$859,949	\$860,000	N/A	N/A	N/A	X
VIN7_1*	Crossing capacity at Railroad and Flow Path Number 45 is less than the necessary capacity.	This alternative involves expanding the existing bridge to cross the improved channel. This will provide sufficient capacity equal to the channel improvements.	84' span bridge	\$459,121	\$619,813	\$619,813	\$620,000	N/A	N/A	N/A	X
VIN8_1*	Crossing capacity at Doniphan Drive and Flow Path Number 45 is less than the necessary capacity.	This alternative involves removing the existing two 6-foot by 6-foot culverts and replacing it with a bridge. This will provide sufficient capacity equal to the upstream channel.	56' span bridge	\$932,524	\$1,258,907	\$1,258,907	\$1,260,000	N/A	N/A	N/A	X
VIN9_1*	Crossing capacity at AP Ramirez and Flow Path Number 45 is less than the necessary capacity.	This alternative involves removing the existing four 36-inch culverts and replacing it with a bridge. This will provide sufficient capacity equal to the upstream channel.	110' span bridge	\$1,044,267	\$1,409,760	\$1,409,760	\$1,410,000	N/A	N/A	N/A	X
VIN11_1*	Crossing capacity at Kiely Road and Flow Path Number 45 is less than the necessary capacity.	This alternative involves removing the existing two 8-foot by 3-foot culverts and replacing it with a bridge. This will provide sufficient capacity equal to the upstream channel.	58' span bridge	\$541,604	\$731,165	\$731,165	\$730,000	N/A	N/A	N/A	X
VIN12_1*	Crossing capacity at Quejette Drive and Flow Path Number 45 is less than the necessary capacity.	This alternative involves removing the at grade crossing and replacing it with a bridge. This will provide sufficient capacity equal to the upstream channel.	58' span bridge	\$515,813	\$696,348	\$696,348	\$700,000	N/A	N/A	N/A	X
VIN13_1*	Crossing capacity at IH-10 Northbound off-ramp and Flow Path Number 45 is less than the necessary capacity.	This alternative involves adding three more 9-foot by 5-foot culverts to the existing battery of culverts. This addition of culverts provides sufficient capacity equal to the upstream channel.	3 - 9' x 5' CBC	\$147,390	\$198,977	\$198,977	\$200,000	N/A	N/A	N/A	X
VIN14_1*	Crossing capacity at Kiely Road and Flow Path Number 45A is less than the necessary capacity.	This alternative involves removing the existing two 30-inch round concrete pipes and replacing it with five 7-foot by 4-foot culverts. This culvert size provides sufficient capacity equal to the upstream channel.	5 - 7' x 4' CBC	\$189,958	\$256,443	\$256,443	\$260,000	N/A	N/A	N/A	X
VIN15_1*	Crossing capacity at Iron Drive and Flow Path Number 45A is less than the necessary capacity.	This alternative involves removing the existing three 30-inch round concrete pipes and replacing them with six 6-foot by 6-foot culverts. This culvert size provides sufficient capacity equal to the upstream channel.	6 - 6' x 6' CBC	\$230,590	\$311,297	\$311,297	\$310,000	N/A	N/A	N/A	X

Table C-6. Alternative Costing Table (Continued)

Project No & Alternative	Issue to be Addressed	Description of Alternative	Component			Total Cost	Total Cost (Rounded to \$10,000)				Preferred Alternatives
			Description	Cost (No Contingency)	Cost		100-Year Protection	50-Year Basin Protection (81%)	25-Year Basin Protection (55%)	10-Year Basin Protection (45%)	
VINTON (Continued)											
Flow Path Number 44											
VIN5_1	Downstream flooding due to uncontrolled flows from Flow Path Number 44.	This alternative involves increasing 2,054 feet of Flow Path Number 44 channel capacity to convey the 100-year flood.	2,054' of Channel Improvements	\$117,346	\$158,417	\$860,000	\$860,000	N/A	N/A	N/A	X
			Property	\$698,329	\$698,329						
VIN5_2 (detention)	Downstream flooding and sediment load due to uncontrolled flows from Flow Path Number 44, Flow Path Number 43 and lack of maintenance of channel due to ROW issues.	This alternative involves constructing a combination sediment/detention basin at the confluence of Flow Path Number 43 with Flow Path Number 44 (VIN5). VIN5 will be 19 feet high and will have a clay core, a polyurethane liner, a chimney drain, and will have 18-inch riprap on the interior face. Embankment height includes 5 feet of freeboard for PMP event. Approximately 238 acre-feet of excavation will be required for flood and sediment pool storage, of which a portion will be covered with a clay blanket. A box culvert principal outlet and an earthen auxiliary spillway will be included in the design. Additionally the land downstream of the proposed basin must be obtained to maintain the channel for the outflow of VIN5.	Sediment/Detention Basin (VIN5_2)	\$8,396,762	\$11,335,629	\$12,771,087	\$12,770,000	\$10,480,000	\$7,340,000	\$6,130,000	
			Property at Location VIN5	\$737,129	\$737,129						
			Property to maintain Channel (VIN5_1)	\$698,329	\$698,329						
VIN5_3 (retention)		This alternative involves constructing a combination sediment/retention basin at the confluence of Flow Path Number 43 with Flow Path Number 44 (VIN5). VIN5 will be 27 feet high and will have a clay core, a polyurethane liner, a chimney drain, and will have 18-inch riprap on the interior face. Embankment height includes 5 feet of freeboard for PMP event. Approximately 238 acre-feet of excavation will be required for flood and sediment pool storage, of which a portion will be covered with a clay blanket. A box culvert principal outlet and an earthen auxiliary spillway will be included in the design. Additionally the land downstream of the proposed basin must be obtained to maintain the channel for the outflow of VIN5.	Sediment/Retention Basin (VIN5_3)	\$10,943,829	\$14,774,169	\$16,209,627	\$16,210,000	\$13,260,000	\$9,230,000	\$7,680,000	
			Property at Location VIN5	\$737,129	\$737,129						
			Property to maintain Channel (VIN5_1)	\$698,329	\$698,329						
VIN6_1	Crossing capacity at Doniphan Drive and Flow Path Number 44 is less than the necessary capacity.	This alternative involves removing the existing 16-foot by 5-foot culvert and replacing it with three 9-foot by 8-foot culverts. This culvert size provides sufficient capacity equal to the upstream channel.	3 - 9' x 8' CBC	\$444,746	\$600,407	\$600,407	\$600,000	N/A	N/A	N/A	X
CANUTILLO											
Flow Path Number 42											
CAN1_1	Downstream flooding and sediment load due to uncontrolled flows from Flow Path Number 42 and lack of maintenance of channel due to ROW issues.	This alternative involves reconstructing the channel to convey the 100-year flood, with a concrete lining. Additionally, properties that extend into the channel will need to be acquired.	Reconstruction of the channel with concrete lining	\$668,699	\$902,744	\$1,436,292	\$1,440,000	N/A	N/A	N/A	X
			Property	\$533,548	\$533,548						
CAN1_2		This alternative involves constructing a combination sediment/detention basin on Flow Path Number 42, in the lower portion of watershed FPN42_3. Basin CAN1_2 will be 17 feet high and will have a clay core, a polyurethane liner, a chimney drain, and will have 18-inch riprap on the interior face. Embankment height includes 5 feet of freeboard for PMP event. Approximately 39 acre-feet of excavation will be required for flood and sediment pool storage, of which a portion will be covered with a clay blanket. A box culvert principal outlet and an earthen auxiliary spillway will be included in the design. Additionally the section of the channel located between IH-10 and Los Mochis Avenue is currently vacant land, which the county needs to limit future development around the channel as necessary.	Sediment/Detention Basin (CAN1_2)	\$2,247,218	\$3,033,744	\$3,703,937	\$3,700,000	\$3,100,000	\$2,280,000	\$1,960,000	
			Property at Location CAN1_2	\$136,645	\$136,645						
			Property to maintain Channel (CAN1_1)	\$533,548	\$533,548						
CAN1_3		This alternative involves constructing a combination sediment/retention basin on Flow Path Number 42, in the lower portion of watershed FPN42_3. Basin CAN1_3 will be 30 feet high and will have a clay core, a polyurethane liner, a chimney drain, and will have 18-inch riprap on the interior face. Embankment height includes 5 feet of freeboard for PMP event. Approximately 39 acre-feet of excavation will be required for flood and sediment pool storage, of which a portion will be covered with a clay blanket. A box culvert principal outlet and an earthen auxiliary spillway will be included in the design. Additionally the section of the channel located between IH-10 and Los Mochis Avenue is currently vacant land, which the county needs to limit future development around the channel as necessary.	Sediment/Retention Basin (CAN1_3)	\$5,061,917	\$6,833,588	\$7,503,781	\$7,500,000	\$6,180,000	\$4,370,000	\$3,670,000	
			Property at Location CAN1_3	\$136,645	\$136,645						
			Property to maintain Channel (CAN1_1)	\$533,548	\$533,548						

Table C-6. Alternative Costing Table (Continued)

Project No & Alternative	Issue to be Addressed	Description of Alternative	Component			Total Cost	Total Cost (Rounded to \$10,000)				Preferred Alternatives
			Description	Cost (No Contingency)	Cost		100-Year Protection	50-Year Basin Protection (81%)	25-Year Basin Protection (55%)	10-Year Basin Protection (45%)	
CANUTILLO (Continued)											
First Avenue Channel											
CAN3_1	Localized flooding due to lack of flood control structures.	This alternative involves constructing two retention basins and utilizing an existing basin. One of the constructed basins will be located at the downstream end of First Avenue Channel (CAN3_1B), and the other in a vacant area east of the intersection of West Avenue and Third Avenue (CAN3_2A). Additionally, improvements will be made to First Avenue Channel. CAN3_1B will not require an embankment. Approximately 11 acre-feet of excavation will be required for flood pool storage. CAN3_1A will be 20 feet high and will have a clay core, a polyurethane liner, a chimney drain, and will have 18-inch riprap on the interior face. Embankment height includes 5 feet of freeboard for PMP event. Approximately 9 acre-feet of excavation will be required for flood pool storage, of which a portion will be covered with a clay blanket. A low flow principal spillway will be included to convey flow as CAN3_1A reaches capacity to the existing basin.	Retention Basins (CAN3_1B)	\$170,320	\$229,932	\$5,055,188	\$5,060,000	\$4,590,000	\$3,950,000	\$3,700,000	
			1 - 6' x 3' CBC	\$51,718	\$69,819						
			143' Channel Improvements	\$26,822	\$36,210						
			Retention Basin (CAN3_1A)	\$1,361,052	\$1,837,420						
			Property	\$397,973	\$397,973						
CAN3_2		This alternative involves constructing two retention basins and utilizing an existing basin. One of the constructed basins will be located at the downstream end of First Avenue Channel (CAN3_1B), and the other in a vacant area east of the intersection of West Avenue and Third Avenue (CAN3_2A). Additionally, improvements will be made to First Avenue Channel. CAN3_1B will not require an embankment. Approximately 11 acre-feet of excavation will be required for flood pool storage. CAN3_2A will be 6 feet high and will have a clay core, a polyurethane liner, a chimney drain, and will have 18-inch riprap on the interior face. Approximately 21 acre-feet of excavation will be required for flood pool storage, of which a portion will be covered with a clay blanket. A low flow principal spillway will be included to convey flow as CAN3_2A reaches capacity to the existing basin.	Retention Basins (CAN3_1B)	\$170,320	\$229,932	\$4,360,855	\$4,360,000	\$4,020,000	\$3,560,000	\$3,390,000	X
			1 - 6' x 3' CBC	\$51,718	\$69,819						
			143' Channel Improvements	\$26,822	\$36,210						
			Retention Basin (CAN3_1A)	\$846,783	\$1,143,157						
			Property	\$397,973	\$397,973						
CAN4_1	Crossing capacity at Doniphan Drive and First Avenue Channel is less than the necessary capacity.	This alternative involves removing the existing two 6-foot by 3-foot culvert and replacing it with the same size culvert, ensuring the culvert in sloping in the correct direction to drain. This culvert size provides sufficient capacity provided that additional storage is provided upstream per CAN3_1.	2 - 6' x 3' CBC	\$100,039	\$135,053	\$135,053	\$140,000	N/A	N/A	N/A	X
SPARKS ARROYO AND SUB BASIN A											
SUB BASIN A											
SSA1_1	Uncontrolled flows from Arroyos A1, A2, and A3 are causing flooding problems in downstream communities.	This alternative involves constructing a detention basin that will capture flow from Arroyos A1, A2, and A3. The basin will be 41 feet high and will have a clay core, a polyurethane liner, a chimney drain, and will have 18-inch riprap on the interior face. Embankment height includes 10 feet of freeboard for PMP event. Approximately 306 acre-feet of excavation will be required for flood pool storage, of which a portion will be covered with a clay blanket. Approximately 1,041 acre-feet of flood and sediment pool storage will be provided by this basin.	Sediment/Detention Basin	\$16,654,204	\$22,483,176	\$22,631,649	\$22,630,000	\$18,330,000	\$12,450,000	\$10,180,000	X
			Property	\$148,473	\$148,473						
SSA2_1	Uncontrolled flows from Arroyo A4 are causing flooding problems in downstream communities.	This alternative involves constructing a detention basin that will capture flow from Arroyo A4. The basin will be 22 feet high and will have a clay core, a polyurethane liner, a chimney drain, and will have 18-inch riprap on the interior face. Embankment height includes 6 feet of freeboard for PMP event. Approximately 46 acre-feet of excavation will be required for flood pool storage, of which a portion will be covered with a clay blanket. Approximately 121 acre-feet of flood and sediment pool storage will be provided by this basin.	Sediment/Detention Basin	\$3,072,329	\$4,147,644	\$4,363,528	\$4,360,000	\$3,530,000	\$2,400,000	\$1,960,000	X
			Property	\$215,884	\$215,884						

Table C-6. Alternative Costing Table (Continued)

Project No & Alternative	Issue to be Addressed	Description of Alternative	Component			Total Cost	Total Cost (Rounded to \$10,000)				Preferred Alternatives
			Description	Cost (No Contingency)	Cost		100-Year Protection	50-Year Basin Protection (81%)	25-Year Basin Protection (55%)	10-Year Basin Protection (45%)	
SPARKS ARROYO AND SUB BASIN A (Continued)											
SUB BASIN A (Continued)											
SSA3_1	Uncontrolled flows from Arroyos A5 and A6 are causing flooding problems in downstream communities.	This alternative involves constructing a detention basin that will capture flow from Arroyos A5 and A6. The basin will be 36 feet high and will have a clay core, a polyurethane liner, a chimney drain, and will have 18-inch riprap on the interior face. Embankment height includes 7 feet of freeboard for PMP event. Approximately 67 acre-feet of excavation will be required for flood pool storage, of which a portion will be covered with a clay blanket. Approximately 171 acre-feet of flood and sediment pool storage will be provided by this basin. 1,100 feet of Arroyo A5 will be reshaped and lined to divert flow to the basin as part of this improvement.	Sediment/Retention Basin	\$4,039,742	\$5,453,652	\$6,171,082	\$6,170,000	\$5,130,000	\$3,710,000	\$3,170,000	X
			Property	\$7,131	\$7,131						
			Concrete Lined Channel	\$526,148	\$710,300						
Sparks											
SSA4_1	Flows entering the Sparks Arroyo from the upstream mesa are creating capacity issues for the arroyo and flooding problems downstream.	This alternative involves constructing a detention basin that will capture flow from the mesa above Sparks Arroyo. The basin will be 37 feet high and will have a clay core, a polyurethane liner, a chimney drain, and will have 18-inch riprap on the interior face. Embankment height includes 10 feet of freeboard for PMP event. Approximately 139 acre-feet of excavation will be required for flood pool storage, of which a portion will be covered with a clay blanket. Approximately 639 acre-feet of flood and sediment pool storage will be provided by this basin.	Sediment/Retention Basin	\$7,986,358	\$10,781,583	\$11,598,553	\$11,600,000	\$9,390,000	\$6,380,000	\$5,220,000	X
			Property	\$816,970	\$816,970						
SSA5_1	The Sparks Arroyo is currently experiencing erosion along its banks.	This alternative involves defining the Sparks Arroyo and lining it with concrete to prevent further erosion and add capacity. Approximately 10,300 feet of channel improvements. In addition, a crossing will need to be constructed under Stockyard Drive.	Concrete Lined Channel	\$6,000,074	\$8,100,100	\$8,685,850	\$8,690,000	\$7,040,000	\$4,780,000	\$3,910,000	X
			6 - 10' x 4' CBC	\$433,889	\$585,750						
SSA6_1	Runoff from the Sparks Community is contributing to flooding problems downstream of the Sparks Arroyo.	This project involves constructing two retention basins within the Sparks Community west of the Sparks Arroyo. The north basin will need to be excavated to a volume of approximately 8 acre-feet and will have a 940-foot long concrete lined channel diverting water to it from the north and a 390-foot concrete lined channel from the south. The south basin will need to be excavated to a volume of approximately 13 acre-feet and will have a 980-foot long concrete lined channel diverting water to it from the north and a 250-foot concrete lined channel from the south.	Retention Basin at Location A	\$214,573	\$289,674	\$1,905,892	\$1,910,000	\$1,800,000	\$1,660,000	\$1,600,000	X
			Property for Retention Basin	\$79,586	\$79,586						
			Concrete Lined Channel (N)	\$338,640	\$457,164						
			Concrete Lined Channel (S)	\$86,388	\$116,623						
			Retention Basin at Location B	\$135,520	\$182,952						
			Concrete Lined Channel (N)	\$442,934	\$597,960						
			Concrete Lined Channel (S)	\$134,765	\$181,933						
SSA7_1	Uncontrolled flows from the Sparks Arroyo are causing flooding problems in downstream communities.	This alternative involves constructing a 684 acre-foot retention basin south of Stockyard Drive, at the mouth of the Sparks Arroyo. The basin will be approximately 54 feet deep and will have a 6-foot embankment that will have a clay core, a polyurethane liner, a chimney drain, and will have 18-inch riprap on the interior face. In addition, the existing channel along Stockyard Drive will be expanded, lined with concrete, and redirected to the proposed Valley Ridge Basin. The entire length of the channel improvements is 3,500 feet. The three existing crossings along this channel will need to be installed and one new crossing will need to be constructed.	Sediment/Retention Basin	\$11,575,757	\$15,627,272	\$20,301,991	\$20,300,000	\$17,200,000	\$12,950,000	\$11,320,000	X
			Property	\$709,168	\$709,168						
			Concrete Lined Channel	\$1,382,097	\$1,865,831						
			Property for Channel	\$1,180,331	\$1,180,331						
			6 - 5' x 4' CBC	\$198,631	\$268,152						
			6 - 5' x 4' CBC	\$132,421	\$178,768						
			6 - 5' x 4' CBC	\$132,421	\$178,768						
			6 - 5' x 4' CBC	\$217,556	\$293,701						
SOCORRO											
Stream 4											
SOC1_1	Downstream flooding and sediment load due to uncontrolled flows from Stream 4 passing through the breached El Paso Hills Dam.	This alternative involves repairing the existing 15-foot-high embankment, adding 18-inch riprap to the interior embankment, adding principal and auxiliary spillways, and excavating approximately 33 acre-feet from the basin to provide flood and sediment pool storage.	Repair and Improve existing basin	\$913,855	\$1,233,705	\$1,242,067	\$1,240,000	\$760,000	\$470,000	\$210,000	X
			Property	\$8,362	\$8,362						

Table C-6. Alternative Costing Table (Continued)

Project No & Alternative	Issue to be Addressed	Description of Alternative	Component			Total Cost	Total Cost (Rounded to \$10,000)				Preferred Alternatives
			Description	Cost (No Contingency)	Cost		100-Year Protection	50-Year Basin Protection (81%)	25-Year Basin Protection (55%)	10-Year Basin Protection (45%)	
SOCORRO (Continued)											
Stream 4 (Continued)											
SOC2_1	Downstream flooding and sediment load due to uncontrolled flows from Stream 4.	This alternative involves constructing a combination sediment/detention basin at the base of Stream 4, downstream of SOC1_1. The basin embankment will be 30 feet high and will have a clay core, a polyurethane liner, a chimney drain, and will have 18-inch riprap on the interior face. Embankment height includes 5 feet of freeboard for PMP event. Approximately 51 acre-feet of excavation will be required for flood and sediment pool storage, of which a portion will be covered with a clay blanket. A box culvert principal outlet and an earthen auxiliary spillway will be included in the design.	Sediment/Detention Basin	\$1,705,654	\$2,302,633	\$2,404,541	\$2,400,000	\$1,950,000	\$1,320,000	\$1,080,000	X
			Property	\$101,908	\$101,908						
Stream 5											
SOC3_1	Downstream flooding and sediment load due to uncontrolled flows from Stream 5.	This alternative involves constructing a combination sediment/detention basin at the base of Stream 5. The basin embankment will be 26 feet high and will have a clay core, a polyurethane liner, a chimney drain, and will have 18-inch riprap on the interior face. Embankment height includes 5 feet of freeboard for PMP event. Approximately 8 acre-feet of excavation will be required for flood and sediment pool storage, of which a portion will be covered with a clay blanket. A box culvert principal outlet and an earthen auxiliary spillway will be included in the design.	Sediment/Detention Basin	\$622,448	\$840,305	\$866,842	\$870,000	\$700,000	\$480,000	\$390,000	X
			Property	\$26,537	\$26,537						
Stream 5.5											
SOC4_1	Downstream flooding and sediment load due to uncontrolled flows from Stream 5.5.	This alternative involves constructing a combination sediment/detention basin at the base of Stream 5.5. The basin embankment will be 29 feet high and will have a clay core, a polyurethane liner, a chimney drain, and will have 18-inch riprap on the interior face. Embankment height includes 5 feet of freeboard for PMP event. Approximately 10 acre-feet of excavation will be required for flood and sediment pool storage, of which a portion will be covered with a clay blanket. A box culvert principal outlet and an earthen auxiliary spillway will be included in the design.	Sediment/Detention Basin	\$739,907	\$998,874	\$1,177,501	\$1,180,000	\$950,000	\$650,000	\$530,000	X
			Property	\$178,626	\$178,626						
Mesa Spur Drain											
SOC5_1	Crossing capacity at Carr Road and Mesa Spur Drain is less than capacity of channel immediately upstream of crossing.	This alternative involves removing the existing 48-inch CMP culvert and replacing it with two 7-foot by 7-foot CBCs. This culvert size provides capacity equal to or greater than that of the upstream channel.	2 - 7' x 7' CBC	\$128,426	\$173,375	\$173,375	\$170,000	N/A	N/A	N/A	X
SOC6_1	Crossing capacity at Coker Road and Mesa Spur Drain is less than capacity of channel immediately upstream of crossing.	This alternative involves removing the existing 48-inch CMP culvert and replacing it with two 7-foot by 7-foot CBCs. This culvert size provides capacity equal to or greater than that of the upstream channel.	2 - 7' x 7' CBC	\$102,741	\$138,700	\$138,700	\$140,000	N/A	N/A	N/A	X
SOC7_1	Crossing capacity at Anderson Road and Mesa Spur Drain is less than capacity of channel immediately upstream of crossing.	This alternative involves removing the existing 48-inch CMP culvert and replacing it with two 7-foot by 7-foot CBCs. This culvert size provides capacity equal to or greater than that of the upstream channel.	2 - 7' x 7' CBC	\$116,926	\$157,850	\$157,850	\$160,000	N/A	N/A	N/A	X
SOC8_1	Crossing capacity at Carr Road and Mesa Spur Drain is less than capacity of channel immediately upstream of crossing.	This alternative involves removing the existing 60-inch CMP culvert and replacing it with two 7-foot by 7-foot CBCs. This culvert size provides capacity equal to or greater than that of the upstream channel.	2 - 7' x 7' CBC	\$166,569	\$224,868	\$224,868	\$220,000	N/A	N/A	N/A	X
HACIENDA REAL											
Stream 6											
HAC1_1	Downstream flooding and sediment load due to uncontrolled flows from Stream 6. No low-level outlet in existing flood retention pond.	This alternative involves installing a low flow principal spillway in the existing basin. Additionally, parcels that extend into the basin will need to be acquired.	Low-level/Principal Spillway Outlet	\$490,000	\$661,500	\$749,524	\$750,000	N/A	N/A	N/A	X
			Property	\$88,024	\$88,024						

Table C-6. Alternative Costing Table (Continued)

Project No & Alternative	Issue to be Addressed	Description of Alternative	Component			Total Cost	Total Cost (Rounded to \$10,000)				Preferred Alternatives
			Description	Cost (No Contingency)	Cost		100-Year Protection	50-Year Basin Protection (81%)	25-Year Basin Protection (55%)	10-Year Basin Protection (45%)	
HACIENDA REAL (Continued)											
Stream 7											
HAC2_1	Downstream flooding and sediment load due to uncontrolled flows from Stream 7.	This alternative involves constructing two combination sediment/detention basins on Stream 7, one in the upper watershed (Basin B), and one at the downstream end of Stream 7 (Basin A). Basin A will be 15 feet high and will have a clay core, a polyurethane liner, a chimney drain, and will have 18-inch riprap on the interior face. Embankment height includes 5 feet of freeboard for PMP event. Approximately 5 acre-feet of excavation will be required for flood and sediment pool storage, of which a portion will be covered with a clay blanket. A box culvert principal outlet and an earthen auxiliary spillway will be included in the design. Basin B will be 26 feet high and will have a clay core, a polyurethane liner, a chimney drain, and will have 18-inch riprap on the interior face. Embankment height includes 5 feet of freeboard for PMP event. Approximately 85 acre-feet of excavation will be required for flood and sediment pool storage, of which a portion will be covered with a clay blanket. A box culvert principal outlet and an earthen auxiliary spillway will be included in the design.	Sediment/Detention Basin at Location A	\$1,067,494	\$1,441,117	\$9,521,586	\$9,520,000	\$7,710,000	\$5,240,000	\$4,280,000	
			Property at Location A	\$69,170	\$69,170						
			Sediment/Detention Basin at Location B	\$5,902,700	\$7,968,645						
			Property at Location B	\$42,654	\$42,654						
HAC2_2	Crossing capacity at Bridgeway Drive and Stream 7 is less than 100-year flood and has a history of sediment and washout issues.	This alternative involves constructing two combination sediment/detention basins on Stream 7, one in the upper watershed (Basin B), and one at the downstream end of Stream 7 (Basin A). Basin A will be 16 feet high and will have a clay core, a polyurethane liner, a chimney drain, and will have 18-inch riprap on the interior face. Embankment height includes 5 feet of freeboard for PMP event. Approximately 6 acre-feet of excavation will be required for flood and sediment pool storage, of which a portion will be covered with a clay blanket. A box culvert principal outlet and an earthen auxiliary spillway will be included in the design. Basin B will be 28 feet high and will have a clay core, a polyurethane liner, a chimney drain, and will have 18-inch riprap on the interior face. Embankment height includes 5 feet of freeboard for PMP event. Approximately 101 acre-feet of excavation will be required for flood and sediment pool storage, of which a portion will be covered with a clay blanket. A box culvert principal outlet and an earthen auxiliary spillway will be included in the design.	Sediment/Detention Basin at Location A	\$961,717	\$1,298,318	\$10,568,301	\$10,570,000	\$8,560,000	\$5,810,000	\$4,760,000	X
			Property at Location A	\$69,170	\$69,170						
			Sediment/Detention Basin at Location B	\$6,783,821	\$9,158,159						
			Property at Location B	\$42,654	\$42,654						
HAC8_1	Crossing capacity at Bridgeway Drive and Stream 7 is less than 100-year flood and has a history of sediment and washout issues.	This alternative involves removing the existing five 48-inch CMP culverts and replacing it with five 4-foot by 4-foot CBCs. This culvert size provides sufficient capacity provided that additional storage is provided upstream per HAC2_1 or HAC2_2.	5 - 4' x 4' CBC	\$338,539	\$457,028	\$457,028	\$460,000	N/A	N/A	N/A	X
HAC8_2			6 - 6' x 6' CBC	\$831,307	\$1,122,264						
Stream 8											
HAC3_1	Downstream flooding and sediment load due to uncontrolled flows from Stream 8.	This alternative involves constructing a combination sediment/detention basin at the base of Stream 8. The basin embankment will be 13 feet high and will have a clay core, a polyurethane liner, a chimney drain, and will have 18-inch riprap on the interior face. Embankment height includes 5 feet of freeboard for PMP event. Approximately 15 acre-feet of excavation will be required for flood and sediment pool storage, of which a portion will be covered with a clay blanket. A box culvert principal outlet and an earthen auxiliary spillway will be included in the design.	Sediment/Detention Basin	\$1,367,321	\$1,845,883	\$1,873,717	\$1,870,000	\$1,520,000	\$1,030,000	\$840,000	
			Property	\$27,833	\$27,833						
HAC3_2	Downstream flooding and sediment load due to uncontrolled flows from Stream 8.	This alternative involves constructing a combination sediment/retention basin at the base of Stream 8. The basin embankment will be 6 feet high and will have a clay core, a polyurethane liner, a chimney drain, and will have 18-inch riprap on the interior face. Approximately 64 acre-feet of excavation will be required for flood and sediment pool storage.	Sediment/Retention Basin	\$1,582,638	\$2,136,561	\$2,164,394	\$2,160,000	\$1,750,000	\$1,190,000	\$970,000	X
			Property	\$27,833	\$27,833						

Table C-6. Alternative Costing Table (Continued)

Project No & Alternative	Issue to be Addressed	Description of Alternative	Component			Total Cost	Total Cost (Rounded to \$10,000)				Preferred Alternatives
			Description	Cost (No Contingency)	Cost		100-Year Protection	50-Year Basin Protection (81%)	25-Year Basin Protection (55%)	10-Year Basin Protection (45%)	
HACIENDA REAL (Continued)											
Streams 9 and 10											
HAC4_1	Downstream flooding and sediment load due to uncontrolled flows from Streams 9 and 10.	This alternative involves constructing a combination sediment/detention basin at the base of Streams 9 and 10. The basin embankment will be 11 feet high and will have a clay core, a polyurethane liner, a chimney drain, and will have 18-inch riprap on the interior face. Embankment height includes 5 feet of freeboard for PMP event. Approximately 9 acre-feet of excavation will be required for flood and sediment pool storage, of which a portion will be covered with a clay blanket. A box culvert principal outlet and an earthen auxiliary spillway will be included in the design.	Sediment/Detention Basin	\$996,646	\$1,345,473	\$1,386,152	\$1,390,000	\$1,120,000	\$760,000	\$620,000	
			Property	\$40,680	\$40,680						
HAC4_2		This alternative involves constructing a combination sediment/retention basin at the base of Streams 9 and 10. The basin embankment will be 6 feet high and will have a clay core, a polyurethane liner, a chimney drain, and will have 18-inch riprap on the interior face. Approximately 36 acre-feet of excavation will be required for flood and sediment pool storage.	Sediment/Retention Basin	\$1,090,802	\$1,472,582	\$1,513,262	\$1,510,000	\$1,230,000	\$830,000	\$680,000	X
			Property	\$40,680	\$40,680						
Stream 11											
HAC5_1	Downstream flooding and sediment load due to uncontrolled flows from Stream 11.	This alternative involves constructing a combination sediment/detention basin at the base of Stream 11. The basin embankment will be 13 feet high and will have a clay core, a polyurethane liner, a chimney drain, and will have 18-inch riprap on the interior face. Embankment height includes 5 feet of freeboard for PMP event. Approximately 20 acre-feet of excavation will be required for flood and sediment pool storage, of which a portion will be covered with a clay blanket. A box culvert principal outlet and an earthen auxiliary spillway will be included in the design.	Sediment/Detention Basin	\$1,709,719	\$2,308,121	\$2,322,034	\$2,320,000	\$1,880,000	\$1,280,000	\$1,040,000	
			Property	\$13,913	\$13,913						
HAC5_2		This alternative involves constructing a combination sediment/retention basin at the base of Stream 11. The basin embankment will be 6 feet high and will have a clay core, a polyurethane liner, a chimney drain, and will have 18-inch riprap on the interior face. Approximately 61 acre-feet of excavation will be required for flood and sediment pool storage.	Sediment/Retention Basin	\$1,720,462	\$2,322,624	\$2,336,537	\$2,340,000	\$1,890,000	\$1,290,000	\$1,050,000	X
			Property	\$13,913	\$13,913						
Streams 12 and 13											
HAC6_1	Downstream flooding and sediment load due to uncontrolled flows from Streams 12 and 13.	This alternative involves constructing a combination sediment/detention basin at the base of Streams 12 and 13. The basin embankment will be 18 feet high and will have a clay core, a polyurethane liner, a chimney drain, and will have 18-inch riprap on the interior face. Embankment height includes 5 feet of freeboard for PMP event. Approximately 31 acre-feet of excavation will be required for flood and sediment pool storage, of which a portion will be covered with a clay blanket. A box culvert principal outlet and an earthen auxiliary spillway will be included in the design.	Sediment/Detention Basin	\$2,374,038	\$3,204,952	\$3,209,093	\$3,210,000	\$2,600,000	\$1,770,000	\$1,440,000	
			Property	\$4,142	\$4,142						
HAC6_2		This alternative involves constructing a combination sediment/retention basin at the base of Streams 12 and 13. The basin embankment will be 6 feet high and will have a clay core, a polyurethane liner, a chimney drain, and will have 18-inch riprap on the interior face. Approximately 127 acre-feet of excavation will be required for flood and sediment pool storage.	Sediment/Retention Basin	\$2,623,414	\$3,541,609	\$3,545,751	\$3,550,000	\$2,870,000	\$1,950,000	\$1,600,000	X
			Property	\$4,142	\$4,142						

Table C-6. Alternative Costing Table (Continued)

Project No & Alternative	Issue to be Addressed	Description of Alternative	Component			Total Cost	Total Cost (Rounded to \$10,000)				Preferred Alternatives
			Description	Cost (No Contingency)	Cost		100-Year Protection	50-Year Basin Protection (81%)	25-Year Basin Protection (55%)	10-Year Basin Protection (45%)	
HACIENDA REAL (Continued)											
Stream 13.5											
HAC7_1	Downstream flooding and sediment load due to uncontrolled flows from Stream 13.5.	This alternative involves constructing two combination sediment/detention basins on Stream 13.5, one in the upper watershed (Basin B), and one at the downstream end of Stream 13.5 (Basin A). Basin A embankment will be 6 feet high and will have a clay core, a polyurethane liner, a chimney drain, and will have 18-inch riprap on the interior face. Embankment height includes 5 feet of freeboard for PMP event. Approximately 3 acre-feet of excavation will be required for flood and sediment pool storage, of which a portion will be covered with a clay blanket. A box culvert principal outlet and an earthen auxiliary spillway will be included in the design. Basin B embankment will be 6 feet high and will have a clay core, a polyurethane liner, a chimney drain, and will have 18-inch riprap on the interior face. Embankment height includes 5 feet of freeboard for PMP event. Approximately 13 acre-feet of excavation will be required for flood and sediment pool storage, of which a portion will be covered with a clay blanket. A box culvert principal outlet and an earthen auxiliary spillway will be included in the design.	Sediment/Detention Basin at Location A	\$673,657	\$909,438	\$2,706,851	\$2,710,000	\$2,190,000	\$1,490,000	\$1,220,000	X
			Property at Location A	\$4,428	\$4,428						
			Sediment/Detention Basin at Location B	\$1,307,223	\$1,764,752						
			Property at Location B	\$28,234	\$28,234						
HAC7_2		This alternative involves constructing a combination sediment/retention basin and a combination sediment/detention basin on Stream 13.5, one in the upper watershed (Basin B), and one at the downstream end of Stream 13.5 (Basin A). Basin A (retention) embankment will be 15 feet high and will have a clay core, a polyurethane liner, a chimney drain, and will have 18-inch riprap on the interior face. Embankment height includes 5 feet of freeboard for PMP event. Approximately 18 acre-feet of excavation will be required for flood and sediment pool storage, of which a portion will be covered with a clay blanket. A box culvert principal outlet and an earthen auxiliary spillway will be included in the design. Basin B embankment will be 6 feet high and will have a clay core, a polyurethane liner, a chimney drain, and will have 18-inch riprap on the interior face. Embankment height includes 5 feet of freeboard for PMP event. Approximately 13 acre-feet of excavation will be required for flood and sediment pool storage, of which a portion will be covered with a clay blanket. A box culvert principal outlet and an earthen auxiliary spillway will be included in the design.	Sediment/Retention Basin at Location A	\$1,447,397	\$1,953,986	\$3,751,400	\$3,750,000	\$3,040,000	\$2,060,000	\$1,690,000	
			Property at Location A	\$4,428	\$4,428						
			Sediment/Detention Basin at Location B	\$1,307,223	\$1,764,752						
			Property at Location B	\$28,234	\$28,234						
Mesa Drain											
HAC10_1	Crossing capacity at Northloop Drive and Mesa Drain is less than capacity of channel immediately upstream of crossing.	This alternative involves removing the existing 60-inch RCP culvert and replacing it with three 4-foot by 4-foot CBCs. This culvert size provides capacity equal to or greater than that of the upstream channel.	3 - 4' x 4' CBC	\$96,922	\$130,845	\$130,845	\$130,000	N/A	N/A	N/A	X
HAC11_1	Crossing capacity at FM 1110 and Mesa Drain is less than capacity of channel immediately upstream of crossing. Crossing is silted in and collapsed.	This alternative involves removing the existing 42-inch CMP culvert and replacing it with two 7-foot by 7-foot CBCs. This culvert size provides capacity slightly lower than that of channel immediately upstream, but provides maximum opening allowable for crossing and channel geometry.	2 - 7' x 7' CBC	\$382,091	\$515,823	\$515,823	\$520,000	N/A	N/A	N/A	X
HAC12_1	Crossing capacity at Salatral Lateral and Mesa Drain is less than capacity of channel immediately upstream of crossing.	This alternative involves removing the existing 36-inch RCP culvert and replacing it with two 7-foot by 7-foot CBCs. This culvert size provides capacity equal to or greater than that of the upstream channel.	2 - 7' x 7' CBC	\$368,322	\$497,235	\$497,235	\$500,000	N/A	N/A	N/A	X
HAC13_1	Crossing capacity at Fenter Road and Mesa Drain is less than capacity/crossing size of upstream improved crossings.	This alternative involves removing the existing 72-inch CMP culvert and replacing it with two 7-foot by 7-foot CBCs. This culvert size provides capacity equal to or greater than that of the upstream channel.	2 - 7' x 7' CBC	\$405,525	\$547,458	\$547,458	\$550,000	N/A	N/A	N/A	X
HAC14_1	Crossing capacity at dirt crossing upstream of Celum Road and Mesa Drain is less than capacity of channel immediately upstream of crossing.	This alternative involves removing the existing 54-inch CMP culvert and replacing it with two 7-foot by 7-foot CBCs. This culvert size provides capacity slightly lower than that of channel immediately upstream, but provides maximum opening allowable for crossing and channel geometry.	2 - 7' x 7' CBC	\$168,544	\$227,535	\$227,535	\$230,000	N/A	N/A	N/A	X

Table C-6. Alternative Costing Table (Continued)

Project No & Alternative	Issue to be Addressed	Description of Alternative	Component			Total Cost	Total Cost (Rounded to \$10,000)				Preferred Alternatives
			Description	Cost (No Contingency)	Cost		100-Year Protection	50-Year Basin Protection (81%)	25-Year Basin Protection (55%)	10-Year Basin Protection (45%)	
HACIENDA REAL (Continued)											
Mesa Drain (Continued)											
HAC15_1	Crossing capacity at Celum Road and Mesa Drain is less than capacity of channel immediately upstream of crossing.	This alternative involves removing the existing 36-inch CMP culvert and replacing it with two 7-foot by 7-foot CBCs. This culvert size provides capacity equal to or greater than that of the upstream channel.	2 - 7' x 7' CBC	\$182,362	\$246,188	\$246,188	\$250,000	N/A	N/A	N/A	X
FABENS											
Fabens North 1											
FAB1_1	Downstream flooding and sediment load due to uncontrolled flows from Fabens North 1.	This alternative involves constructing a combination sediment/retention basin at the base of Fabens North 1. The basin embankment will be 15 feet high and will have a clay core, a polyurethane liner, a chimney drain, and will have 18-inch riprap on the interior face. Embankment height includes 5 feet of freeboard for PMP event. Approximately 27 acre-feet of excavation will be required for flood and sediment pool storage, of which a portion will be covered with a clay blanket. A box culvert principal outlet and an earthen auxiliary spillway will be included in the design.	Sediment/Retention Basin	\$1,867,553	\$2,521,197	\$2,540,044	\$2,540,000	\$2,060,000	\$1,400,000	\$1,140,000	X
			Property	\$18,847	\$18,847						
San Felipe Arroyo											
FAB2_1	Lack of ROW acquisition along San Felipe Arroyo to maintain channel capacity.	This alternative involves obtaining property along San Felipe Arroyo to maintain channel capacity.	Property	\$500,643	\$500,643	\$500,643	\$500,000	N/A	N/A	N/A	X
FAB3_1	Dam will not pass 75% PMP.	This alternative involves constructing 1,165 feet of 4-foot-high concrete parapet wall along the crest of Fabens Dam. In addition, the east auxiliary spillway will be widened 100 feet to a total width of 150 feet.	Parapet Wall (4 feet high)	\$784,649	\$1,059,276	\$1,338,060	\$1,340,000	N/A	N/A	N/A	X
			Widen Auxiliary Spillway	\$206,507	\$278,784						
TORNILLO											
High School Channel and South High School Channel											
TOR1_1	Downstream flooding and sediment load due to uncontrolled flows from High School Channel and South High School Channel.	This alternative involves constructing a combination sediment/retention basin at the base of the confluence of High School Channel and South High School Channel (TOR1_1 & TOR3_1) and a sediment basin in the upper watershed (TOR1_1A). TOR1_1 & TOR3_1 will be 14 feet high and will have a clay core, a polyurethane liner, a chimney drain, and will have 18-inch riprap on the interior face. Embankment height includes 5 feet of freeboard for PMP event. Approximately 12 acre-feet of excavation will be required for flood and sediment pool storage, of which a portion will be covered with a clay blanket. A box culvert principal outlet and an earthen auxiliary spillway will be included in the design. The sediment basin TOR1_1A will be for sediment pool storage only, no embankment required. Approximately 4 acre-feet of excavation will be required for sediment pool storage.	Sediment/Retention Basin (TOR 1_1 & TOR3_1), Tall	\$2,577,226	\$3,479,255	\$3,578,023	\$3,580,000	\$2,900,000	\$1,970,000	\$1,610,000	
			Property	\$5,606	\$5,606						
			Sediment Basin (TOR1_1A)	\$68,728	\$92,783						
			Property	\$379	\$379						
TOR1_2		This alternative involves constructing a combination sediment/retention basin at the base of the confluence of High School Channel and South High School Channel (TOR1_2 & TOR3_1) and a sediment basin in the upper watershed (TOR1_1A). TOR1_2 & TOR3_1 will be 6 feet high and will have a clay core, a polyurethane liner, a chimney drain, and will have 18-inch riprap on the interior face. Approximately 49 acre-feet of excavation will be required for flood and sediment pool storage, of which a portion will be covered with a clay blanket. A box culvert principal outlet and an earthen auxiliary spillway will be included in the design. The sediment basin TOR1_1A will be for sediment pool storage only, no embankment required. Approximately 4 acre-feet of excavation will be required for sediment pool storage.	Sediment/Retention Basin (TOR 1_2 & TOR3_1), short	\$1,725,036	\$2,328,799	\$2,427,566	\$2,430,000	\$1,970,000	\$1,340,000	\$1,090,000	X
			Property	\$5,606	\$5,606						
			Sediment Basin (TOR1_1A)	\$68,728	\$92,783						
			Property	\$379	\$379						
TOR2_1	Erosion of West Bank along the redirected portion of High School Channel.	This alternative involves riprap reinforcement along the west bank of High School Channel.	2,030' of Channel Bank Improvements	\$595,342	\$803,712	\$806,048	\$810,000	N/A	N/A	N/A	X
			Property	\$2,336	\$2,336						

Table C-6. Alternative Costing Table (Continued)

Project No & Alternative	Issue to be Addressed	Description of Alternative	Component			Total Cost	Total Cost (Rounded to \$10,000)				Preferred Alternatives
			Description	Cost (No Contingency)	Cost		100-Year Protection	50-Year Basin Protection (81%)	25-Year Basin Protection (55%)	10-Year Basin Protection (45%)	
TORNILLO (Continued)											
Flow Path T											
TOR3_1	Downstream flooding and sediment load due to uncontrolled flows from Flow Path T.	This alternative involves the utilization of the construction of the combination sediment/retention basin (TOR1_1 & TOR3_1) addressing issues for TOR1_1 and the construction of a sediment basin in the upper watershed (TOR3_1A). The combination sediment/retention basin is described above with the flow and sediment from Flow Path T accounted for. TOR1/3 must be constructed in order for this alternative to address the flooding issue associated with Flow Path T. The sediment basin TOR3_1A will be for sediment pool storage only, no embankment required. Approximately 2 acre-feet of excavation will be required for sediment pool storage. (This cost does not include the cost of constructing TOR1/3.)	Sediment Basin (TOR3_1A)	\$32,589	\$43,995	\$51,549	\$50,000	\$40,000	\$30,000	\$20,000	X
			Property	\$7,554	\$7,554						
Tornillo Handle Channel 1 and Tornillo Handle Channel 2											
TOR4_1	Downstream flooding and sediment load due to uncontrolled flows from Tornillo Handle Channel 1 and Tornillo Handle Channel 2.	This alternative involves constructing a combination sediment/retention basin at the confluence of Tornillo Handle Channel 1 with Tornillo Handle Channel 2 (TOR4_1 & TOR5_1). The basin embankment will be 10 feet high and will have a clay core, a polyurethane liner, a chimney drain, and will have 18-inch riprap on the interior face. Embankment height includes 5 feet of freeboard for PMP event. Approximately 7 acre-feet of excavation will be required for flood and sediment pool storage, of which a portion will be covered with a clay blanket. A box culvert principal outlet and an earthen auxiliary spillway will be included in the design.	Sediment/Retention Basin (TOR4_1 & TOR5_1)	\$992,339	\$1,339,658	\$1,340,876	\$1,340,000	\$1,090,000	\$740,000	\$600,000	X
			Property	\$1,218	\$1,218						
TOR5_1	Downstream flooding due to uncontrolled flows from Tornillo Handle Channel 1.	This alternative involves riprap reinforcement along the south bank of Tornillo Handle Channel 1.	165' of Channel Bank Improvements	\$154,245	\$208,231	\$209,234	\$210,000	N/A	N/A	N/A	X
			Property	\$1,003	\$1,003						
TOR6_1	Crossing capacity at OT Smith Road and Tornillo Handle Channel 2 is less than the necessary capacity.	This alternative involves removing the existing two 36-inch by 19-inch arch culvert and replacing it with two 4-foot by 2-foot CBCs. This culvert size provides sufficient capacity equal to that of the upstream channel.	2 - 4' x 2' CBC	\$36,447	\$49,203	\$49,203	\$50,000	N/A	N/A	N/A	X

* Issues, alternatives and cost identified in the City of EL Paso Stormwater Master Plan (SMP).

Table C-7. Evaluation of Detention Vs. Retention Alternatives

Project	Description	Cost (No Contingency)	Retention	Detention	Construction Cost	Property Cost	Construction Plus Property Cost	Total Property Cost (Rounded)	Total Cost (Rounded)	Retention/ Detention Increase	Flood Risk For Real Property			Arterial Flooding Risk		
											# Residences	Acres of Ag Land	Current Protection (Return Period in years)	Artery Name	Divided Hwy?	Critical Route?
CAN3_1	Retention Basin (CAN3_1B)	\$373,771			\$170,320	\$0	\$170,320	\$398,000	\$2,406,000	-29%	52	0	0	Doniphan Drive	No	Yes
	Retention Basin (CAN3_1A) - 20-foot height	\$1,361,052			\$1,837,420	\$397,973	\$2,235,393									
CAN3_2	Retention Basin (CAN3_1B)	\$373,771			\$170,320	\$0	\$170,320	\$398,000	\$1,711,000							
	Retention Basin (CAN3_1A) - 6-foot height	\$846,783			\$1,143,158	\$397,973	\$1,541,131									
HAC2_1	Sediment/Detention Basin at Location A	\$1,067,494		X	\$1,441,117	\$69,170	\$1,510,287	\$112,000	\$9,522,000	11%	53	214	0	IH-10; Bridgeway Drive; Northloop Drive	Yes; No; No	Yes; Yes; Yes
	Sediment/Detention Basin at Location B	\$5,902,700		X	\$7,968,645	\$42,654	\$8,011,299									
HAC2_2	Sediment/Retention Basin at Location A	\$961,717	X		\$1,298,318	\$69,170	\$1,367,488	\$112,000	\$10,568,000							
	Sediment/Retention Basin at Location B	\$6,783,821	X		\$9,158,159	\$42,654	\$9,200,813									
HAC3_1	Sediment/Detention Basin	\$1,367,321		X	\$1,845,883	\$27,833	\$1,873,716	\$27,833	\$1,874,000	15%	7	47	0	None	N/A	N/A
HAC3_2	Sediment/Retention Basin	\$1,105,779	X		\$2,136,561	\$27,833	\$2,164,394	\$27,833	\$2,164,000							
HAC4_1	Sediment/Detention Basin	\$996,646		X	\$1,345,473	\$40,680	\$1,386,153	\$40,680	\$1,386,000	9%	15	18	0	None	N/A	N/A
HAC4_2	Sediment/Retention Basin	\$469,319	X		\$1,472,582	\$40,680	\$1,513,262	\$40,680	\$1,513,000							
HAC5_1	Sediment/Detention Basin	\$1,709,719		X	\$2,308,121	\$13,913	\$2,322,034	\$13,913	\$2,322,000	1%	4	52	0	None	N/A	N/A
HAC5_2	Sediment/Retention Basin	\$819,896	X		\$2,322,624	\$13,913	\$2,336,537	\$13,913	\$2,337,000							
HAC6_1	Sediment/Detention Basin	\$2,374,038		X	\$3,204,952	\$4,142	\$3,209,094	\$4,142	\$3,209,000	11%	11	15	0	None	N/A	N/A
	Sediment/Retention Basin	\$1,682,061	X		\$3,541,609	\$4,142	\$3,545,751	\$4,142	\$3,546,000							
HAC7_1	Sediment/Detention Basin at Location A	\$673,657		X	\$909,438	\$4,428	\$913,866	\$33,000	\$2,707,000	39%	3	415	0	Northloop Drive	No	Yes
	Sediment/Detention Basin at Location B	\$1,307,223		X	\$1,764,752	\$28,234	\$1,792,986									
HAC7_2	Sediment/Retention Basin at Location A	\$1,447,397	X		\$1,953,986	\$4,428	\$1,958,414	\$33,000	\$3,751,000							
	Sediment/Detention Basin at Location B	\$1,307,223	X		\$1,764,752	\$28,234	\$1,792,986									
TOR1_1	Sediment/Retention Basin (TOR 1_1 & TOR3_1) - 14-foot height	\$2,577,226			\$3,479,255	\$379	\$3,479,634	\$6,000	\$3,578,000	-32%	81	0	0	None	N/A	N/A
	Sediment Basin (TOR1_1B)	\$68,728			\$92,783	\$5,606	\$98,389									
TOR1_2	Sediment/Retention Basin (TOR 1_1 & TOR3_1) - 6-foot height	\$1,725,036	X		\$2,328,799	\$379	\$2,329,178	\$6,000	\$2,428,000							
	Sediment Basin (TOR1_1B)	\$68,728	X		\$92,783	\$5,606	\$98,389									

Table C-8. Stormwater Projects

Study Area	Alternative No.	Project No.	Issue to be addressed	Description of Improvements	Total Cost
Vinton	VIN1_1*	VIN1*	Flooding along channel due to uncontrolled flows from Flow Path Number 45A and Flow Path Number 45.	This project involves constructing a diversion channel upstream of Remington Drive directing the flow to Flow Path Number 45, and two combination sediment/detention basins. One basin on the north portion of the upper watershed (Basin A) and the other on the south portion of the upper watershed (Basin B). Basin A will be 24 feet high. Approximately 380 acre-feet of excavation will be required for flood and sediment pool storage. A principal outlet and an earthen auxiliary spillway will be included in the design. Basin B will be 23 feet high. Approximately 200 acre-feet of excavation will be required for flood and sediment pool storage. A principal outlet and an earthen auxiliary spillway will be included in the design.	\$21,810,000
Vinton	VIN2_1*	VIN2*	Area flooding due to uncontrolled flows from Flow Path Number 45A.	This project involves increasing 950 feet of the lower portion of Flow Path Number 45A channel capacity from 240 feet upstream of Iron Drive to 260 feet downstream of Kiely Road.	\$240,000
Vinton	VIN3_1*	VIN3*	Area flooding due to uncontrolled flows from Flow Path Number 45.	This project involves increasing 1,600 feet of the upper portion of Flow Path Number 45 channel capacity to convey the outflow of the basins associated with VIN1*. The effectiveness of VIN3* is dependent on VIN1* being constructed.	\$120,000
Vinton	VIN4_1*	VIN4*	Area flooding due to uncontrolled flows from Flow Path Number 45.	This project involves increasing 4,500 feet of the middle portion of Flow Path Number 45 channel capacity to convey the outflow of the basins associated with VIN1*.	\$860,000
Vinton	VIN7_1*	VIN7*	Crossing capacity at Railroad and Flow Path Number 45 is less than the necessary capacity.	This project involves expanding the existing bridge to cross the improved channel. This will provide sufficient capacity equal to the channel improvements.	\$620,000
Vinton	VIN8_1*	VIN8*	Crossing capacity at Doniphan Drive and Flow Path Number 45 is less than the necessary capacity.	This project involves removing the existing two 6-foot by 6-foot culverts and replacing it with a bridge. This will provide sufficient capacity equal to the upstream channel.	\$1,260,000
Vinton	VIN9_1*	VIN9*	Crossing capacity at AP Ramirez and Flow Path Number 45 is less than the necessary capacity.	This project involves removing the existing four 36-inch culverts and replacing it with a bridge. This will provide sufficient capacity equal to the upstream channel.	\$1,410,000
Vinton	VIN11_1*	VIN10*	Crossing capacity at Kiely Road and Flow Path Number 45 is less than the necessary capacity.	This project involves removing the existing two 8-foot by 3-foot culverts and replacing it with a bridge. This will provide sufficient capacity equal to the upstream channel.	\$730,000
Vinton	VIN12_1*	VIN11*	Crossing capacity at Quejette Drive and Flow Path Number 45 is less than the necessary capacity.	This project involves removing the at grade crossing and replacing it with a bridge. This will provide sufficient capacity equal to the upstream channel.	\$700,000
Vinton	VIN13_1*	VIN12*	Crossing capacity at IH-10 Northbound off-ramp and Flow Path Number 45 is less than the necessary capacity.	This project involves adding three more 9-foot by 5-foot culverts to the existing battery of culverts. This addition of culverts provides sufficient capacity equal to the upstream channel.	\$200,000

Table C-8. Stormwater Projects (Continued)

Study Area	Alternative No.	Project No.	Issue to be addressed	Description of Improvements	Total Cost
Vinton	VIN14_1*	VIN13*	Crossing capacity at Kiely Road and Flow Path Number 45A is less than the necessary capacity.	This project involves removing the existing two 30-inch round concrete pipes and replacing it with five 7-foot by 4-foot culverts. This culvert size provides sufficient capacity equal to the upstream channel.	\$260,000
Vinton	VIN15_1*	VIN14*	Crossing capacity at Iron Drive and Flow Path Number 45A is less than the necessary capacity.	This project involves removing the existing three 30-inch round concrete pipes and replacing them with six 6-foot by 6-foot culverts. This culvert size provides sufficient capacity equal to the upstream channel.	\$310,000
Vinton	VIN5_1	VIN5	Downstream flooding due to uncontrolled flows from Flow Path Number 44.	This project involves increasing 2,054 feet of Flow Path Number 44 channel capacity to convey the 100-year flood.	\$860,000
Vinton	VIN6_1	VIN6	Crossing capacity at Doniphan Drive and Flow Path Number 44 is less than the necessary capacity.	This project involves removing the existing 16-foot by 5-foot culvert and replacing it with three 9-foot by 8-foot culverts. This culvert size provides sufficient capacity equal to the upstream channel.	\$600,000
Canutillo	CAN1_1	CAN1	Downstream flooding and sediment load due to uncontrolled flows from Flow Path Number 42 and lack of maintenance of channel due to ROW issues.	This project involves reconstructing the channel to convey the 100-year flood, with a concrete lining. Additionally, properties that extend into the channel will need to be acquired.	\$1,440,000
Canutillo	CAN3_2	CAN2	Localized flooding due to lack of flood control structures.	This project involves constructing two retention basins and utilizing an existing basin. One of the constructed basins (Basin B) will be located at the downstream end of First Avenue Channel and the second (Basin A) in a vacant area east of the intersection of West Avenue and Third Avenue. Basin B will not require an embankment. Approximately 11 acre-feet of excavation will be required for flood pool storage. Basin A will be 6 feet high and will have a clay core, a polyurethane liner, a chimney drain, and will have 18-inch riprap on the interior face. Approximately 21 acre-feet of excavation will be required for flood pool storage, of which a portion will be covered with a clay blanket. A low flow principal spillway will be included to convey flow as Basin A reaches capacity. Additionally, improvements will be made to First Avenue Channel.	\$4,360,000
Canutillo	CAN4_1	CAN3	Crossing capacity at Doniphan Drive and First Avenue Channel is less than the necessary capacity.	This project involves removing the existing two 6-foot by 3-foot culvert and replacing it with the same size culvert, ensuring the culvert in sloping in the correct direction to drain. This culvert size provides sufficient capacity provided that additional storage is provided upstream per CAN2.	\$140,000
Sparks Arroyo and Sub Basin A	SSA1_1	SSA1	Uncontrolled flows from Arroyos A1, A2, and A3 are causing flooding problems in downstream communities.	This project involves constructing a detention basin that will capture flow from Arroyos A1, A2, and A3. The basin will be 41 feet high and will have a clay core, a polyurethane liner, a chimney drain, and will have 18-inch riprap on the interior face. Embankment height includes 10 feet of freeboard for PMP event. Approximately 306 acre-feet of excavation will be required for flood pool storage, of which a portion will be covered with a clay blanket. Approximately 1,041 acre-feet of flood and sediment pool storage will be provided by this basin.	\$22,630,000

Table C-8. Stormwater Projects (Continued)

Study Area	Alternative No.	Project No.	Issue to be addressed	Description of Improvements	Total Cost
Sparks Arroyo and Sub Basin A	SSA2_1	SSA2	Uncontrolled flows from Arroyo A4 are causing flooding problems in downstream communities.	This project involves constructing a detention basin that will capture flow from Arroyo A4. The basin will be 22 feet high and will have a clay core, a polyurethane liner, a chimney drain, and will have 18-inch riprap on the interior face. Embankment height includes 6 feet of freeboard for PMP event. Approximately 46 acre-feet of excavation will be required for flood pool storage, of which a portion will be covered with a clay blanket. Approximately 121 acre-feet of flood and sediment pool storage will be provided by this basin.	\$4,360,000
Sparks Arroyo and Sub Basin A	SSA3_1	SSA3	Uncontrolled flows from Arroyos A5 and A6 are causing flooding problems in downstream communities.	This project involves constructing a detention basin that will capture flow from Arroyos A5 and A6. The basin will be 36 feet high and will have a clay core, a polyurethane liner, a chimney drain, and will have 18-inch riprap on the interior face. Embankment height includes 7 feet of freeboard for PMP event. Approximately 67 acre-feet of excavation will be required for flood pool storage, of which a portion will be covered with a clay blanket. Approximately 171 acre-feet of flood and sediment pool storage will be provided by this basin. 1,100 feet of Arroyo A5 will be reshaped and lined to divert flow to the basin as part of this improvement.	\$6,170,000
Sparks Arroyo and Sub Basin A	SSA4_1	SSA4	Flows entering the Sparks Arroyo from the upstream mesa are creating capacity issues for the arroyo and flooding problems downstream.	This project involves constructing a detention basin that will capture flow from the mesa above Sparks Arroyo. The basin will be 37 feet high and will have a clay core, a polyurethane liner, a chimney drain, and will have 18-inch riprap on the interior face. Embankment height includes 10 feet of freeboard for PMP event. Approximately 139 acre-feet of excavation will be required for flood pool storage, of which a portion will be covered with a clay blanket. Approximately 639 acre-feet of flood and sediment pool storage will be provided by this basin.	\$11,600,000
Sparks Arroyo and Sub Basin A	SSA5_1	SSA5	The Sparks Arroyo is currently experiencing erosion along its banks.	This project involves defining the Sparks Arroyo and lining it with concrete to prevent further erosion and add capacity. Approximately 10,300 feet of channel improvements. In addition, a crossing will need to be constructed under Stockyard Drive.	\$8,690,000
Sparks Arroyo and Sub Basin A	SSA6_1	SSA6	Runoff from the Sparks Community is contributing to flooding problems downstream of the Sparks Arroyo.	This project involves constructing two retention basins within the Sparks Community west of the Sparks Arroyo. The north basin will need to be excavated to a volume of approximately 8 acre-feet and will have a 940-foot long concrete lined channel diverting water to it from the north and a 390-foot concrete lined channel from the south. The south basin will need to be excavated to a volume of approximately 13 acre-feet and will have a 980-foot long concrete lined channel diverting water to it from the north and a 250-foot concrete lined channel from the south.	\$1,910,000
Sparks Arroyo and Sub Basin A	SSA7_1	SSA7	Uncontrolled flows from the Sparks Arroyo are causing flooding problems in downstream communities.	This project involves constructing a 684 acre-foot retention basin south of Stockyard Drive, at the mouth of the Sparks Arroyo. The basin will be approximately 54 feet deep and will have a 6-foot embankment that will have a clay core, a polyurethane liner, a chimney drain, and will have 18-inch riprap on the interior face. In addition, the existing channel along Stockyard Drive will be expanded, lined with concrete, and redirected to the proposed Valley Ridge Basin. The entire length of the channel improvements is 3,500 feet. The three existing crossings along this channel will need to be installed and one new crossing will need to be constructed.	\$20,300,000

Table C-8. Stormwater Projects (Continued)

Study Area	Alternative No.	Project No.	Issue to be addressed	Description of Improvements	Total Cost
Socorro	SOC1_1	SOC1	Downstream flooding and sediment load due to uncontrolled flows from Stream 4 passing through the breached El Paso Hills Dam.	This project involves repairing the existing 15-foot-high embankment, adding 18-inch riprap to the interior embankment, adding principal and auxiliary spillways, and excavating approximately 33 acre-feet from the basin to provide flood and sediment pool storage.	\$1,240,000
Socorro	SOC2_1	SOC2	Downstream flooding and sediment load due to uncontrolled flows from Stream 4.	This project involves constructing a combination sediment/detention basin at the base of Stream 4, downstream of SOC1. The basin embankment will be 30 feet high and will have a clay core, a polyurethane liner, a chimney drain, and will have 18-inch riprap on the interior face. Embankment height includes 5 feet of freeboard for PMP event. Approximately 51 acre-feet of excavation will be required for flood and sediment pool storage, of which a portion will be covered with a clay blanket. A box culvert principal outlet and an earthen auxiliary spillway will be included in the design.	\$2,400,000
Socorro	SOC3_1	SOC3	Downstream flooding and sediment load due to uncontrolled flows from Stream 5.	This project involves constructing a combination sediment/detention basin at the base of Stream 5. The basin embankment will be 26 feet high and will have a clay core, a polyurethane liner, a chimney drain, and will have 18-inch riprap on the interior face. Embankment height includes 5 feet of freeboard for PMP event. Approximately 8 acre-feet of excavation will be required for flood and sediment pool storage, of which a portion will be covered with a clay blanket. A box culvert principal outlet and an earthen auxiliary spillway will be included in the design.	\$870,000
Socorro	SOC4_1	SOC4	Downstream flooding and sediment load due to uncontrolled flows from Stream 5.5.	This project involves constructing a combination sediment/detention basin at the base of Stream 5.5. The basin embankment will be 29 feet high and will have a clay core, a polyurethane liner, a chimney drain, and will have 18-inch riprap on the interior face. Embankment height includes 5 feet of freeboard for PMP event. Approximately 10 acre-feet of excavation will be required for flood and sediment pool storage, of which a portion will be covered with a clay blanket. A box culvert principal outlet and an earthen auxiliary spillway will be included in the design.	\$1,180,000
Socorro	SOC5_1	SOC5	Crossing capacity at Carr Road and Mesa Spur Drain is less than capacity of channel immediately upstream of crossing.	This project involves removing the existing 48-inch CMP culvert and replacing it with two 7-foot by 7-foot CBCs. This culvert size provides capacity equal to or greater than that of the upstream channel.	\$170,000
Socorro	SOC6_1	SOC6	Crossing capacity at Coker Road and Mesa Spur Drain is less than capacity of channel immediately upstream of crossing.	This project involves removing the existing 48-inch CMP culvert and replacing it with two 7-foot by 7-foot CBCs. This culvert size provides capacity equal to or greater than that of the upstream channel.	\$140,000
Socorro	SOC7_1	SOC7	Crossing capacity at Anderson Road and Mesa Spur Drain is less than capacity of channel immediately upstream of crossing.	This project involves removing the existing 48-inch CMP culvert and replacing it with two 7-foot by 7-foot CBCs. This culvert size provides capacity equal to or greater than that of the upstream channel.	\$160,000

Table C-8. Stormwater Projects (Continued)

Study Area	Alternative No.	Project No.	Issue to be addressed	Description of Improvements	Total Cost
Socorro	SOC8_1	SOC8	Crossing capacity at Carr Road and Mesa Spur Drain is less than capacity of channel immediately upstream of crossing.	This project involves removing the existing 60-inch CMP culvert and replacing it with two 7-foot by 7-foot CBCs. This culvert size provides capacity equal to or greater than that of the upstream channel.	\$220,000
Hacienda Real	HAC1_1	HAC1	Downstream flooding and sediment load due to uncontrolled flows from Stream 6. No low-level outlet in existing flood retention pond.	This project involves installing a low flow principal spillway in the existing basin. Additionally, parcels that extend into the basin will need to be acquired.	\$750,000
Hacienda Real	HAC2_2	HAC2	Downstream flooding and sediment load due to uncontrolled flows from Stream 7.	This project involves constructing two combination sediment/detention basins on Stream 7, one in the upper watershed (Basin B), and one at the downstream end of Stream 7 (Basin A). Basin A will be 16 feet high and will have a clay core, a polyurethane liner, a chimney drain, and will have 18-inch riprap on the interior face. Embankment height includes 5 feet of freeboard for PMP event. Approximately 6 acre-feet of excavation will be required for flood and sediment pool storage, of which a portion will be covered with a clay blanket. A box culvert principal outlet and an earthen auxiliary spillway will be included in the design. Basin B will be 28 feet high and will have a clay core, a polyurethane liner, a chimney drain, and will have 18-inch riprap on the interior face. Embankment height includes 5 feet of freeboard for PMP event. Approximately 101 acre-feet of excavation will be required for flood and sediment pool storage, of which a portion will be covered with a clay blanket. A box culvert principal outlet and an earthen auxiliary spillway will be included in the design.	\$10,570,000
Hacienda Real	HAC8_1	HAC8	Crossing capacity at Bridgeway Drive and Stream 7 is less than 100-year flood and has a history of sediment and washout issues.	This project involves removing the existing five 48-inch CMP culverts and replacing it with five 4-foot by 4-foot CBCs. This culvert size provides sufficient capacity provided that additional storage is provided upstream per HAC2.	\$460,000
Hacienda Real	HAC3_2	HAC3	Downstream flooding and sediment load due to uncontrolled flows from Stream 8.	This project involves constructing a combination sediment/retention basin at the base of Stream 8. The basin embankment will be 6 feet high and will have a clay core, a polyurethane liner, a chimney drain, and will have 18-inch riprap on the interior face. Approximately 64 acre-feet of excavation will be required for flood and sediment pool storage.	\$2,160,000
Hacienda Real	HAC4_2	HAC4	Downstream flooding and sediment load due to uncontrolled flows from Streams 9 and 10.	This project involves constructing a combination sediment/retention basin at the base of Streams 9 and 10. The basin embankment will be 6 feet high and will have a clay core, a polyurethane liner, a chimney drain, and will have 18-inch riprap on the interior face. Approximately 36 acre-feet of excavation will be required for flood and sediment pool storage.	\$1,510,000
Hacienda Real	HAC5_2	HAC5	Downstream flooding and sediment load due to uncontrolled flows from Stream 11.	This project involves constructing a combination sediment/retention basin at the base of Stream 11. The basin embankment will be 6 feet high and will have a clay core, a polyurethane liner, a chimney drain, and will have 18-inch riprap on the interior face. Approximately 61 acre-feet of excavation will be required for flood and sediment pool storage.	\$2,340,000

Table C-8. Stormwater Projects (Continued)

Study Area	Alternative No.	Project No.	Issue to be addressed	Description of Improvements	Total Cost
Hacienda Real	HAC6_2	HAC6	Downstream flooding and sediment load due to uncontrolled flows from Streams 12 and 13.	This project involves constructing a combination sediment/retention basin at the base of Streams 12 and 13. The basin embankment will be 6 feet high and will have a clay core, a polyurethane liner, a chimney drain, and will have 18-inch riprap on the interior face. Approximately 127 acre-feet of excavation will be required for flood and sediment pool storage.	\$3,550,000
Hacienda Real	HAC7_1	HAC7	Downstream flooding and sediment load due to uncontrolled flows from Stream 13.5.	This project involves constructing two combination sediment/detention basins on Stream 13.5, one in the upper watershed (Basin B), and one at the downstream end of Stream 13.5 (Basin A). Basin A embankment will be 6 feet high and will have a clay core, a polyurethane liner, a chimney drain, and will have 18-inch riprap on the interior face. Embankment height includes 5 feet of freeboard for PMP event. Approximately 3 acre-feet of excavation will be required for flood and sediment pool storage, of which a portion will be covered with a clay blanket. A box culvert principal outlet and an earthen auxiliary spillway will be included in the design. Basin B embankment will be 6 feet high and will have a clay core, a polyurethane liner, a chimney drain, and will have 18-inch riprap on the interior face. Embankment height includes 5 feet of freeboard for PMP event. Approximately 13 acre-feet of excavation will be required for flood and sediment pool storage, of which a portion will be covered with a clay blanket. A box culvert principal outlet and an earthen auxiliary spillway will be included in the design.	\$2,710,000
Hacienda Real	HAC10_1	HAC9	Crossing capacity at Northloop Drive and Mesa Drain is less than capacity of channel immediately upstream of crossing.	This project involves removing the existing 60-inch RCP culvert and replacing it with three 4-foot by 4-foot CBCs. This culvert size provides capacity equal to or greater than that of the upstream channel.	\$130,000
Hacienda Real	HAC11_1	HAC10	Crossing capacity at FM 1110 and Mesa Drain is less than capacity of channel immediately upstream of crossing. Crossing is silted in and collapsed.	This project involves removing the existing 42-inch CMP culvert and replacing it with two 7-foot by 7-foot CBCs. This culvert size provides capacity slightly lower than that of channel immediately upstream, but provides maximum opening allowable for crossing and channel geometry.	\$520,000
Hacienda Real	HAC12_1	HAC11	Crossing capacity at Salatral Lateral and Mesa Drain is less than capacity of channel immediately upstream of crossing.	This project involves removing the existing 36-inch RCP culvert and replacing it with two 7-foot by 7-foot CBCs. This culvert size provides capacity equal to or greater than that of the upstream channel.	\$500,000
Hacienda Real	HAC13_1	HAC12	Crossing capacity at Fenter Road and Mesa Drain is less than capacity/crossing size of upstream improved crossings.	This project involves removing the existing 72-inch CMP culvert and replacing it with two 7-foot by 7-foot CBCs. This culvert size provides capacity equal to or greater than that of the upstream channel.	\$550,000
Hacienda Real	HAC14_1	HAC13	Crossing capacity at dirt crossing upstream of Celum Road and Mesa Drain is less than capacity of channel immediately upstream of crossing.	This project involves removing the existing 54-inch CMP culvert and replacing it with two 7-foot by 7-foot CBCs. This culvert size provides capacity slightly lower than that of channel immediately upstream, but provides maximum opening allowable for crossing and channel geometry.	\$230,000

Table C-8. Stormwater Projects (Continued)

Study Area	Alternative No.	Project No.	Issue to be addressed	Description of Improvements	Total Cost
Hacienda Real	HAC15_1	HAC14	Crossing capacity at Celum Road and Mesa Drain is less than capacity of channel immediately upstream of crossing.	This project involves removing the existing 36-inch CMP culvert and replacing it with two 7-foot by 7-foot CBCs. This culvert size provides capacity equal to or greater than that of the upstream channel.	\$250,000
Fabens	FAB1_1	FAB1	Downstream flooding and sediment load due to uncontrolled flows from Fabens North 1.	This project involves constructing a combination sediment/retention basin at the base of Fabens North 1. The basin embankment will be 15 feet high and will have a clay core, a polyurethane liner, a chimney drain, and will have 18-inch riprap on the interior face. Embankment height includes 5 feet of freeboard for PMP event. Approximately 27 acre-feet of excavation will be required for flood and sediment pool storage, of which a portion will be covered with a clay blanket. A box culvert principal outlet and an earthen auxiliary spillway will be included in the design.	\$2,540,000
Fabens	FAB2_1	FAB2	Lack of ROW acquisition along San Felipe Arroyo to maintain channel capacity.	This project involves obtaining property along San Felipe Arroyo to maintain channel capacity.	\$500,000
Fabens	FAB3_1	FAB3	Dam will not pass 75% PMP.	This project involves constructing 1,165 feet of 4-foot-high parapet wall along the crest of Fabens Dam. In addition, the east auxiliary spillway will be widened 100 feet to a total width of 150 feet.	\$1,340,000
Tornillo	TOR1_2	TOR1	Downstream flooding and sediment load due to uncontrolled flows from High School Channel and South High School Channel.	This project involves constructing a combination sediment/retention basin at the base of the confluence of High School Channel and South High School Channel (Basin B) and a sediment basin in the upper watershed (Basin A). Basin B will be 6 feet high and will have a clay core, a polyurethane liner, a chimney drain, and will have 18-inch riprap on the interior face. Approximately 49 acre-feet of excavation will be required for flood and sediment pool storage, of which a portion will be covered with a clay blanket. A box culvert principal outlet and an earthen auxiliary spillway will be included in the design. Basin A will be for sediment pool storage only, no embankment required. Approximately 4 acre-feet of excavation will be required for sediment pool storage.	\$2,430,000
Tornillo	TOR2_1	TOR2	Erosion of West Bank along the redirected portion of High School Channel.	This project involves riprap reinforcement along the west bank of High School Channel.	\$810,000
Tornillo	TOR3_1	TOR3	Downstream flooding and sediment load due to uncontrolled flows from Flow Path T.	This project involves the utilization of the construction of the combination sediment/retention basin (TOR1, Basin B) addressing issues for TOR1 and the construction of a sediment basin in the upper watershed (TOR3). TOR1, Basin B must be constructed in order for this project to address the flooding issue associated with Flow Path T. The sediment basin TOR3 will be for sediment pool storage only, no embankment required. Approximately 2 acre-feet of excavation will be required for sediment pool storage.	\$50,000

Table C-8. Stormwater Projects (Continued)

Study Area	Alternative No.	Project No.	Issue to be addressed	Description of Improvements	Total Cost
Tornillo	TOR4_1	TOR4	Downstream flooding and sediment load due to uncontrolled flows from Tornillo Handle Channel 1 and Tornillo Handle Channel 2.	This project involves constructing a combination sediment/retention basin at the confluence of Tornillo Handle Channel 1 with Tornillo Handle Channel 2. The basin embankment will be 10 feet high and will have a clay core, a polyurethane liner, a chimney drain, and will have 18-inch riprap on the interior face. Embankment height includes 5 feet of freeboard for PMP event. Approximately 7 acre-feet of excavation will be required for flood and sediment pool storage, of which a portion will be covered with a clay blanket. A box culvert principal outlet and an earthen auxiliary spillway will be included in the design.	\$1,340,000
Tornillo	TOR5_1	TOR5	Downstream flooding due to uncontrolled flows from Tornillo Handle Channel 1.	This project involves riprap reinforcement along the south bank of Tornillo Handle Channel 1.	\$210,000
Tornillo	TOR6_1	TOR6	Crossing capacity at OT Smith Road and Tornillo Handle Channel 2 is less than the necessary capacity.	This project involves removing the existing two 36-inch by 19-inch arch culvert and replacing it with two 4-foot by 2-foot CBCs. This culvert size provides sufficient capacity equal to that of the upstream channel.	\$50,000

* Issues, alternatives and cost identified in the City of El Paso Stormwater Master Plan (SMP).

Table C-9 Return Interval Analysis for Proposed Basins

Project	Return Interval	Estimated Construction Cost	Percentage of 100-Year Return Interval Cost	Average
HAC4_1	10	\$472,334	47%	45%
HAC5_1	10	\$840,776	48%	
SOC3_1	10	\$276,676	44%	
SOC4_1	10	\$286,844	39%	
HAC4_1	25	\$572,478	57%	55%
HAC5_1	25	\$1,116,881	64%	
SOC3_1	25	\$317,449	51%	
SOC4_1	25	\$342,149	46%	
HAC4_1	50	\$745,180	74%	81%
HAC5_1	50	\$1,500,529	86%	
SOC3_1	50	\$520,275	84%	
SOC4_1	50	\$605,209	82%	
HAC4_1	100	\$1,001,095	100%	100%
HAC5_1	100	\$1,743,153	100%	
SOC3_1	100	\$622,269	100%	
SOC4_1	100	\$739,782	100%	

This page was intentionally left blank.

Table C-10. Risk Reduction Benefit

Project Number	Description	Estimated Total Cost (Rounded to \$10,000)	Estimated Cost for 25-Year Return Interval Basin Design (Rounded to \$10,000)	Type of Improvement			Flood Risk for Real Property					Arterial Flooding Risk			Maintenance		Total Risk Reduction Benefit				
				Basin	Crossing	Channel	Number of Residences	Acres of Ag Land	Current Protection (Return Period in years)	Are Routine Floods Controlled?	Is Sediment Yield Reduced?	Risk Reduction Benefit	Artery Name	Divided Hwy?	Critical Route?	Risk Reduction Benefit		Current Maintenance Issue (1-5)	Risk Reduction Benefit		
VIN3*	1,600' of Channel Improvements	\$120,000	N/A			X	38			4	Yes		7	None	N/A	N/A		2	2	9	
VIN13*	5 - 7' x 4' CBC	\$260,000	N/A		X					1			3	Kiely Road	No	No		1	2	2	6
VIN14*	6 - 6' x 6' CBC	\$310,000	N/A		X					2			3	Iron Drive	No	No		1	2	2	6
VIN11*	58' span bridge	\$700,000	N/A		X					5			3	Quejette	No	No		1	5	5	9
VIN10*	58' span bridge	\$730,000	N/A		X					1			3	Kiely Road	No	No		1	5	5	9
VIN5	2,054' of Channel Improvements	\$860,000	N/A			X	28			10	Yes		7	None	NA	NA			2	2	9
VIN4*	4,500' of Channel Improvements - property acquisition not included	\$860,000	N/A			X	26			4	Yes		7	None	N/A	N/A			4	4	11
FAB3	Upgrade Fabens Dam	\$1,340,000	N/A	X									20								20
VIN9*	110' span bridge	\$1,410,000	N/A		X					1			3	AP Ramirez	No	No		1	2	2	6
CAN1	Reconstruction of the channel with concrete lining	\$1,440,000	N/A			X	12				Yes		5	Doniphan Drive	No	Yes		2	3	3	10
CAN2	Retention Basin (CAN2B); 1 - 6' x 3' CBC; 143' Channel Improvements; Retention Basin (CAN2A) - 6-foot embankment; 1,665' principal spillway from CAN2A to existing basin	\$4,360,000	N/A	X			52	0			Yes	No	7	Doniphan Drive	No	Yes		2	5	5	14
SSA7	Retention Basin SSA7; Concrete Lined Channel; 6 - 5' x 4' CBC; 6 - 5' x 4' CBC; 6 - 5' x 4' CBC; 6 - 5' x 4' CBC	\$20,300,000	\$12,950,000	X			478	232			Yes	Yes	13	Northloop Drive; Horizon Boulevard	No; No	Yes; Yes		2	5	5	20
VIN1*	Sediment/Detention Basin (VIN1A) - property acquisition not included; Sediment/Detention Basin (VIN1B) - property acquisition not included; 2240' of Channel Improvements	\$21,810,000	\$12,080,000	X			367	0			Yes	Yes	11	Westway	No	Yes		2	4	4	17
VIN2*	950' of Channel Improvements	\$240,000	N/A			X	12			100	Yes		5	None	N/A	N/A			3	3	8
VIN6	3 - 9' x 8' CBC	\$600,000	N/A		X					30			2	Doniphan Drive	No	Yes		2	4	4	8
SSA4	Detention Basin SSA4	\$11,600,000	\$6,380,000	X			268	273		0	No	Yes	12	IH-10	Yes	Yes		2	4	4	18
HAC8	5 - 4' x 4' CBC (In conjunction with HAC2 Basin B)	\$460,000	N/A		X					15			2	Bridgeway Drive	No	Yes		2	2	2	6
SSA2	Detention Basin SSA2	\$4,360,000	N/A	X				116			Yes	Yes	13						4	4	17
SSA5	Sparks Channel; 6 - 10' x 4' CBC	\$8,690,000	N/A			X					Yes		3	IH-10	Yes	Yes		2	5	5	10
HAC2	Sediment/Retention Basin at Location A; Sediment/Retention Basin at Location B	\$10,570,000	\$5,810,000	X			53	214			Yes	Yes	10	IH-10; Bridgeway Drive; Northloop Drive	Yes; No; No	Yes; Yes; Yes		2	3	3	15
SSA1	Detention Basin SSA1	\$22,630,000	\$12,450,000	X			202	756			Yes	Yes	14						4	4	18
TOR6	2 - 4' x 2' CBC	\$50,000	N/A		X					50	Yes		1	None	N/A	N/A			4	4	5
HAC9	3 - 4' x 4' CBC	\$130,000	N/A		X									Northloop Drive	No	Yes		2	2	2	4
CAN3	2 - 6' x 3' CBC	\$140,000	N/A		X						Yes			Doniphan Drive	No	Yes		2	1	1	3
SOC6	2 - 7' x 7' CBC	\$140,000	N/A		X									Coker Road	No	No		1	3	3	4
SOC7	2 - 7' x 7' CBC	\$160,000	N/A		X									Anderson	No	No		1	3	3	4
SOC5	3 - 4' x 4' CBC	\$170,000	N/A		X									Carr Road	No	No		1	3	3	4
VIN12*	3 - 9' x 5' CBC	\$200,000	N/A		X					25			2	IH-10 Of-Ramp	No	Yes		2			4
TOR5	165' of Channel Bank Improvements	\$210,000	N/A			X				100	Yes		3	None	N/A	N/A			4	4	7
SOC8	2 - 7' x 7' CBC	\$220,000	N/A		X									Dirt Road	No	No		1	3	3	4
HAC13	2 - 7' x 7' CBC	\$230,000	N/A		X									Dirt Road	No	No		1	2	2	3
HAC14	2 - 7' x 7' CBC	\$250,000	N/A		X									Celum Road	No	No		1	3	3	4
HAC11	2 - 7' x 7' CBC	\$500,000	N/A		X									None	N/A	N/A			3	3	3
FAB2	Property	\$500,000	N/A			X	N/A	N/A			Yes		3	None	N/A	N/A			3	3	6
HAC12	2 - 7' x 7' CBC	\$550,000	N/A		X									Fenter Road	No	No		1	2	2	3
VIN7*	84' span bridge	\$620,000	N/A		X					20			2	Railroad	N/A	N/A		1			3
HAC1	Low-level/Principal Spillway Outlet	\$750,000	N/A	X			28	0		100	Yes	Yes	8	None	N/A	N/A			3	3	11
TOR2	2,030' of Channel Bank Improvements	\$810,000	N/A			X				100	Yes		3	None	N/A	N/A			2	2	5
SOC3	Sediment/Detention Basin	\$870,000	N/A	X			9	19.2			Yes	Yes	6						4	4	10
SOC4	Sediment/Detention Basin	\$1,180,000	N/A	X			15	21.9			Yes	Yes	6						5	5	11
VIN8*	56' span bridge	\$1,260,000	N/A		X					3			3	Doniphan	No	Yes		2			5
FAB1	Sediment/Retention Basin	\$2,540,000	N/A	X			43	20			Yes	Yes	9	None	N/A	N/A			3	3	12
HAC7	Sediment/Detention Basin at Location A; Sediment/Detention Basin at Location B	\$2,710,000	N/A	X			3	415			Yes	Yes	8	Northloop Drive	No	Yes		2	3	3	13
TOR1	Sediment/Retention Basin (TOR 1 & TOR3) - 6-foot embankment; Sediment Basin (TOR1A)	\$2,430,000	N/A	X			81	0			Yes	Yes	8	None	N/A	N/A			3	3	11
SOC1 and SOC 2	Sediment/Detention Basin - SOC1; Sediment/Detention Basin - SOC2	\$3,640,000	N/A	X			15	20.2			Yes	Yes	6						5	5	11
SSA3	Detention Basin SSA3; Concrete Lined Channel	\$6,170,000	N/A	X			5	170			Yes	Yes	7						3	3	10
TOR3	Sediment Basin (TOR3A)	\$50,000	N/A	X			0	0			No	Yes	1	None	N/A	N/A			3	3	4
HAC10	2 - 7' x 7' CBC	\$520,000	N/A		X									FM 1110	No	No		1			1
TOR4	Sediment/Retention Basin	\$1,340,000	N/A	X			12	0			Yes	Yes	5	None	N/A	N/A			3	3	8

Table C-10. Risk Reduction Benefit (Continued)

Project Number	Description	Estimated Total Cost (Rounded to \$10,000)	Estimated Cost for 254-Year Return Interval Basin Design (Rounded to \$10,000)	Type of Improvement			Flood Risk for Real Property					Arterial Flooding Risk			Maintenance		Total Risk Reduction Benefit		
				Basin	Crossing	Channel	Number of Residences	Acres of Ag Land	Current Protection (Return Period in years)	Are Routine Floods Controlled?	Is Sediment Yield Reduced?	Risk Reduction Benefit	Artery Name	Divided Hwy?	Critical Route?	Risk Reduction Benefit		Current Maintenance Issue (1-5)	Risk Reduction Benefit
HAC4	Sediment/Retention Basin	1,510,000	N/A	X			15	18		Yes	Yes	6	None	N/A	N/A		3	3	9
SSA6	Sediment Basin SSA6_A; North Channel for Basin at Location A; South Channel for Basin at Location A; Sediment Basin SSA6_B; North Channel for Basin at Location B; South Channel for Basin at Location B	1,910,000	N/A	X			0	0		No	Yes	1					3	3	4
HAC3	Sediment/Retention Basin	2,160,000	N/A	X			7	47		Yes	Yes	6	None	N/A	N/A		3	3	9
HAC5	Sediment/Retention Basin	2,340,000	N/A	X			4	52		Yes	Yes	6	None	N/A	N/A		3	3	9
HAC6	Sediment/Retention Basin	\$3,550,000	N/A	X			11	15		Yes	Yes	6	None	N/A	N/A		3	3	9

* Issues, alternatives and cost identified in the City of EL Paso Stormwater Master Plan (SMP).

Table C-11. Total Risk Reduction Benefit

Project Number	Description	Estimated Total Cost (Rounded to \$10,000)	Estimated Cost for 25-Year Return Interval Basin Design (Rounded to \$10,000)	Type of Improvement			Prioritization	
				Basin	Crossing	Channel	Total Risk Reduction Benefit	Category
FAB3	Upgrade Fabens Dam	\$1,340,000	N/A	X			20	I
SSA7	Retention Basin SSA7; Concrete Lined Channel; 6 - 5' x 4' CBC; 6 - 5' x 4' CBC; 6 - 5' x 4' CBC	\$20,300,000	\$12,950,000	X			20	I
SSA4	Detention Basin SSA4	\$11,600,000	\$6,380,000	X			18	I
SSA1	Detention Basin SSA1	\$22,630,000	\$12,450,000	X			18	I
VIN1*	Sediment/Detention Basin (VIN1A) - property acquisition not included; Sediment/Detention Basin (VIN1B) - property acquisition not included; 2,240' of Channel Improvements	\$21,810,000	\$12,080,000	X			17	I
SSA2	Detention Basin SSA2	\$4,360,000	N/A	X			17	I
HAC2	Sediment/Retention Basin at Location A; Sediment/Retention Basin at Location B	\$10,570,000	\$5,810,000	X			15	I
CAN2	Retention Basin (CAN2B); 1 - 6' x 3' CBC; 143' Channel Improvements; Retention Basin (CAN2A) - 6-foot embankment; 1,665' principal spillway from CAN2A to existing basin	\$4,360,000	N/A	X			14	I
HAC7	Sediment/Detention Basin at Location A; Sediment/Detention Basin at Location B	\$2,710,000	N/A	X			13	II
FAB1	Sediment/Retention Basin	\$2,540,000	N/A	X			12	II
HAC1	Low-level/Principal Spillway Outlet	\$750,000	N/A	X			11	II
SOC4	Sediment/Detention Basin	\$1,180,000	N/A	X			11	II
TOR1	Sediment/Retention Basin (TOR 1 & TOR3) - 6-foot embankment; Sediment Basin (TOR1A)	\$2,430,000	N/A	X			11	II
SOC1 and SOC 2	Sediment/Detention Basin - SOC1; Sediment/Detention Basin - SOC2	\$3,640,000	N/A	X			11	II
SOC3	Sediment/Detention Basin	\$870,000	N/A	X			10	II
SSA3	Detention Basin SSA3; Concrete Lined Channel	\$6,170,000	N/A	X			10	II
HAC4	Sediment/Retention Basin	\$1,510,000	N/A	X			9	III
HAC3	Sediment/Retention Basin	\$2,160,000	N/A	X			9	III
HAC5	Sediment/Retention Basin	\$2,340,000	N/A	X			9	III
HAC6	Sediment/Retention Basin	\$3,550,000	N/A	X			9	III
TOR4	Sediment/Retention Basin	\$1,340,000	N/A	X			8	III
TOR3	Sediment Basin (TOR3A)	\$50,000	N/A	X			4	III
SSA6	Sediment Basin SSA6_A; North Channel for Basin at Location A; South Channel for Basin at Location A; Sediment Basin SSA6_B; North Channel for Basin at Location B; South Channel for Basin at Location B	\$1,910,000	N/A	X			4	III

Table C-11. Total Risk Reduction Benefit (Continued)

Project Number	Description	Estimated Total Cost (Rounded to \$10,000)	Estimated Cost for 25-Year Return Interval Basin Design (Rounded to \$10,000)	Type of Improvement			Prioritization	
				Basin	Crossing	Channel	Total Risk Reduction Benefit	Category
VIN11*	58' span bridge	\$700,000	N/A		X		9	I
VIN10*	58' span bridge	\$730,000	N/A		X		9	I
VIN6	3 - 9' x 8' CBC	\$600,000	N/A		X		8	I
VIN13*	5 - 7' x 4' CBC	\$260,000	N/A		X		6	I
VIN14*	6 - 6' x 6' CBC	\$310,000	N/A		X		6	I
VIN9*	110' span bridge	\$1,410,000	N/A		X		6	I
HAC8	5 - 4' x 4' CBC (In conjunction with HAC2 Basin B)	\$460,000	N/A		X		6	I
TOR6	2 - 4' x 2' CBC	\$50,000	N/A		X		5	II
VIN8*	56' span bridge	\$1,260,000	N/A		X		5	II
HAC9	3 - 4' x 4' CBC	\$130,000	N/A		X		4	II
SOC6	2 - 7' x 7' CBC	\$140,000	N/A		X		4	II
SOC7	2 - 7' x 7' CBC	\$160,000	N/A		X		4	II
SOC5	3 - 4' x 4' CBC	\$170,000	N/A		X		4	II
VIN12*	3 - 9' x 5' CBC	\$200,000	N/A		X		4	II
SOC8	2 - 7' x 7' CBC	\$220,000	N/A		X		4	II
HAC14	2 - 7' x 7' CBC	\$250,000	N/A		X		4	II
CAN3	2 - 6' x 3' CBC	\$140,000	N/A		X		3	II
HAC13	2 - 7' x 7' CBC	\$230,000	N/A		X		3	II
HAC11	2 - 7' x 7' CBC	\$500,000	N/A		X		3	II
HAC12	2 - 7' x 7' CBC	\$550,000	N/A		X		3	II
VIN7*	84' span bridge	\$620,000	N/A		X		3	II
HAC10	2 - 7' x 7' CBC	\$520,000	N/A		X		1	III
VIN4*	4,500' of Channel Improvements - property acquisition not included	\$860,000	N/A			X	11	I
CAN1	Reconstruction of the channel with concrete lining	\$1,440,000	N/A			X	10	I
SSA5	Sparks Channel; 6 - 10' x 4' CBC	\$8,690,000	N/A			X	10	I
VIN5	2,054' of Channel Improvements	\$860,000	N/A			X	9	I
VIN3*	1,600' of Channel Improvements	\$120,000	N/A			X	9	I
VIN2*	950' of Channel Improvements	\$240,000	N/A			X	8	I
TOR5	165' of Channel Bank Improvements	\$210,000	N/A			X	7	II
FAB2	Property	\$500,000	N/A			X	6	II
TOR2	2,030' of Channel Bank Improvements	\$810,000	N/A			X	5	II

* Issues, alternatives and cost identified in the City of EL Paso Stormwater Master Plan (SMP).

Table C-12. Prioritization Summary

Project No.	Description	Estimated Total Cost (Rounded to \$10,000)	Estimated Cost for 25-Year Return Interval Basin Design (Rounded to \$10,000)	Type of Improvement			Prioritization	
				Basin	Crossing	Channel	Category	Priority within Category I
VIN3*	1,600' of Channel Improvements	\$120,000	N/A			X	I	high
VIN13*	5 - 7' x 4' CBC	\$260,000	N/A		X		I	high
VIN14*	6 - 6' x 6' CBC	\$310,000	N/A		X		I	high
VIN11*	58' span bridge	\$700,000	N/A		X		I	high
VIN10*	58' span bridge	\$730,000	N/A		X		I	high
VIN5	2,054' of Channel Improvements	\$860,000	N/A			X	I	high
VIN4*	4,500' of Channel Improvements - property acquisition not included	\$860,000	N/A			X	I	high
FAB3	Upgrade Fabens Dam	\$1,340,000	N/A	X			I	high
VIN9*	110' span bridge	\$1,410,000	N/A		X		I	high
CAN1	Reconstruction of the channel with concrete lining	\$1,440,000	N/A			X	I	high
CAN2	Retention Basin (CAN2B); 1 - 6' x 3' CBC; 143' Channel Improvements; Retention Basin (CAN2A) - 6-foot embankment; 1,665' principal spillway from CAN2A to existing basin	\$4,360,000	N/A	X			I	high
SSA7	Retention Basin SSA7; Concrete Lined Channel; 6 - 5' x 4' CBC; 6 - 5' x 4' CBC; 6 - 5' x 4' CBC; 6 - 5' x 4' CBC	\$20,300,000	\$12,950,000	X			I	high
VIN1*	Sediment/Detention Basin (VIN1A) - property acquisition not included; Sediment/Detention Basin (VIN1B) - property acquisition not included; 2,240' of Channel Improvements	\$21,810,000	\$12,080,000	X			I	high
VIN2*	950' of Channel Improvements	\$240,000	N/A			X	I	medium
VIN6	3 - 9' x 8' CBC	\$600,000	N/A		X		I	medium
SSA4	Detention Basin SSA4	\$11,600,000	\$6,380,000	X			I	medium
HAC8	5 - 4' x 4' CBC (In conjunction with HAC2 Basin B)	\$460,000	N/A		X		I	low
SSA2	Detention Basin SSA2	\$4,360,000	N/A	X			I	low
SSA5	Sparks Channel; 6 - 10' x 4' CBC	\$8,690,000	N/A			X	I	low
HAC2	Sediment/Retention Basin at Location A; Sediment/Retention Basin at Location B	\$10,570,000	\$5,810,000	X			I	low
SSA1	Detention Basin SSA1	\$22,630,000	\$12,450,000	X			I	low
TOR6	2 - 4' x 2' CBC	\$50,000	N/A		X		II	
HAC9	3 - 4' x 4' CBC	\$130,000	N/A		X		II	
CAN3	2 - 6' x 3' CBC	\$140,000	N/A		X		II	
SOC6	2 - 7' x 7' CBC	\$140,000	N/A		X		II	
SOC7	2 - 7' x 7' CBC	\$160,000	N/A		X		II	
SOC5	3 - 4' x 4' CBC	\$170,000	N/A		X		II	
VIN12*	3 - 9' x 5' CBC	\$200,000	N/A		X		II	
TOR5	165' of Channel Bank Improvements	\$210,000	N/A			X	II	
SOC8	2 - 7' x 7' CBC	\$220,000	N/A		X		II	

Table C-12. Prioritization Summary (Continued)

Project No.	Description	Estimated Total Cost (Rounded to \$10,000)	Estimated Cost for 25-Year Return Interval Basin Design (Rounded to \$10,000)	Type of Improvement			Prioritization	
				Basin	Crossing	Channel	Category	Priority within Category I
HAC13	2 - 7' x 7' CBC	\$230,000	N/A		X		II	
HAC14	2 - 7' x 7' CBC	\$250,000	N/A		X		II	
HAC11	2 - 7' x 7' CBC	\$500,000	N/A		X		II	
FAB2	Property	\$500,000	N/A			X	II	
HAC12	2 - 7' x 7' CBC	\$550,000	N/A		X		II	
VIN7*	84' span bridge	\$620,000	N/A		X		II	
HAC1	Low-level/Principal Spillway Outlet	\$750,000	N/A	X			II	
TOR2	2,030' of Channel Bank Improvements	\$810,000	N/A			X	II	
SOC3	Sediment/Detention Basin	\$870,000	N/A	X			II	
SOC4	Sediment/Detention Basin	\$1,180,000	N/A	X			II	
VIN8*	56' span bridge	\$1,260,000	N/A		X		II	
FAB1	Sediment/Retention Basin	\$2,540,000	N/A	X			II	
HAC7	Sediment/Detention Basin at Location A; Sediment/Detention Basin at Location B	\$2,710,000	N/A	X			II	
TOR1	Sediment/Retention Basin (TOR 1 & TOR3) - 6-foot embankment; Sediment Basin (TOR1A)	\$2,430,000	N/A	X			II	
SOC1 and SOC 2	Sediment/Detention Basin - SOC1; Sediment/Detention Basin - SOC2	\$3,650,000	N/A	X			II	
SSA3	Detention Basin SSA3; Concrete Lined Channel	\$6,170,000	N/A	X			II	
TOR3	Sediment Basin (TOR3A)	\$50,000	N/A	X			III	
HAC10	2 - 7' x 7' CBC	\$520,000	N/A		X		III	
TOR4	Sediment/Retention Basin	\$1,340,000	N/A	X			III	
HAC4	Sediment/Retention Basin	\$1,510,000	N/A	X			III	
SSA6	Sediment Basin SSA6_A; North Channel for Basin at Location A; South Channel for Basin at Location A; Sediment Basin SSA6_B; North Channel for Basin at Location B; South Channel for Basin at Location B	\$1,910,000	N/A	X			III	
HAC3	Sediment/Retention Basin	\$2,160,000	N/A	X			III	
HAC5	Sediment/Retention Basin	\$2,340,000	N/A	X			III	
HAC6	Sediment/Retention Basin	\$3,550,000	N/A	X			III	

* Issues, alternatives and cost identified in the City of EL Paso Stormwater Master Plan (SMP).

FIGURES

This page was intentionally left blank.

Figure C-1. Cost per Square Foot of Flow Area vs. Flow Area of Culverts

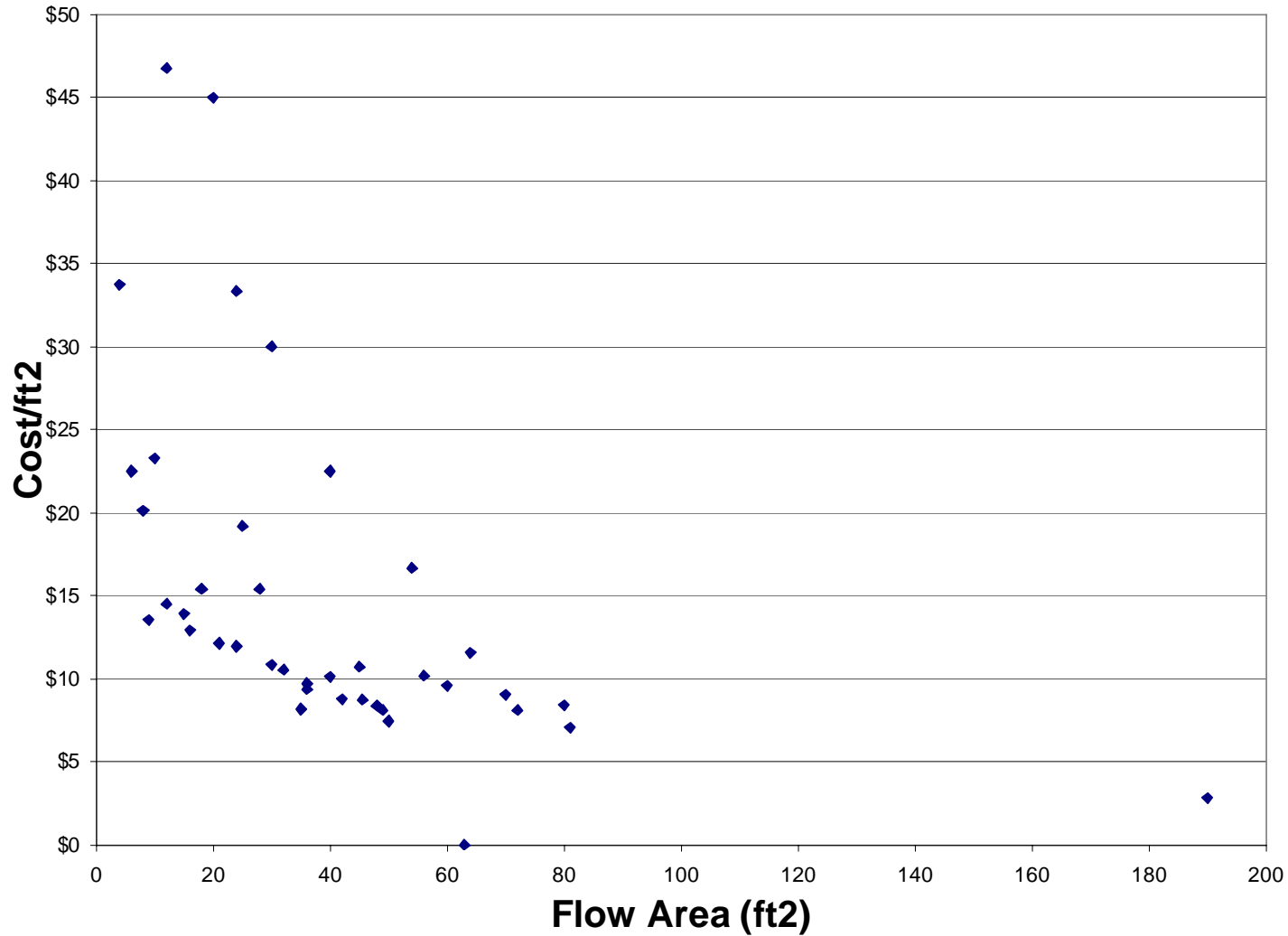

Figure C-2. URS Basin Conceptual Design Embankment Stabilization Materials

